

Report No. CG-D-05-91

AD-A241 284



LIFTBOAT LEG STRENGTH STRUCTURAL ANALYSIS

W.P. Stewart, P.E.
Stewart Technology Associates
5011 Darnell
Houston, TX 77096



FINAL REPORT
JULY 1991

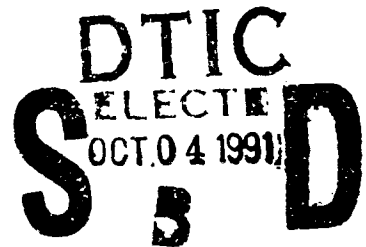

This document is available to the U.S. public through the
National Technical Information Service, Springfield, Virginia 22161

Prepared for:

U.S. Coast Guard
Research and Development Center
1082 Shennecossett Road
Groton, Connecticut 06340-6096

and

U.S. Department Of Transportation
United States Coast Guard
Office of Engineering, Logistics, and Development
Washington, DC 20593-0001

91-12056



DISTRIBUTION STATEMENT A

Approved for public release;
Distribution Unlimited

NOTICE

This document is disseminated under the sponsorship of the Department of Transportation in the interest of information exchange. The United States Government assumes no liability for its contents or use thereof.

The United States Government does not endorse products or manufacturers. Trade or manufacturers' names appear herein solely because they are considered essential to the object of this report.

The contents of this report reflect the views of the Coast Guard Research and Development Center, which is responsible for the facts and accuracy of data presented. This report does not constitute a standard, specification, or regulation.

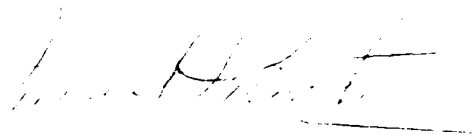

SAMUEL F. POWEL, III
Technical Director
U.S. Coast Guard Research and Development Center
Avery Point, Groton, Connecticut 06340-6096



Technical Report Documentation Page

1. Report No. CG-D-05-91		2. Government Accession No.		3. Recipient's Catalog No.	
4. Title and Subtitle Liftboat Leg Strength Structural Analysis				5. Report Date July 1991	
				6. Performing Organization Code	
7. Author(s) William P. Stewart				8. Performing Organization Report No. R&DC 02/91	
9. Performing Organization Name and Address Stewart Technology Associates 5011 Darnell Houston, TX 77096				10. Work Unit No. (TR AIS)	
				11. Contract or Grant No. DTCG39-89-C-80825	
				13. Type of Report and Period Covered Final Report	
12. Sponsoring Agency Name and Address U.S. Coast Guard Research and Development Center 1082 Shennecossett Road Groton, Connecticut 06340-6096		Department of Transportation U.S. Coast Guard Office of Engineering, Logistics, and Development Washington, D.C. 20593-0001		14. Sponsoring Agency Code	
15. Supplementary Notes An interim report, produced as part of this project in February 1990, provides additional information on this same subject.					
16. Abstract Liftboats are self-propelled vessels with barge-shaped hulls which operate in coastal and near-shore areas. They have three (sometimes four) legs which are jacked down when they are on location, and the hull is then raised out of the water to serve as a stable work platform. The legs have large pads at their bases which allow them to rest on the sea bed with relatively small penetration even in soft soil conditions. This report investigates the strength of the legs of typical liftboats. The load induced in the legs comes from self-weight, wind, wave, and current loads. Rather large lateral deflections of the hull, which may be amplified dynamically, cause secondary bending stresses in the legs. This is often simply referred to as the P-delta effect. A calculation procedure is presented with numerous examples, showing how to include all important terms, including the P-delta effect, Euler amplification, and leg fixity at the hull and at the sea bed.					
17. Key Words Liftboats, K-factors Structural Analysis Wave Loads Wind Loads			18. Distribution Statement Document is available to the U.S. public through the National Technical Information Service, Springfield, Virginia 22161		
19. Security Classif. (of this report) UNCLASSIFIED		20. SECURITY CLASSIF. (of this page) UNCLASSIFIED		21. No. of Pages	22. Price

METRIC CONVERSION FACTORS

Approximate Conversions to Metric Measures				Approximate Conversions from Metric Measures			
Symbol	When You Know	Multiply By	To Find	Symbol	When You Know	Multiply By	To Find
LENGTH * 2.5 30 0.9 1.6				LENGTH 0.04 0.4 3.3 1.1 0.6			
in	inches	centimeters	cm	mm	millimeters		inches
ft	feet	centimeters	cm	cm	centimeters		inches
yd	yards	meters	m	m	meters		feet
mi	miles	kilometers	km	km	kilometers		yards
AREA 6.5 0.09 0.8 2.6 0.4				AREA 0.16 1.2 0.4 2.5			
in ²	square inches	square centimeters	cm ²	cm ²	square centimeters		square inches
ft ²	square feet	square meters	m ²	m ²	square meters		square yards
yd ²	square yards	square meters	m ²	km ²	square kilometers		square miles
mi ²	square miles	square kilometers	km ²	ha	hectares (10,000 m ²)		acres
MASS (WEIGHT) 28 0.45 0.9				MASS (WEIGHT) 0.035 2.2 1.1			
oz	ounces	grams	g	g	grams		ounces
lb	pounds	kilograms	kg	kg	kilograms		pounds
	short tons (2000 lb)	tonnes	t	t	tonnes (1000 kg)		short tons
VOLUME 5 15 30 0.24 0.47 0.95 3.8 0.03 0.76				VOLUME 0.03 0.125 2.1 1.06 0.26 35 1.3			
tsp	teaspoons	milliliters	ml	ml	milliliters		fluid ounces
tbsp	tablespoons	milliliters	ml	l	liters		cups
fl oz	fluid ounces	milliliters	ml	l	liters		pints
c	cups	liters	l	l	liters		quarts
pt	pints	liters	l	l	liters		gallons
qt	quarts	liters	l	m ³	cubic meters		fluid feet
gal	gallons	liters	l	m ³	cubic meters		fluid yards
ft ³	cubic feet	cubic meters	m ³				
yd ³	cubic yards	cubic meters	m ³				
TEMPERATURE (EXACT) Fahrenheit temperature 5/9 (after subtracting 32) Celsius temperature				TEMPERATURE (EXACT) Celsius temperature 9/5 (then add 32) Fahrenheit temperature			
°F	Fahrenheit temperature	Celsius temperature	°C	°C	Celsius temperature		Fahrenheit temperature

* 1 in = 2.54 (exactly) For other exact conversions and more detailed tables, see NBS Misc. Publ 286, Units of Weights and Measures. Price \$2.25. SD Catalog No. C-13 10 286

CONTENTS

<u>Section & Subject</u>	<u>Page #</u>
1.0 INTRODUCTION.....	1
2.0 ENVIRONMENTAL LOADING AND DESIGN CRITERIA.....	3
3.0 STRUCTURAL MODELING.....	5
3.1 Computer Program	5
3.2 Comparison With Finite Element Analysis.....	6
3.3 Leg End Fixity and Effective Length Factors	6
3.4 Effects of Rack Eccentricity in Jacking Towers	7
4.0 STRUCTURAL RESPONSE.....	9
4.1 The P-Delta Effect.....	9
4.2 Prediction of Secondary Bending Effects	10
5.0 COMPONENTS OF MAXIMUM LEG STRESS.....	11
5.1 Leg Stress Checks Required	13
6.0 LIFTBOAT DESIGN TO SATISFY DESIGN CRITERIA.....	16
7.0 SUMMARY AND CONCLUSIONS.....	19
8.0 REFERENCES.....	24

FIGURES

APPENDIX 1	<i>WIND LOADING METHODOLOGY.....</i>	<i>A1-1</i>
APPENDIX 2	<i>WAVE LOADING METHODOLOGY.....</i>	<i>A2-1</i>
APPENDIX 3	<i>GEOTECHNICAL CONSIDERATIONS.....</i>	<i>A3-1</i>
APPENDIX 4	<i>COMPUTER PROGRAM FOR ANALYSIS OF LIFTBOATS.....</i>	<i>A4-1</i>
APPENDIX 5	<i>PROGRAM COMPARISON WITH FINITE ELEMENT SOLUTION.....</i>	<i>A5-1</i>
APPENDIX 6	<i>SECONDARY BENDING ANALYSIS TECHNIQUES.....</i>	<i>A6-1</i>
APPENDIX 7	<i>CALCULATION OF TORSIONAL RESPONSE.....</i>	<i>A7-1</i>
APPENDIX 8	<i>DISTRIBUTED VERSUS POINT LOAD APPLICATIONS.....</i>	<i>A8-1</i>
APPENDIX 9	<i>ITERATIVE SOLUTION FOR P-DELTA EFFECT.....</i>	<i>A9-1</i>
APPENDIX 10	<i>SINGLE RACK ECCENTRICITY EFFECTS.....</i>	<i>A10-1</i>

<input checked="" type="checkbox"/>
<input type="checkbox"/>
<input type="checkbox"/>

Codes

Dist	Avail and/or Special
A-1	

PREFACE

A liftboat is a self-propelled floating platform capable of carrying crew and supplies to a desired location, and raising itself above the water by "jacking down" three or more vertical legs and "jacking up" its hull. (See Figure 1.) Once elevated, it becomes an offshore platform resting on the sea bottom, which can be used as temporary crew quarters while it provides maintenance, supplies and other support services to larger, fixed platforms. When its mission is accomplished, the vessel can "jack down", as long as the waves are below 5-6 feet in height, and return for additional supplies, or move to another site.

When extremely severe weather conditions are forecast, the vessel may try to jack down before finishing its mission, and return to port before the storm arrives. Failing this, the crew can be evacuated by helicopter and the rig left unattended to ride out the storm. Numerous rig failures have occurred during hurricane conditions. Rig failures may also occur in less severe conditions due to failure of the jacking mechanism, legs becoming stuck in the bottom, or the numerous other causes which afflict conventional vessels.

The Coast Guard R&D Center has surveyed a variety of liftboat casualty reports. Between 1980-1987, 46 major rig casualties were identified, out of an estimated fleet of 250 liftboats, a casualty rate of 18%. These casualty reports were surveyed and grouped according to primary cause as follows:

Cause	Number	% Of Total Casualties
Leg Failure	14	30
Jacking Failure	9	20
Footing Failure	7	15
Human Error	6	13
Damaged Stability	5	11
Intact Stability	2	4
Other Causes	3	7

It was often not possible from the accident reports to distinguish between cases where the rig tipped over and cases where structural failure of the legs preceded collapse. Thus both causes are reported above as "leg failure". Additional details of this survey are available from the Coast Guard R&D Center.

Based on this survey, leg failure was considered the area most in need of further study. The American Bureau of Shipping (ABS) uses its rules for mobile offshore drilling units (MODUs) when classifying liftboats, but many of the liftboats in the survey above were unclassified. The Coast Guard has since proposed regulations to require classification of liftboats under the ABS MODU Rules. These include rules to prevent overturning and leg buckling. The rules for prevention of leg buckling require the designer to assess an "effective length factor" (K-factor), when performing a buckling check. This factor depends on the boundary conditions at the top and bottom of the legs and is extremely difficult to calculate rigorously. The R&D Center contracted with Stewart Technology Associates to perform an assessment of the ABS MODU Rules, particularly those associated with leg failure. The following report provides the results of that study.

1.0 INTRODUCTION

This Final Report follows two earlier reports (References 1 and 2, available by request from USCG R&D Center) which were produced as part of this project which has been sponsored by the US Coast Guard, Research and Development Center, Groton, CT. The main objective of the work is to establish rational analysis procedures for liftboat structures in the elevated condition.

In the first part of this project the environmental loading methodology was established for liftboats. The important aspects of this earlier work are reviewed in this Final Report.

In the second part of this project, the sensitivity of liftboat survivability to variation in the effective length, or K-factor, for the legs was investigated. Additionally the influence of leg diameter and wall thickness was considered. The important aspects of this earlier work are reviewed in this Final Report.

Earlier work has centered upon a generic liftboat defined by the Coast Guard. This vessel has principal characteristics as shown in Table 1.1, below, and as further defined in Figures 1, 2, 3, and 4.

TABLE 1.1

LOA	90.0 ft
Maximum Beam	42.0 ft
Distance between forward leg centers	50.0 ft
Distance from fwd. leg centers to aft leg center	66.0 ft
LCG (fwd. of stern leg center)	40.0 ft
TCG (on vessel centerline)	0.0 ft
Displacement (max)	650 kips
Lightship weight	525 kips
Leg Length	130.0 ft
Leg Diameter (O.D.)	42.0 in
Leg Wall Thickness	0.5 in
Yield strength of steel in legs	50 ksi

Note that the actual elevated condition can vary from anywhere between the minimum of lightship weight (525 kips) to full displacement weight (650 kips). The difference between these two weights represents the variable load capacity of the unit. For examination of the elevated stability a condition of lightship plus 10% of the maximum variable load has generally been taken. This gives a total

weight of $525 + 12.5 = 537.5$ kips. For computations of leg strength, 100% of the variable load has been used.

In the Interim Report (Reference 1) it was shown that the generic liftboat design did not meet the target design criteria. In the second report (Reference 2) it was shown that changes in the leg design could improve the survivability of the generic liftboat. A new design for the legs, together with a significant increase in elevated weight, described in this report is shown to satisfy the target design criteria (detailed in Section 2.0).

Information presented in this document includes;

- ***a review of environmental loading and recommended design criteria (Section 2)***
- ***description of structural analysis procedures for liftboat analysis (Section 3)***
- ***comparison of recommended procedures with finite element solution (Section 3.2)***
- ***recommended end fixity conditions for leg design (Section 3.3)***
- ***explanation of rack eccentricity effects in jacking towers (Section 3.4)***
- ***a detailed explanation of the so-called P-delta effect (Section 4.1)***
- ***alternative approaches to secondary bending calculations (Section 4.2)***
- ***comparison of relative contributions to maximum leg stresses (Section 5)***
- ***leg stress checks required (Section 5.1)***
- ***a generic liftboat design that satisfies the target design criteria (Section 6)***

Much of the detailed information in this document is contained in the appendices, to which reference is made in the sections noted above.

2.0 ENVIRONMENTAL LOADING AND DESIGN CRITERIA

The method of wind loading is described in detail in Reference 1 and important points are reviewed in Appendix 1. Similarly the method of wave and current loading, including a current and wave combination technique, is described in detail in Reference 1, while important points are reviewed in Appendix 2. In all cases, for liftboats, ABS shallow water wave theory (Reference 3) is recommended.

Calculating environmental loads on a liftboat is relatively straight forward once the criteria for the environment have been defined. In deep water, waves and current may induce larger forces and moments than those induced by the wind. Additionally the wave forces may cause significant dynamic response. This is discussed later. In shallow water the dominant force comes from the wind.

The conditions suggested by the Coast Guard for the analysis of the Generic Liftboat were as described in Table 2.1, below:

TABLE 2.1

Parameter	Shallow	Deep
Basic water depth	20.0 ft	60.0 ft
Tidal rise	2.0 ft	2.0 ft
Storm tide (or surge)	15.0 ft	3.0 ft
Total water depth for analysis	37.0 ft	65.0 ft
Air gap for analysis (above max. water)	20.0 ft	20.0 ft
Current speed	2.0 knots	2.0 knots
Wind speed	70.0 knots	70.0 knots
Wave height	20.0 ft	20.0 ft
Wave period	10.0 sec.	10.0 sec.
Footing penetration into sea bed	3.0 ft	3.0 ft

It is recommended that the environmental conditions for liftboat "restricted" design and regulatory approval are based upon a 1-year return period criterion. In the Gulf of Mexico this may be represented by a 70 knot wind speed, a 1.7 knot current, and 1-year return period wave height. For "unrestricted" liftboat design and regulatory approval, a 100 knot wind speed, a 2.5 knot current, and 100-year return period wave height are recommended. For different geographic locations where a liftboat is to operate, the 1-year and 100-year return period wave characteristics must be defined. Tables linking the height and period of 1-year and 100-year waves to water depths in the Gulf of Mexico are provided in Section 7 of this report. These tables are based on the work reported in Reference 7. The logic behind these recommendations is two-fold. The first

reason is that the criteria are realistic. Wind speeds in excess of 70 knots occur many times every year during thunderstorms in nearshore waters in the Gulf of Mexico. There are several recorded incidents in the last few years where liftboats have experienced wind speeds in excess of 100 knots in thunderstorms in nearshore locations in the Gulf. However, wave heights during thunderstorms are frequently relatively low (compared to those 1-year wave heights shown in Table 7.2), consequently a liftboat designed for 1-year waves and 70 knot winds will be able to resist forces from winds in excess of 70 knots if they are accompanied by only relatively small waves. The second reason is that it establishes similar design environmental criteria for both the afloat and the elevated conditions, and will minimize the probability of the hull being lowered into the water in marginal conditions.

In order to determine if a liftboat design can meet a given set of design conditions, the following three fundamental criteria need to be satisfied:

- (1) *The factor of safety against overturning should be equal to or greater than 1.1 (Reference 3);*
- (2) *The maximum vertical reaction on any pad should not exceed the maximum vertical reaction achieved during preloading (Reference 3)*;*
- (3) *No over-stress or leg buckling should occur.*

** The underlying requirement is for either no further pad penetration, or for any further penetration to be tolerable. Some factor of safety must be used.*

It is important to note that the direction of loading that causes the greatest overturning moment is not the same as that which causes the greatest footing reaction. It may not also be the direction of loading as that which causes the greatest stress in the liftboat legs. Much of the work in this project has focused upon determining the maximum overturning moment acting on a liftboat. Because of the geometry and mass-distribution of the generic liftboat, the critical direction for the forces causing this overturning moment is perpendicular to the line joining the aft leg and one of the forward legs. When the loading comes from this direction, two legs, to the leeward side of the vessel, pick up increased vertical reactions and one leg, to the windward side of the vessel, has reduced vertical loading. Overturning occurs at a point where the vertical reaction on the windward leg reduces to zero. For other liftboats, loading from the stern, towards the forward pair of legs may be critical.

The maximum vertical reaction on any liftboat pad occurs when the loading is either parallel to the center line of the liftboat coming from the bow, or when the loading is perpendicular to a line joining one of the forward legs with the aft leg. In this case the loading direction is opposite to that in the paragraph above which causes maximum overturning forces.

The direction for environmental loading which causes the maximum stress in the liftboat legs is not obvious. Several directions must be investigated. There is a tendency for the maximum load direction to be the same as that which results in

maximum response. This direction is typically that which presents the largest wind area and this is normally the beam direction. However, it should be noted that for the generic liftboat the strongest axis of the legs (for the leg pair at the bow) is the transverse direction. Consequently, response to beam loading on the bow legs is significantly less than response to beam loading on the stern leg. For the generic liftboat this is frequently the most severe load direction for the stern leg.

3.0 STRUCTURAL MODELING

In this contract the hull of the liftboat has been specified to be infinitely rigid. The response of the liftboat has been calculated principally as a function of leg stiffness. Upper and lower leg fixities are important considerations.

At the hull the leg is not completely fixed. Vertical reactions are taken by the pinions and the rack at a point between the guides. Horizontal reactions are taken at the upper and lower guides. Between the guides the leg may flex. A detailed explanation of how to handle the global structural analysis of these conditions is provided in Appendix 6.

At the sea bed the leg is supported by a foundation pad to which it is welded. The pad is restrained against movement by the seabed soil. This restraint is difficult to calculate and guidance is given on this in Appendix 3, "Geotechnical Calculations", in Appendix 6, page A6-9, "Calculation of Rotational Stiffness of Footing" and on page A6-12, "Calculation of Footing Ultimate Moment Capacity".

Liftboat legs are generally cylindrical but because of the rack(s) the leg structural properties are different in the fore/aft and the lateral directions (as are hydrodynamic drag properties). This difference in structural properties must be accounted for carefully in the structural model since it not only leads to important changes in the overall structural response but it leads also to large changes in the maximum stresses induced in the legs. Further guidance is provided in Appendix 2, Appendix 4, page 6, and in Reference 1. The effects of roughness and marine growth are described in Appendix 4.

3.1 Computer Program

Because of the number of load cases that must be investigated in order to determine the adequacy of any liftboat design, a computer program is necessary. Such a program must include environmental loading, static and, in some cases, dynamic response analysis.

In this project an existing series of programs, originally designed and used for the analysis of jack-up rigs, has been tailored specifically to the analysis of liftboats. The resulting program, STA LIFTBOAT, is fully described in Appendix 4, which also serves as a guide to the analysis procedures recommended in this report. The principal input to the program is shown in Figure 5. The standard form of output from the program is shown in Figure 7.

Note that the main input shown in Figure 5 is supplemented by structural input data which is shown in Figure 6. In Figure 6 the user specifies the leg section properties and the program calculates a lateral stiffness for the leg based upon the shear flexibility and the bending flexibility of the leg. Note that the overall lateral stiffness is reduced by the axial load applied to the leg. This is sometimes referred to as Euler amplification of the response. The methodology used is fully described in Appendix 4 which also serves as a user manual for the liftboat analysis program.

Once the structural file for a particular liftboat is set up, the user does not need to change any terms other than those shown highlighted in Figure 5 and the upper section of Figure 6 when additional runs are performed. Note that the highlighted cells in Figure 6 contain terms which affect the response only. The highlighted cells in Figure 5 affect the loading only.

3.2 Comparison with Finite Element Analysis

The program used for liftboat analysis, embodying the recommended analysis procedures, has been compared with a detailed finite element model for one critical loading condition. The comparison is very good. The principal difference in the first order terms comes from the calculation of horizontal footing reactions. In the program STA LIFTBOAT, a simplifying assumption is made that the horizontal reactions at the footings are all equal. This is similar to the assumptions normally made in the analysis of larger jack-up rigs in design wave conditions. While the wave length is long in comparison to the leg spacing this assumption is good. Also, where the response contains significant dynamics, this is usually a good assumption. The assumption becomes invalid in very short waves where the wave length is commensurate with the leg spacing. Details of the comparison are given in Appendix 5.

It should be noted that linear finite element analysis does not normally account for the secondary bending effects which are automatically accounted for by STA LIFTBOAT. Secondary bending effects are explained further in Section 4.1. The magnitude of stresses induced by the secondary bending terms is generally significantly greater than the difference in stresses caused by an assumption of equal horizontal reactions compared to the real case of different horizontal reactions at footings.

3.3 Leg End Fixity and Effective Length Factors

For design purposes, safety factors and maximum leg stresses for typical liftboats should be checked with an effective length factor not less than 2.0 in the maximum design environmental conditions. In order to determine realistic maximum leg forces, moments, and induced stresses, the upper and lower guide restraints should be carefully modelled. If the bottom of the leg is treated as pin-jointed the effective length will be greater than 2.0. Hence some soil restraint to the pad should be modeled by a rotational spring at the bottom of the leg. The

value of the stiffness of this spring should be such that the effective length factor for the leg is no less than 2.0, calculated by the method explained in Appendix 6, page A6-6. This will generally be conservative for conditions where the soil is of uniform strength and evenly distributed beneath the liftboat pads. However, liftboats are frequently operated in areas of uneven sea bed and are occasionally elevated with one or more pads inadvertently placed on top of debris on the sea bed. In such cases the pads will be unevenly loaded, additional bending moments may be induced in the legs, and soil rotational restraint may be reduced to near zero at a particular pad. Keeping the K-factor at 2.0 provides a margin of safety for conditions of uneven pad support.

Appendix 3 reviews geotechnical considerations at the liftboat pads and shows the maximum K-factors that may be anticipated in different conditions (based upon the ultimate moment capacity of the foundation). In mild environmental conditions, or in shallow water (compared to the design water depth) the K-factor may become quite low without the moment at the footing exceeding the ultimate capacity of the foundation (minimum value shown in Appendix 6 is 1.21). However in storm conditions, at the boat's design maximum water depth, the minimum K-factor, without exceeding the soil ultimate moment capacity is found to be 1.84 for the new design of leg with 1 inch wall thickness (see Section 6) and 1.86 for the original 1/2 inch leg. A retrospective analysis of four liftboats during Hurricane Juan, using the program STA LIFTBOAT is presented in Reference 8. K-factors as low as 1.19 and as high as 1.97 were found for liftboats in water depths of 25 feet and 80 feet, respectively.

In addition to considering low soil rotational restraint at the pads, the designer should consider the rather high stresses that may be induced in the leg at the connection to the pad by strong soils. Although the leg may be able to resist the stresses induced by the maximum design environmental conditions if it is considered fully restrained at the pad, low cycle, high stress-range fatigue damage may lead to premature failure at this location unless the designer has accounted for the potentially large stresses in this area under normal operating conditions. With the leg fully fixed at the sea bed, an effective length factor of as low as 1.05 may be achieved, depending on the guide spacing and leg design. In such a case the bending moment at the leg connection to the pad may exceed that at the lower guide location at the hull.

The welded connections of the braces from the top of the jacking towers to the deck plating may be subject to fatigue damage, both from stresses induced while elevated, and from stresses induced during transit. The connections offer easy access for inspection and frequent visual inspection is strongly recommended.

3.4 Effects of Rack Eccentricity In Jacking Towers

A single rack induces an "eccentric" loading into the leg. However, this does not result in a moment at the lower guide equal to the applied vertical pinion load multiplied by the distance of the pinions' average contact point distance (on the rack) from the leg centerline. The vertical pinion loads spread from the rack into

the leg cylindrical shell structure and cause local stress gradients which are generally small at the location of the lower guide. Unacceptably high stresses may occur at the rack with uneven pinion loads, possibly resulting in yielding of the rack or breaking of pinion teeth. Similarly, with deformed or badly worn guides, locally high contact stresses may be induced, reducing the leg's buckling capacity.

A moderately detailed finite element structural model of a liftboat leg has been developed. Three-dimensional thin shell elements are used in conjunction with local 3-D beam elements in the area of the pinions, upper and lower guides. Fourteen feet below the lower guide the plate and beam elements are kinematically constrained to the top of a cylindrical pipe element which is pinned at its lower end, 88 feet below the lower guide. The upper and lower guide stiffnesses are represented by a series of small 3-D beam elements restrained at their opposite ends to zero displacements in the x-direction. Results are shown in Appendix 10 for the original 42-inch OD leg with 0.5 inch wall thickness and for the re-designed 1.0 inch thickness leg (see Section 6).

In the cases modeled, the pinions are closer to the top guide (in the top one third of the guide spacing). Axial stresses are increased in the immediate area of the rack, below the pinions. At the level of the lower guide the maximum plate stresses are about 45% greater than a uniformly distributed axial stress would be. In the cylinder wall on the opposite side to the rack, a reaction against the lower guide induces stresses which total (Von Mises stress combination) only about 20% greater than an equivalent uniformly distributed axial stress.

The finite element model is rather coarse in the area of the guides and the rack and it is possible that higher than actual stresses are being predicted (in the area of the guides in particular) by the model. If bending stresses had been calculated using simple beam theory, then the combined "axial and bending" stress on the rack side would have been over-estimated by approximately 100%.

Effects of friction have not been included in the FE model. While these effects will not allow vertical load transfer to the guides in an oscillatory load situation (except, perhaps for loading in the plane of the rack) friction effects will constrain lateral movement of the rack at the pinions, forcing the leg against the opposite face of the jacking tower. This effect may be beneficial in reducing axial stresses on the rack side as there will be some vertical load transfer to the wall of the jacking tower. However, this load will initially be in the opposite direction to that desired, since friction forces oppose the jacking forces while elevating. If the jacks are relaxed after elevating is complete, or if some creep occurs, friction forces in the opposite wall may reduce axial stresses in the wall on the rack side. The compression forces of the pinions loading the leg against the opposite wall have not been included in the FE model as these stresses should not influence conditions at the lower guide.

If the stress increases (above uniform axial) in the FE model are attributed to a bending effect, they may be compared with and added to the bending stresses induced by environmental loading. Figure 7 (see Section 6) shows a bending stress of a maximum of around 25 ksi at the lower guide, induced by the "design"

storm load. This maximum bending stress is associated with a simultaneous maximum axial load at the hull of around 350 kips. The results in Figure 7 do not include the "eccentricity effect" of the rack and pinion loads. In the finite element study a vertical pinion load of 300 kips was used, and the component of stress due to "bending" was found to be approximately 1 ksi. Hence the actual bending stress (assuming the worst case combination of all terms) should be increased from around 25 ksi by approximately 1 ksi. This has the effect of increasing the unity check from a maximum of 0.93 to 0.955, which is less than a 3% increase.

It is recommended that further study of the rack "eccentricity" effects is undertaken before a general correction term for leg stresses is suggested. For the time being it can be assumed that the effect is generally small.

4.0 STRUCTURAL RESPONSE

Liftboats, like jack ups, respond significantly to environmental loading in the elevated mode. They are relatively flexible structures supported by three legs (sometimes four) and they respond both statically and dynamically, principally by lateral swaying motion. The sway response is a function both of the lateral loads and the axial loads on the legs. Axial loads on the legs come from self-weight and weight of variable loads carried on the vessel. Figure 7 includes the principal response terms that are important in a liftboat analysis (elevated conditions). The important terms are as follows:

- Sway of the hull laterally, mean value*
- Sway of the hull laterally, amplitude*
- Vertical reactions at footings*
- Horizontal reactions at footings*
- Rotation of footings*
- Bending moment induced at bottom of leg*
- Bending moment induced at lower guide*
- Maximum stress induced at lower guide*
- Maximum stress induced at bottom of leg*

4.1 P-Delta Effect

The P-delta effect, as it applies to liftboats, may be defined as the effect of increased bending moments, and hence stresses, in the liftboat legs as a consequence of the lateral sway deflection of the hull. Euler amplification is a term used to describe the increased lateral deflection (or reduced lateral stiffness) of frames with columns having axial loads. In other words, an axially loaded column will deflect more than a column without axial load when subjected to lateral force. Figure 8 illustrates the concept of the P-delta effect with a 2-dimensional frame, showing an exaggerated lateral sway through a distance **delta**. The footing reaction on the right, R2, has been increased and that on the left, R1, has been decreased.

The reactions are given by:

$$R1 = W/2 - W.\mathbf{delta}/a - P.I/a$$

$$R2 = W/2 + W.\mathbf{delta}/a + P.I/a$$

Where:

- P = applied lateral load to top of frame
- W = weight of frame (all weight in top for this example)
- a = distance between (pin-jointed, in this example) supports
- I = length of legs of frame

At the top of the legs the bending moments are given by:

$$M1 = P.I/2 + R1.\mathbf{delta}$$

$$M2 = P.I/2 + R2.\mathbf{delta}$$

It can be seen from the preceding equations that the term **delta** causes the largest vertical footing reaction to increase further (than would be predicted for a rigid laterally and vertically loaded frame) and causes the smallest vertical footing reaction to decrease further (than would be predicted for a rigid frame) when the horizontal load, P, is applied. It can also be seen that the moment at the top of both legs is increased because of the term **delta**.

The P-delta effect is most pronounced with large axial loads (large values of W) and with slender flexible legs. The direct consequence of the P-delta effect on the response of a liftboat, is to significantly increase lateral sway, leg bending moments, and leg stresses. The increase is in comparison to those values that would be predicted by analysis procedures that omit consideration of the serious reduction in lateral stiffness caused by axial loading.

4.2 Prediction of Secondary Bending Effects

Secondary bending effects are generally not correctly accounted for in popular and well-respected structural analysis computer programs. The so-called P-delta effect is generally regarded as a non-linear effect and precludes the solution to structural response by inversion of a linear stiffness matrix, the most common solution technique adopted in finite element structural programs. The requirement to develop an iterative technique to solve the secondary bending problems associated with liftboat analysis was an original part of this contract.

If the leg, or frame, stiffness is calculated without consideration of axial stiffness reductions, the calculation of deflection (as a consequence of a horizontal load) will be underestimated. An iterative procedure can be used to find the final deflected position. The axial load applied at the top of the leg causes a secondary bending moment when the leg is deflected by the horizontal load. This secondary bending moment at the top of the leg itself causes a further

deflection of the leg. The leg is then subject to an increased secondary bending moment and deflects further. A method for calculating the secondary bending using this iterative approach is compared in Appendix 9 to the direct solution method recommended, which is explained in detail in Appendix 6.

The method recommended for deflection calculation and stress analysis uses equations for leg/hull lateral stiffness which include reduction factors accounting for the influence of axial loads. The solution is direct and does not require iteration. The methods used are fully described in Appendix 4 and in Appendix 6, where several solution techniques for different components of the secondary bending stress problem are explained in detail.

5.0 COMPONENTS OF MAXIMUM LEG STRESS

Methods for calculating liftboat loading and response have been described in detail in this document and in References 1 and 5. The need for several uncommon analysis procedures has been emphasized. The following procedures are required:

- establish leg drag and mass coefficients, plus wind areas*
- calculate distributed loads throughout one wave cycle*
- establish end constraints at top and bottom of legs*
- calculate lateral sway stiffness accounting for axial loads and end restraints*
- calculate natural periods and dynamic amplification factors*
- calculate dynamic response with Euler amplification & P-delta effect*
- calculate secondary bending moments and increased axial leg loads*
- calculate axial and bending stresses in the legs at the lower guides*
- calculate factors of safety against overturning accounting for dynamic sway*
- calculate maximum vertical pad reactions on sea bed*
- calculate maximum unity stress checks in legs*

As an integral part of the analysis procedure an effective length factor becomes established. Although this may vary from location to location, for the maximum stress design check this factor should not be less than 2.0 (see Section 3.3).

It would be useful to characterize typical magnitudes of each of the contributions from the above list to the total stress at the critical location in the leg (the lower guide). This can only be done in very general terms. For the generic liftboat, as originally specified, (Table 1.1) with the original design environmental conditions (Table 2.1) the following numbers are indicative of the relative importance of some of the terms. The **base value** is the maximum leg bending moment, with the bottom of the leg pinned, with the guides correctly modeled, without dynamics and without the P-delta effect. The effective length for this condition is 2.16.

- dynamics increases the base value by 6.7%*
- P-delta (inc. Euler) increases the dynamics value by 41.1%*

with soil stiffness so $K = 2.0$, base value is reduced by 10.1%

dynamics increases new base value by 5.3%

P-delta (inc. Euler) increases new dynamics value by 36.9%

For an improved liftboat design (see Section 6) the same relative values are:

dynamics increases the base value by 5.3%

P-delta (inc. Euler) increases the dynamics value by 37.8%

with soil stiffness so $K = 2.0$, base value is reduced by 10.5%

dynamics increases new base value by 4.2%

P-delta (inc Euler) increases new dynamics value by 35.1%

The relative importance of different terms on bending moments, and induced bending stresses, can be seen in general terms from the above examples. Allowable stresses and unity checks are affected in a slightly more complicated manner, but follow the same general trend.

Another way of looking at the general importance of dynamics, end fixity, and the P-delta effect is to consider the change in overturning safety factor (O/T SF) as the terms are varied. The improved design liftboat in the next section has an uncorrected O/T SF in the original design environmental conditions (Table 2.1) of 1.36. The uncorrected O/T SF is calculated by dividing the minimum stabilizing moment by the maximum overturning moment from environmental forces, without considering hull deflections. The minimum stabilizing moment is the product of the platform total weight (minus buoyancy) multiplied by the minimum horizontal distance from the center of gravity to the line joining a pair of legs. The corrected O/T SF is found from the same stabilizing moment but an overturning moment increased by the sway of the platform center of gravity. See pages 19 and 20 of Appendix 4 for further explanation of these terms. The following values are obtained for the corrected factor of safety:

K = 2.0, no dynamics	FS = 1.19
K = 2.0, w/dynamics	FS = 1.15
K = 2.16, no dynamics	FS = 1.17
K = 2.16, w/dynamics	FS = 1.12

Dynamics are reducing the overturning safety factor by just over 4%.

The change in the effective length factor changes the O/T SF by about 2.5%

The P-delta effect changes the O/T SF by the range 15% to 23% in this example.

Clearly, the relative importance of the contributing terms is different for their effect on bending stresses and for their effect on overturning safety factors. However the P-delta effect has the largest influence in this case as in the example for bending stresses. In this case, dynamics is twice as influential as changing the bottom fixity, whereas bottom fixity was seen to have more effect than dynamics on leg stresses.

The conclusion from this comparison of terms is that no term should be neglected, or assumed to be dominant in all situations. Refer also to Section 3.4, where the influence of the "eccentricity" of the rack and pinions is discussed.

5.1 Leg Stress Checks Required

In the Interim Report (Reference 1) the stress checks to be performed on liftboat legs were described in some detail in Appendix IV. Essentially the checks are on the combined axial compression and bending stresses. According to ABS Rules, which follow the AISC stress convention (Reference 9), allowable axial stresses, F_a , are computed which are to be the least of:

- a) *yield stress divided by appropriate factor of safety*
- b) *overall buckling stress divided by appropriate factor of safety*
- c) *local buckling stress divided by appropriate factor of safety*

The appropriate factors of safety for a) and c) are generally 1.25, as they represent combined (live) loadings. The factor of safety for b) is either 1.25 or 1.44, depending on the slenderness ratio, the yield stress, etc. The overall buckling stress is well-defined in Reference 3, although the local buckling stress must be found from another source. API RP 2A is used (Reference 6) to find elastic and inelastic local buckling stresses.

Note that the latest revision of the ABS unity check requirements is contained in Notice No. 1, effective May 1989, applicable to the 1988 MODU Rules (Reference 3). In this version a coefficient C_m is introduced when f_a/F_a exceeds 0.15, bringing the stress check more closely in line with AISC and API similar unity stress checks (References 9 and 6).

When f_a/F_a is less than or equal to 0.15, the required ABS unity stress check is:

$$f_a/F_a + f_b/F_b \leq 1.0$$

When f_a/F_a is greater than 0.15, the required ABS unity stress check is:

$$f_a/F_a + C_m f_b / ((1 - f_a/F'_e) F_b) \leq 1.0$$

Where:

- f_a = actual axial stress
- F_a = allowable axial stress
- f_b = actual bending stress
- F_b = allowable bending stress
- F'_e = $12\pi^2 E / (23(Kl/r)^2)$
- F_e = ABS/AISC-defined Euler buckling stress and may be increased under ABS rules by 1/3 for combined (static and environmental) loadings.

K = effective length factor.
 C_m = coefficient which relates to joint translational freedoms. For liftboats this coefficient is to be taken as 0.85.

The AISC allowable stress design rules (Reference 9) (and most derivatives) were written with structural steel buildings in mind, with relatively stiff frames. The modification to the simpler unity check (when f_a/F_a exceeds 0.15, first introduced by ABS in their 1988 rules) is designed to take better account of secondary bending stresses in frames subject to sidesway. However, this stress check should normally be applied to first order stresses which are calculated from a linear analysis. When stresses are rigorously calculated to include secondary bending effects (caused by the P-delta effect) this stress check may be overly conservative. Furthermore, because the sidesway of liftboats is generally much larger than the sidesway of normal building frames, the AISC stress check may give unpredictable results.

A rational formula for use in stress checks where the stresses have been calculated correctly accounting for the second order stresses induced by large sway deflections is used by DnV (References 4 and 5). This formula is usually stated by DnV in the form of a Usage Factor, η , which should not exceed 0.8 for storm load conditions, in the intact condition. A value of unity for η is used to evaluate structural integrity in a damaged condition.

$$\eta = f_a/f_{cr} + (f_b + f_{b0})/((1 - P/P_E)f_{cr})$$

Where:

f_{cr} = local critical stress (see below)
 f_{b0} = second order stress induced by P-delta effect
 P = average axial load on leg
 P_E = Euler buckling load, as defined below.
 f_{cr} = ((leg total axial stress)(yield stress))/(leg von Mises stress)
 P_E = $\pi^2 EI/(Kl)^2$

Where:

K = effective length factor
 l = leg length extended.

The same type of formula can be derived by a combination of the AISC plastic design formula N4-2 on page 5-95 of Reference 9, and the "normal" unity check adopted by the ABS (which is represented by formulae H1-1, H1-2, and H1-3 in Reference 9).

Expressing the DnV formula as a unity check yields:

$$1.25 f_a/f_{cr} + 1.25 (f_b + f_{b0})/((1 - P/P_E)f_{cr}) \leq 1.0$$

Comparisons of the three unity checks (ABS pre-1988, ABS post-1988 and DnV) indicate that there is not a consistent relationship between them. Unity checks for a range of effective leg lengths from 1.3 to 2.0 were investigated for a range of loading conditions. For the conditions investigated the DnV stress check varied between 0.58 to 1.22 (stresses included secondary bending effects). Applying the ABS post-1988 unity check to stresses calculated for the non-deflected (no P-delta effect) conditions resulted in differences of +/- 16% with the rational stress check results. Comparing the pre-1988 ABS unity check with the rational stress check (using stresses calculated correctly including the P-delta effect) showed a closer comparison, with the pre-1988 ABS unity check varying from +17% to 0% in excess of the rational stress check. **Consequently it is recommended that the rational stress check is adopted for liftboats,** although it is probably safe to use the pre-1988 ABS stress check as an alternative.

Figure 9 shows the standard unity stress check results automatically performed for each run of the computer program for liftboat elevated analysis described in Appendix 4. The program is configured to calculate all three unity checks described above. On the results summary tables the rational stress check is reported, as this is the recommended check to be used. In Figure 9 it is seen that, for the particular case in question, the pre-1988 ABS unity check is 12% higher than the rational stress check for legs 1 and 3. The post-1988 ABS unity check is 34% higher in this case (as it is applied to the stresses calculated with inclusion of secondary bending). The stress check results are further described on page 25 of Appendix 4.

As noted in Section 3.3, stresses at the bottom of the legs may be high under some situations, and fatigue damage may occur at the leg and pad connection. Initially, a through-thickness fatigue crack would permit the leg to flood with water. On re-floating the vessel, the water in the flooded leg may not drain as quickly as the leg is raised. This may lead to a complete loss of afloat stability and capsize, if the problem is not quickly recognized.

6.0 LIFTBOAT DESIGN TO SATISFY TARGET DESIGN CRITERIA

The original generic liftboat failed to meet the minimum necessary safety factors in the target design environmental conditions. In Reference 2 an improved design was described, with increased leg wall thickness. Improvements have now been taken further such that the new generic liftboat can safely withstand the target design environment with a minimum factor of safety of 1.15 against overturning, 1.1 against exceeding preload, and with a maximum leg unity stress check not exceeding 0.82. The same design with flooded legs has an overturning factor of safety of 1.3 and a unity stress check not exceeding 0.89.

Table 6.1, below, shows the principal characteristics of the new design and compares them to the ORIGINAL generic design.

TABLE 6.1

VARIABLE	Original	New
LOA	90.0 ft	90.0 ft
Maximum Beam	42.0 ft	42.0 ft
Depth	8.0 ft	9.0 ft
Draft (approximate)	3.5 ft	4.5 ft
Distance between forward leg centers	50.0 ft	50.0 ft
Distance from fwd. leg centers to aft leg center	66.0 ft	66.0 ft
LCG (fwd. of stern leg center when elevated in storm)	40.0 ft	44.0 ft
TCG (on vessel centerline)	0.0 ft	0.0 ft
Displacement (max)	650.0 kips	850.0 kips
Lightship weight	525.0 kips	725.0 kips
Leg Length	130.0 ft	130.0 ft
Leg Diameter (O.D.)	42.0 in	42.0 in
Leg Wall Thickness	0.5 in	0.875 in
Yield strength of steel in legs	50.0 ksi	60.0 ksi

In creating the new design to satisfy design criteria for elevated operations, an attempt has been made to keep to the original geometry. Significant further improvements could be made by changing the leg spacing, making the forward legs further apart. Additionally the same single rack arrangement has been maintained, keeping the rack costs similar, but not offering the significant structural advantages of a double rack.

Although afloat stability has been considered, its treatment is beyond the scope of this report. It should however be noted that a lower lightship weight may be attained, and that the maximum displacement may possibly be increased.

Another point that has not been addressed is leg stresses in the afloat condition. ABS Rules (Reference 3) require a 6 degree single amplitude roll or pitch at the natural period of the unit plus 120% of the gravity moment caused by the angle of inclination of the legs for a transit condition for MODUs. For a severe storm transit condition, wind moments corresponding to 100 knot wind speed, with 15 degrees roll or pitch at a 10 seconds period, plus 120% gravity moment are required if detailed calculations or model tests have not been performed. Liftboats for restricted service probably come somewhere in the middle of this. It seems likely that 6 degrees roll amplitude will be exceeded at the natural period in severe weather. However it may be unreasonable for limited service conditions to expect the afloat stability capability to resist 100 knot wind conditions. It is again emphasized that the maximum induced leg stresses may be tolerable in the selected target environment for afloat conditions, **but the fatigue damage done in a few storms may cause leg failure (or jacking tower and bracing cracking) unless proper fatigue consideration has been given to the vessel design in the afloat condition.**

Figures 10 through 13 show the analysis results in tabular form, output directly from the program described in Appendix 4. Wave-wind-current forces have been evaluated, together with static and dynamic response, from five directions. Graphs showing vertical footing reactions are shown in Figures 15 through 19.

From Figure 10, it is seen that the maximum vertical pad reaction is 401 kips for the critical direction for evaluating preload requirement (110.75 degrees). The total weight considered in the analysis is 800 kips. This is selected as the maximum load to be allowed in storm conditions. Using a preload safety factor of 1.1, a preload pad reaction of 441 kips must be achieved. With the center of gravity at the geometric leg center, the total vessel weight at maximum preload must be $3 \times 441 = 1323$ kips. This is 523 kips in excess of the total weight for the analysis and would require 523 kips of preload to be pumped on board and then dumped before elevating to the operating air gap.

Note that an air gap of 17 feet has been selected for the storm conditions analyzed. If operations are to take place at a much larger air gap, part of the normal storm preparations should be to change to the storm survival air gap (of 17 feet in this case). Note also that a rather shallow pad penetration of 3 feet has been used, as originally directed by the Statement of Work for this project, commensurate with a sandy sea bed, or firm clay. Deeper pad penetrations may dictate a reduction in water depth capacity for this new design.

Figure 15 shows the variation of vertical pad reactions as the wave passes by. The difference between the uncorrected (labeled "STAT") and the corrected (labeled "DYN") values is partly caused by the P-delta effect and partly caused by dynamic response (see Section 5 for further explanation).

The lowest pad vertical reactions are seen in Figures 11 and 16, where the critical loading direction (69.25 degrees) for overturning is investigated. The reported corrected safety factor against overturning (see Figure 11) is 1.16. This is the minimum overturning safety factor for any direction. The minimum vertical footing load goes to just 25 kips under these conditions.

Of the other directions checked (beam, or 90 degrees, head and stern directions) the maximum unity checks are found with the environment coming from the beam direction. Unity checks for the forward legs are a maximum of 0.78, with the stern leg 0.82. The unity checks for the forward legs are a maximum of 0.81 for the limiting preload direction of 110.75 degrees.

The yield stress of the leg steel is 60 ksi and the leg wall thickness is 0.875 inches. The design could be further improved, either making the vessel less costly, without exceeding a 1.1 overturning safety factor and 1.0 for the unity stress checks in the legs, or alternatively the water depth capability could be further extended.

Figure 7 shows results for the same vessel with flooded legs and may be compared to Figure 10. A small increase in the maximum unity stress check (from 0.80 to 0.87, or 9%) is compensated for by the increase in the overturning safety factor (from 1.15 to 1.32, or 15%) when the legs are designed to be free flooding. The vertical pad reactions are increased, but the same increase is available at preload time. Deliberately designing liftboats to have free-flooding legs (as do many jack-up drilling rigs) improves elevated factors of safety against overturning, but may reduce reserve stability during leg raising and lowering. However in the normal transit condition, with the legs fully raised, free-flooding legs have the same characteristics as buoyant legs, with the advantage that they cannot be inadvertently raised partly full. Additional corrosion protection would be required inside the legs.

An important part of safe operations for this new design, as for any liftboat, would be clear instructions in the Operations Manual regarding preloading and arrangement of ballast and variable loads when elevated, as well as when floating. The final design should have at least the same reserve afloat stability as other similar vessels, but to properly address this is beyond the scope of this report.

7.0 SUMMARY AND CONCLUSIONS

1. A simplified analysis of liftboat leg strength has been compared to a more detailed finite element analysis (see Appendix 5). The simplified analysis, where it is assumed that horizontal reactions are shared equally by all three legs, gives comparable results and is considered adequate for design purposes. The method has been programmed on a personal computer (see Appendix 4) and is particularly suitable for analyzing parametric variations.
2. The ABS shallow water wave theory (Reference 3) has been compared to cnoidal, solitary, Airy, and Stokes' 3rd order wave theories. In shallow water depths where wave height and period values would generally be regarded as being best described by cnoidal wave theory, the ABS method produces loading results which compare closely to those produced using cnoidal theory. Solitary wave theory is a limiting case of cnoidal theory, characterized by a wave height only, without an associated period. In deeper waters where the wave height and period values would be best described using Stokes' 3rd or higher order theories, the ABS method produces loading results that compare closely to those produced using Stokes' 3rd order wave theory. In deep water small amplitude wave conditions, the ABS method produces loading results that converge towards those produced using linear Airy wave theory. Full details of this extensive comparison are contained in Appendix 1 of The Interim Report (Reference 1) where it is shown that the ABS method produces force results that consistently agree most closely with the results produced by the discrete wave theory which is most appropriate for the conditions studied. Inappropriate theories are shown to produce results that can be in a range of from less than half to more than twice the correct values. It is concluded that the ABS wave loading method is a satisfactory wave loading method for liftboats, provided that current is also included.
3. The effective leg length, or K-factor, is determined from the top and bottom leg fixity conditions (see Section 3.3, Appendix 3 and Appendix 4). The K-factor for a particular condition, for a particular liftboat, is not an input to the analysis, but results from the analysis and is needed for the checking of allowable stresses (see Section 5.1 and Appendix 4). K-factors with different end restraints are summarized in Table 7.1 on the next page. An approximate solution that may be used in preliminary design is to treat the bottom of the legs as pinned and the top as fixed, using a K-factor of 2.0 in order to find the lateral sway response. However the situation is really more complicated than this, as Table 7.1 illustrates.

Table 7.1 K-Factors With Different End Restraints

Extreme Storm Conditions	Pinned bottom	Pad & soil* at bottom
Real top w/upper & lower guides	2.2	2.0
Fully fixed top	2.0	1.8
Mild Weather Conditions	Pinned bottom	Pad & soil* at bottom
Real top w/upper & lower guides	2.2	1.6
Fully fixed top	2.0	1.4

* denotes typical soil conditions for design.

In order to achieve a safe design in the softest soil conditions, a K-factor of 2.0 is to be used. In fact, if the soil was of uniform strength beneath the pads, a value of 1.9 would rarely, if ever, be exceeded for typical liftboats, as explained in Appendix 6 (also see Reference 8). However, because liftboats frequently elevate on uneven sea beds, and may inadvertently place one or more pads on a hard object on the sea bed, there must be some allowance for eccentric loading of the pads. Such eccentric loading may increase the maximum stresses throughout the leg including those in the area of the lower guide. Hence the K-factor for design is set at a minimum of 2.0, providing for a nominal amount of sea bed rotational stiffness, and allowing for other factors such as fabrication imperfections, in-service damage, corrosion, and other unknown factors.

4. In order to correctly determine leg stresses in final design, or in a regulatory approval process, the analysis procedure must treat the leg fixity conditions correctly at the top and at the bottom. If this is not done incorrect guide reactions and bending moments will result. The top of the legs are not rigidly fixed to the liftboat hull but are restrained by horizontal guides, with vertical load transfer through racks and pinions (see Sections 3.0, 3.3, Appendix 4, Appendix 5, and Appendix 6). The structural modelling of the leg connection to the hull should reflect these fixity conditions. If the bottom of the leg is treated as pin-jointed an effective length factor of around 2.2 will result for typical upper leg fixity conditions (see Appendix 6). In realistic analysis of liftboats an allowance must also be made for lack of perfect fit of the legs in the guides, for lack of perfect straightness of the legs, and for the inability of the liftboat operator to perfectly level the hull. To account for these items the hull should be assumed to be deflected by an amount equal to not less than 0.3% of the average leg length extended beneath the hull (Reference 5). By virtue of the P-delta effect this will increase leg bending stresses and sea bed reaction forces for the heaviest loaded legs.
5. In Reference 1 it is shown that the generic liftboat, with maximum variable load, has a natural sway period of 3.0 seconds when elevated at a 20 foot air gap, with 8 feet of leg penetration in 40 feet of water (and a K-factor of

2.0, representing storm conditions). The ABS MODU Rules (Reference 3) contain safety factors to be used in stress checks which are intended to account for dynamic response where this is significant. Dynamic amplification will cause bending stress increases beginning at around 5% when the sway period exceeds three seconds. Dynamic analysis should be used under such circumstances. Provided that all important effects, as well as dynamics (see Section 5.0) are included in the analysis, these safety factors are adequate for the design and analysis of liftboats.

6. Design storm conditions for (elevated) vessels approved for restricted service are recommended to be a minimum wind speed of 70 knots, and a uniform current speed of 1.7 knots (see Section 2.0). The minimum wave height and period should correspond to a 1-year return period storm wave. In the Gulf of Mexico, wave height and period can be linked to maximum operating water depth in accordance with industry practice. The logic for this is described in Reference 7, where wave heights are given for a range of water depths and return periods. All forces are to be considered co-linear.

For vessels approved for unrestricted service, the design wind speed should be 100 knots, together with a uniform current of 2.5 knots (see Section 2.0). Wave height and period (also linked to maximum operating water depth) should correspond to a 100-year return period storm wave. Table 7.2, below, gives guidance on minimum wave heights to be used.

Table 7.2 Wave Heights and Water Depths For Liftboat Design

Water Depth for Design	Restricted	Unrestricted
0 feet to 10 feet	5 feet	8 feet
10 feet to 20 feet	7 feet	90% of water depth
20 feet to 30 feet	10 feet	90% of water depth
30 feet to 40 feet	12 feet	90% of water depth
40 feet to 50 feet	15 feet	90% of water depth
50 feet to 75 feet	18 feet	$45 + (WD - 50) * 2/5$ feet
75 to 100 feet	20 feet	$45 + (WD - 50) * 2/5$ feet
100 to 125 feet	23 feet	72 feet
125 to 150 feet	26 feet	74 feet
150 to 200 feet	30 feet	75 feet

In the above table WD represents water depth in feet.

Wave periods for design should also be related to water depth. Generally shorter wave periods will cause greater response because of dynamic amplification, while longer wave periods may cause greater response as they may have more energy in shallow water. Therefore a range of periods should always be investigated. Table 7.3, gives guidance as to minimum periods to be analyzed.

Table 7.3 Wave Periods and Water Depths For Liftboat Design

Water Depth for Design	Restricted	Unrestricted
0 feet to 10 feet	3.5 sec	4 sec
10 feet to 20 feet	4 sec	4 + (WD - 10)*3/20 sec
20 feet to 30 feet	4.5 sec	4 + (WD - 10)*3/20 sec
30 feet to 40 feet	5 sec	4 + (WD - 10)*3/20 sec
40 feet to 50 feet	5.5 sec	4 + (WD - 10)*3/20 sec
50 feet to 75 feet	6 sec	11 sec
75 to 100 feet	6.5 sec	12 sec
100 to 125 feet	7 sec	12.5 sec
125 to 150 feet	7.5 sec	13 sec
150 to 200 feet	8 sec	13 sec

7. Three basic checks should be performed for any new design (see Section 2.0 and References 3, 4, and 5). These checks should ensure the following conditions are met at the maximum design water depth, for a specified air gap and pad penetration, as well as for a specified maximum variable load:
 1. *The minimum factor of safety against overturning should be 1.1, and sway response should be accounted for when calculating this term.*
 2. *The maximum vertical pad reaction achieved during preloading should be at least 1.1 times the maximum pad reaction that may be experienced in the design storm conditions.*
 3. *The maximum leg stresses should not result in a rational unity check in excess of 1.0.*

If the liftboat is to be operated in a location where larger pad penetration will occur than was considered by the designer (or for the conditions that were given regulatory approval) the permissible water depth and/or the

permissible air gap should be reduced proportionately. Similarly, operations requiring excessive air gap must also be subject to reduced water depth and/or pad penetration.

In locations close to the limiting water depth for a particular liftboat, where a small variable load condition may exist during elevated operations, overturning stability may be the principal limitation on safe operability. ***This overturning limitation is seen in Reference 2 to become limiting for the generic liftboat as the K-factor is decreased below 1.85. This is also the limiting factor for the redesigned boat described in Section 6.*** Consideration should be given to carrying additional ballast water in the hull in such circumstances, providing conditions 2 and 3, above are still met.

For safe operation, liftboats must be preloaded so that they can meet the second condition above, in a 1-year return period storm, on every location, prior to elevating to operating air gap. In calculating the minimum necessary preload for the location, account must be taken of the full range of variable loads to be carried when elevated, the final elevated air gap, the water depth, and the depth of penetration of the pads.

8. There is no doubt that liftboats can be built to meet the above conditions, as evidenced by the modified design for the generic liftboat presented in this report (Section 6.0).
9. Other fundamental design checks needed for liftboat design and regulatory approval but not addressed in this report include:
 - *static stress and fatigue analysis, of the leg-pad connection*
 - *dynamic stress analysis of the legs in transit conditions*
 - *rigorous intact floating stability analysis for all leg positions*
 - *stability analysis with one leg flooded, for all leg positions.*

8.0 REFERENCES

1. Stewart Technology Associates, Liftboat Leg Strength Structural Analysis, Interim Report, February, 1990, prepared for US Coast Guard, Research and Development Center, Groton, CT.
2. Stewart Technology Associates, Liftboat Leg Strength Structural Analysis, Variation of K-Factors and Variation of Leg Diameter/Wall Thickness, April, 1990, prepared for US Coast Guard, Research and Development Center, Groton, CT.
3. American Bureau of Shipping, Rules for Building and Classing Mobile Offshore Drilling Units, 1988. Available from ABS, P. O. Box 910, Paramus, New Jersey 07653-0910.
4. Det norske Veritas, Rules for Classification of Mobile Offshore Units, Part 3, 1985/1986. Available from DnV Veritas Vein 1, 1322 Hovik, Norway.
5. Det norske Veritas, Classification Note No. 3145, Strength Analysis of Main Structures of Self-Elevating Units, May, 1984. Available from DnV Veritas Vein 1, 1322 Hovik, Norway.
6. American Petroleum Institute, Recommended Practice For Planning, Designing and Constructing Fixed Offshore Platforms, 19th Edition, August, 1991. Available from API, 1220 L Street NW, Washington, DC 20005
7. Stewart, W.P., Liftboat Elevated Structural Analysis, Paper presented to SNAME Texas Section Meeting, August 16, 1990.
8. Stewart, W.P., et al, Observed Storm Stability of Jackup Boats (Liftboats), Proceedings of 23rd Annual Offshore Technology Conference, May, 1991, Houston, TX.
9. American Institute of Steel Construction, Manual of Steel Construction, Allowable Stress Design, Ninth Edition, 1989. Available from AISC, 1 East Wacker Drive, Suite 3100, Chicago, Illinois, 60601.

LIFTBOAT GEOMETRY AND DESIGN CALCULATIONS

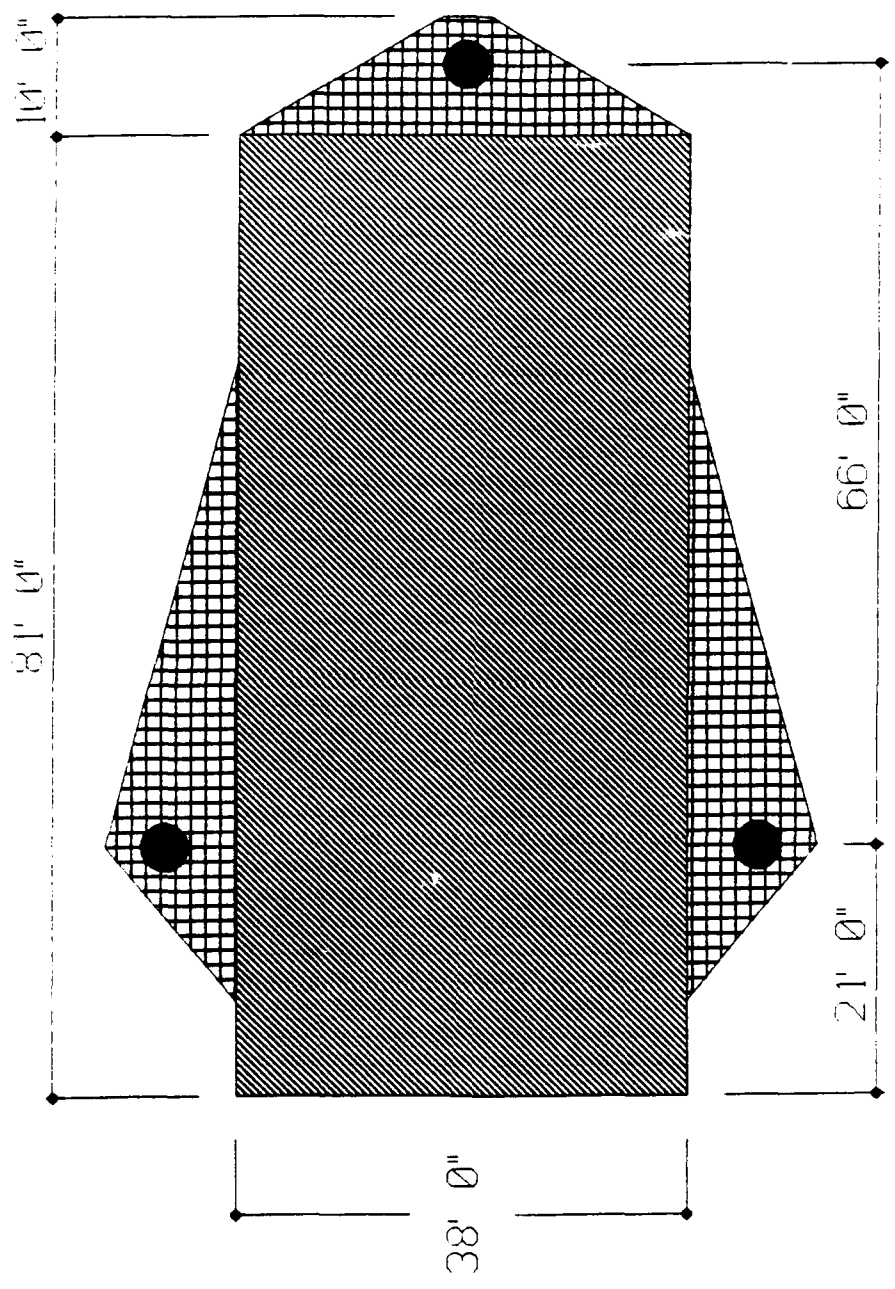

GENERIC LIFTBOAT - PLAN VIEW
STEWART TECHNOLOGY ASSOCIATES
October 31, 1989 | FIGURE 1

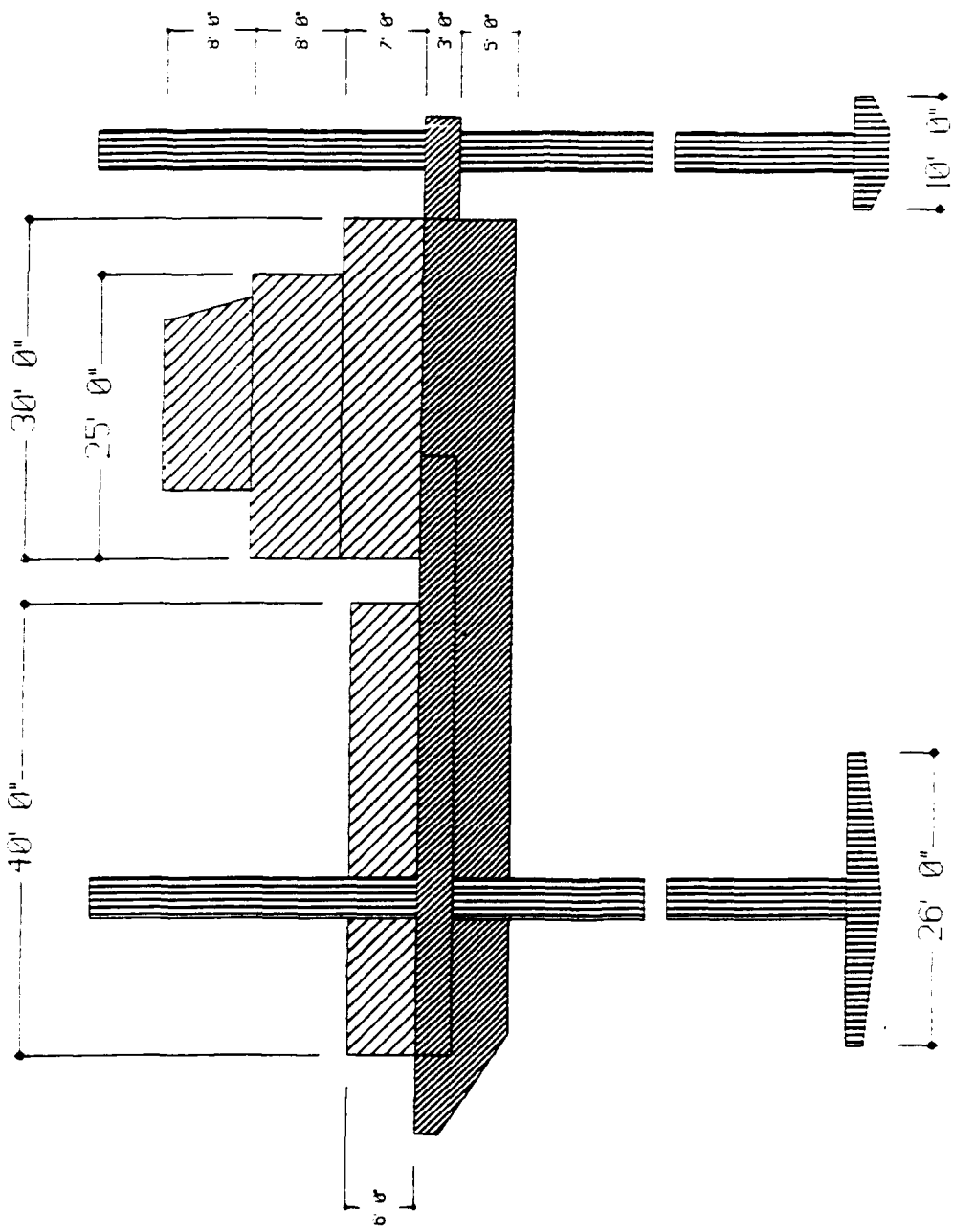

GENERIC LIFTBOAT - STIFF ELEVATION
 STEWART TECHNOLOGY ASSOCIATES
 October 31, 1989 | FIGURE 2

Total leg length 130 feet

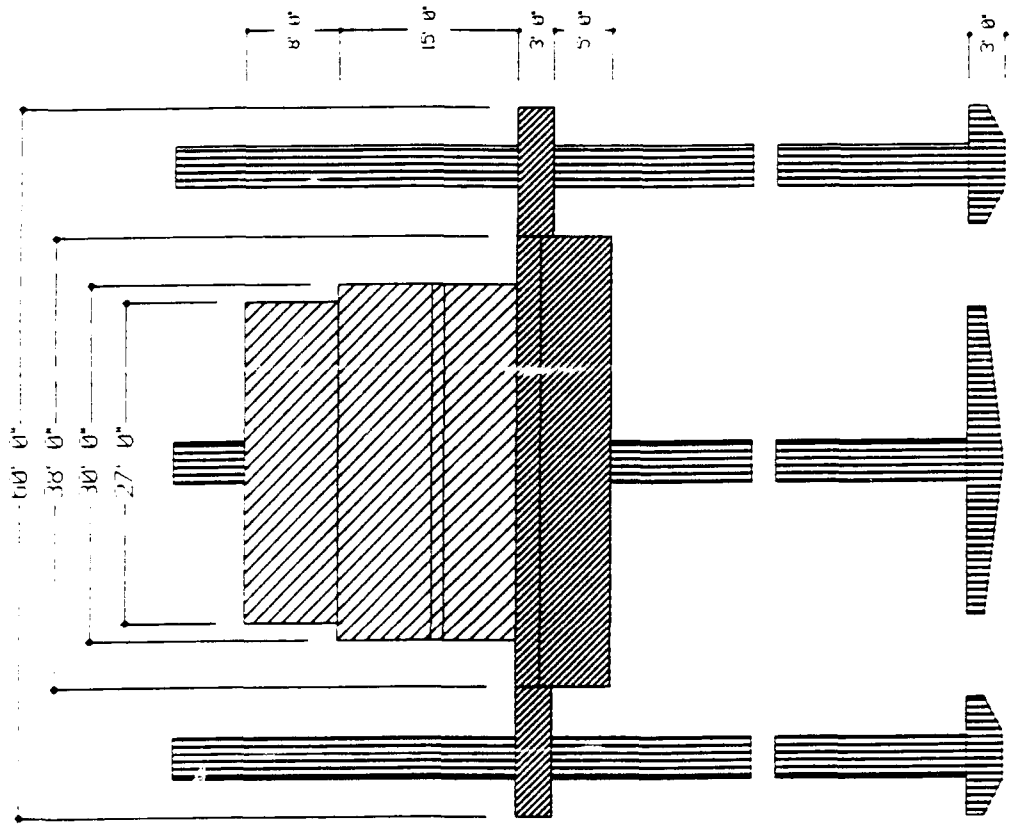

GENERIC LIFTBOAT - BOW ELEVATION

STEWART TECHNOLOGY ASSOCIATES

October 31, 1989

FIGURE 3

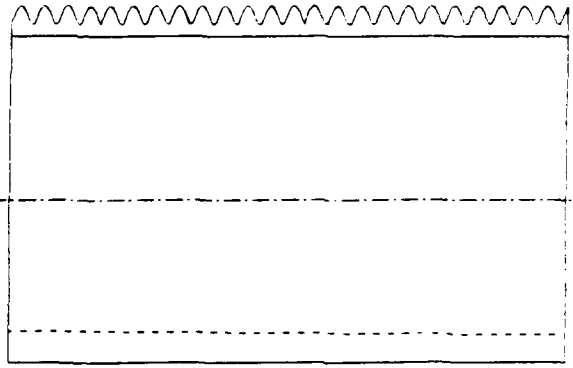
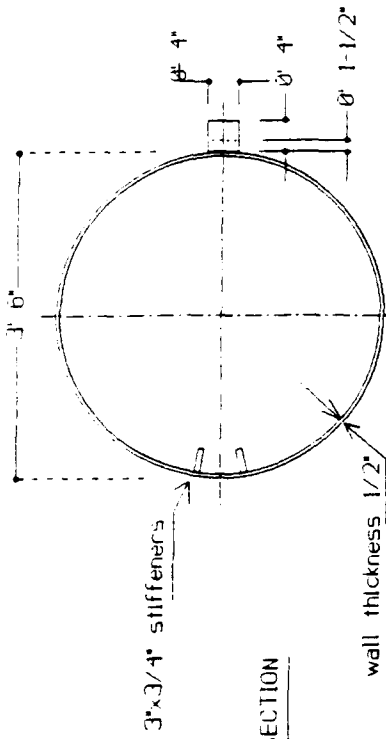

NOTES:

1. Steel is 50 ksi yield strength.
2. All legs have racks facing inboard.
3. Rack and stiffeners uniform throughout.

GENERIC LIFTBOAT LEG DETAIL	
STEWART TECHNOLOGY ASSOCIATES	
October 31, 1989	FIGURE 4

STA LIFTBOAT v1.01 December 1990		07/30/91 Date of this run	
!!!! THIS IS THE DATA INPUT & INTERMEDIATE PROCESSING FILE !!!!			
AFTER ALL DATA IS INPUT/CHANGED, PRESS ALT-A. RESULTS FILE WILL LOAD.			
PRINTING: Alt-P for input; Alt-W for wind.		Boat name: STA LIFT1	
Run Ref.:	65ft, 20/10/2 Limiting Preload, Flooded Legs		<<<appears on graphs
COPYRIGHT 1990 STEWART TECHNOLOGY ASSOCIATES			
This spreadsheet program uses the ABS 1985 Rules method for finding wave forces on a LIFTBOAT. The user is prompted for data, and for controls.			
Only data in shaded cells can be edited. Last data used is displayed.			
EDIT INPUT DATA		5 AvShield	110.75 1st wave angle (deg)
20 Input wave height (ft)	3.51	3.51	3.51 Leg diams 1,2,3 (ft)
10 Input wave period (sec)	2	2	2 Cm1, Cm2, Cm3
65 Input water depth (ft)	0.7	0.81	0.7 CD1, CD2, CD3
100 Lattice area (sqft)	30 lattice av.ht.		70 wind v2 (kn)
19 WH1 (ft)	30 WH2 (ft)	2 tide vel (kn)	0 wind v1 (kn)
90 WB (ft)	38 WL (ft)	6.32 LeverArm	800 Total weight (kips)
66 distance from aft to fwd legs (ft)			24 LCG (ft to foward legs)
50 distance bet. fwd. leg centers (ft)			0 TCG (+ve towards L1)
3 pad penetration	2 leg buoy. 1=dry 2=flood	0 init phase ang (deg)	
0 windforce kips	17 air gap (ft)	0 wind elev (ft)	
Wind force switch:	2 (1=input; 2=computed)	130 tot. leg length (ft)	

FIGURE 5: MAIN DATA INPUT SCREEN FOR LIFTBOAT ANALYSIS PROGRAM

STA LIFTBOAT v1.01 December 1990		07/30/91 Date of run	
FINAL PROCESSING FILE		Boat Name: STA LIFT1	
Run Ref.:	65ft, 20/10/2 Limiting Preload, Flooded Legs		<<<---- appears on graphs
Press Alt-S to save graphs, Alt-A for RESULTS SUMMARY, Alt-B for stress check			
Press Alt-I to print this input, Alt-R for results, Alt-C for stress checks, and Alt-T for transit motion stress checks.			
EDIT USER DEFINED VARIABLES		1.00 deflection multiplier	
4248000 Young's Modulus, leg steel (ksf)			2.00 K-equivalent
1.00 nat.period multiplier (norm.=1; no dyn.=.01)			501 Mult for pads
60.00 yield stress for leg steel			325 Max. calc. moment at pads
2 accept calc. w/ft (1=no, 2=yes)			1.00 add.mass coef.(norm.=1)
2 accept hull gyrad. (1=no, 2=yes)			5.00 VCG excluding legs (ft)
16.50 coef.on su to get soil G modulus			15.00 weight of 1 pad (kips)
225.00 su, soil und.shear str. (psf)			0.454 calculated leg kips/ft
14056 ks, calc.rot.stiff.soil (kip-ft/rad)			30.19 calculated hull gyrad.
8.00E+05 kj, rot.stiff.jack/hull (kip-ft/rad)			0.28 USER SPEC.leg kips/foot
20.40 k, calc.overall leg stiff.(kips/ft)			30.00 USER SPEC. gyrad. (ft)
0.003 Ke0, horiz.offset coef.			0.00 Beta, calculated
0.64 cylnder drag coef.(w/marine growth)			0.11 Mu, calculated
0.00 marine growth thickness (inches)			2.00 total damping (% crit.)
INPUT STRUCTURAL LEG DATA BELOW:			
3.00 VCG lower guide (ft)			1 geometry select.switch
42.00 leg OD (in)			14.00 d, guide spacing (ft)
0.875 wall thickness (in)			7.00 b, jack vcg (ft)
4.00 rack width (in)			4.50 h, jack support spacing (ft)
4.00 rack height to top teeth (in)			25.00 pad length (ft)
1.50 rack height to bot. teeth (in)			10.00 pad width (ft)
4.50 stiffener area in sqin			1.50 pad 1/2 height (ft)
0.04 leg wt.factor for appendages, etc			1 1 OR 2 RACK SWITCH
2ND Title for drag coefficient graph >>>>		LIFTBOAT 42 INCH DIAMETER LEG	

FIGURE 6: INTERMEDIATE DATE SCREEN FOR LIFTBOAT ANALYSIS PROGRAM

STA LIFTBOAT v1.01 December 1990

07/30/91 Date of this run

TABLE OF RESULTS

Run Ref.: 65ft, 20/10/2 Limiting Preload, Flooded Legs

STA LIFTBOAT v1.01 December 1990

Boat Name: STA LIFT1

INPUT SUMMARY

LIFTBOAT TYPE 1

STA RIG # # N

Wave height	20 feet	Tidal current	2 knots
Wave period	10 seconds	Wind driven curr.	0 knots
Water depth	65 feet	Pad penetration	3 feet
theta, wave dirn.	110.75 degrees	Air gap	17 feet
Wind force	COMPUTE BELOW	Wind speed	70 knots
Leg equiv.av.dia.	3.51 feet	Av. leg mass coef.	2 coef.
Damping ratio	2 % crit.	Av. leg drag coef.	0.74 coef.
Total weight	800 kips	Beta, top fixity	0.00 ratio
ks, soil stiff.	1.41E+04 kipft/rad	Mu, bottom fixity	0.11 ratio
su, soil und.ss.	225 psf	kj, JackHull stiff	8.00E+05 kipft/rad
Gfactor on su	16.5 coef.	Equiv. pad radius	8.92 feet
LCG	24 feet	TCG	0 feet
Ke0, Offset coef.	0.003 LegLength	VCG excldng. legs	5 feet
Fwd-aft leg dist	66 feet	Fwd leg spacing	50 feet
LegLength extend.	88 feet	Total leg length	130 feet

STA LIFTBOAT v1.01 December 1990

Legs are fully flooded

RESULTS SUMMARY

LIFTBOAT TYPE 1

STA RIG # # N

Pad1 bef.env.loads	255 kips	Pad2 bef.env.loads	291 kips
Pad3 bef.env.loads	255 kips	Weight - buoyancy	800 kips
Av.leg buoyancy	0 kips	Total buoyancy	0 kips
Lateral Stiffness	61 kips/ft	lateral x-stiff.	58 kips/ft
Wind force	37 kips	lateral y-stiff.	62 kips/ft
Max wav-cur.force	71 kips	Mean wav-cur.force	29 kips
Wind O/T moment	3604 ft-kips	Max. total force	109 kips
Amp.wav/cur.O/Tm	2192 ft-kips	Mean wav-cur.O/Tm	1490 ft-kips
Trsx sway period	4.02 seconds	Max.apparent O/Tm	7285 ft-kips
Tnyy sway period	3.91 seconds	Max torsion mom.	390 ft-kips
Nat. tor. period	3.49 seconds	DAF	1.18 ratio
Mean hull defn.	0.98 feet	Hull defn. amp.	0.57 feet
Max hull defn.*	1.62 feet	Offset+defn.**	1.88 feet
Uncorr.stab.mom.	11902 ft-kips	Euler leg load	1561 kips
Corr.stab.mom.	10365 ft-kips	Max. base shear	116 kips
Max.Up.guide reac.	218.0 kips	Max.low.gde.reac.	225 kips
Max.equiv.top load	98.90 kips	Max.horiz.SC.reac.	32.97 kips
BM.pad.max.w/o.PD.	325 ft-kips	BM.hull max.w/oPD.	2204 ft-kips
PDelta leg BM.max	847 ft-kips	BM.hull max. w.PD.	3052 ft-kips
PadMax.id.uncorr.	410 kips	PadMin.id.uncorr.	138 kips
PadMax.id.corrected	451 kips	PadMin.id.corrected	108 kips
Pad mean angle	0.7897 degrees	Pad max.angle	1.3263 degrees
Max.OT w/o PDelta	7682 ft-kips	Max.OT.mom.w.PD	9049 ft-kips
Max.hull ax.F1,F3	396.4 kips	Static offset **	3.17 inches
Max.hull ax.F2	305.0 kips	K-Equivalent	2.00 coef.
max fb, legs 1,3	27.83 ksi	Uncorr. O/T SF	1.63 ratio
max fb, top leg 2	31.46 ksi	Corrected O/T SF	1.32 ratio
max fa, legs 1,3	3.21 ksi	DnV O/T Safety F.	1.35 ratio
max fa, top leg 2	2.47 ksi	ABS pre-88 unity str.chk legs 1,3	0.95 ratio
Hull max.shr.str.	1.82 ksi	ABS pre-88 unity str.chk leg 2	0.94 ratio
fa/Fa ABS leg 2	0.28 ratio	Rational Unity str.chk.legs 1,3	0.85 ratio
fb/Fb ABS leg 2	0.66 ratio	Rational Unity str.chk.leg 2	0.87 ratio

FIGURE 7: STANDARD OUTPUT TABLE OF RESULTS FROM LIFTBOAT PROGRAM

P-Delta Effect

$$R1 = W/2 - W\delta/a - P\delta/a$$

$$R2 = W/2 + W\delta/a + P\delta/a$$

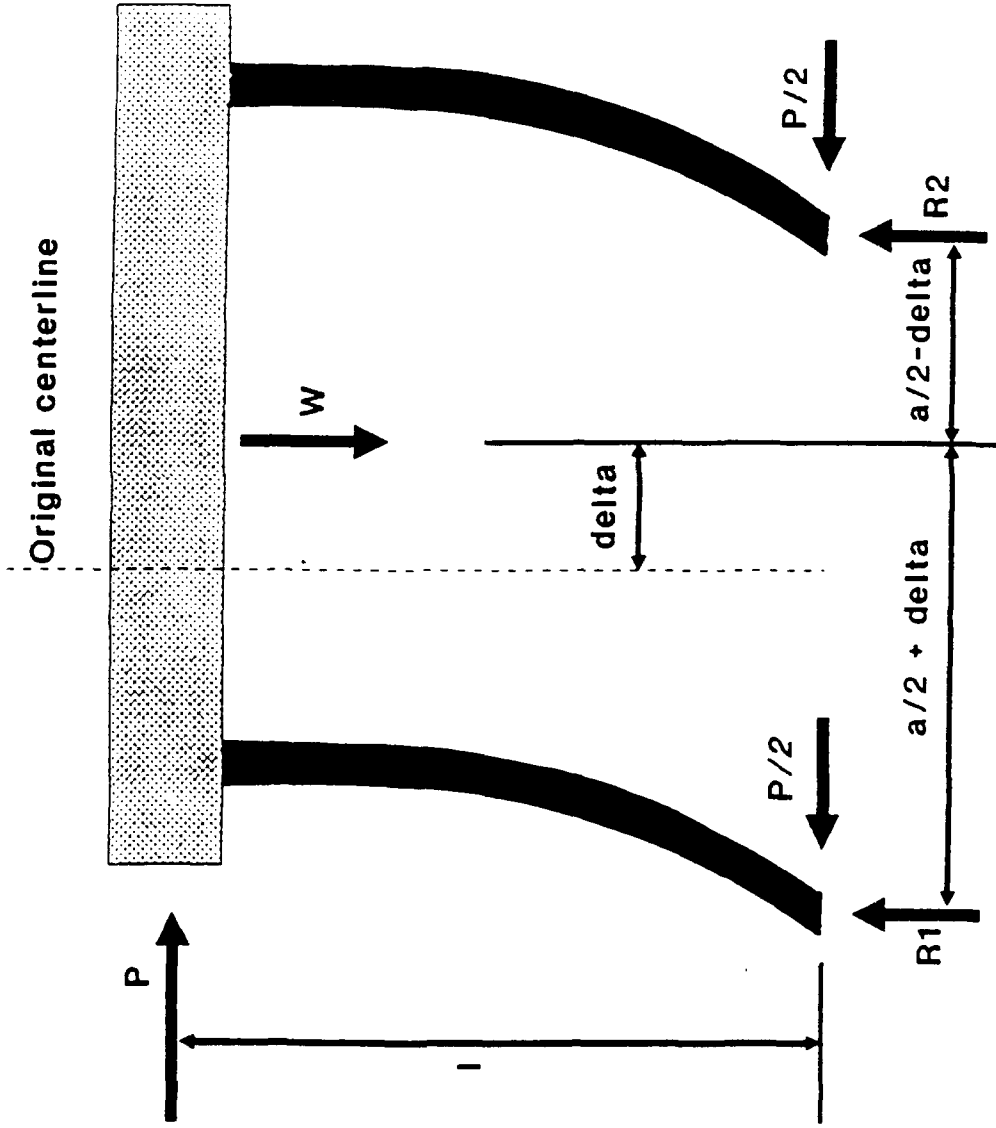

FIGURE 8

STA LIFTBOAT v1.01 December 1990

STRESS CHECK INTERMEDIATE RESULTS

07/30/91 Date of this run

Rig Name: STA LIFT1

Geometry Switch Selected - 1

Run Ref: 65ft, 20/10/2 Limiting Preload, Flooded Legs

Leg Area Moments of Inertia

Leg #	1 (port)	2 (stern)	3 (stbd)	Leg cross section area (sqin) ----->>>>	123.55
Ixx	1.1531	1.3582	1.1531	for-aft bending direction (ft4)	
Iyy	1.3582	1.1531	1.3582	lateral bending direction (ft4)	

Column Buckling Stresses

Legs are fully flooded

For definition of K-equivalent see manual

K = 2 for stress check

K-equiv

K-equiv	2.00		71.25 (F _{2y} /4PI ² E)(Kl/r) ²	71.25
Kl/r	151.82	(with K = 2)	12.63 PI ² E/(Kl/r) ²	12.63
Kl/r	151.82	(with K-equiv.)	42 leg diameter, D (in)	151.82
sqrt.fn.	98.51	[SQRT(2PIPIE/Fy)]	0.875 leg wall thickness, t	98.51
Fcr	12.63	ksi (critical overall buckling stress, ABS)		12.63
F.S.	1.44	(combined loads)	60 yield stress for leg (ksi)	1.44
D/t	47.00	ratio	(D/t).25= 2.62 (D/t to power .25)	47.00
E/9Fy	54.63	ratio	4248000 Young's modulus for leg (ksf)	54.63

Is D/t > E/9Fy? No, hence no local buckling check required by ABS.

Allowable Axial Compressive Stresses

K-equiv

0.12E/R	147.50	ksi (Younger)		147.50
2CE/D	368.75	ksi (F _{xe} , elastic local buckling str: API with C = 0.3)		368.75
Fxc	60.00	ksi (Inelastic local buckling stress: API)		60.00
Faa	48.00	ksi (ABS allowable axial stress 1), Para: 3.11.4)		48.00
Fab	8.77	ksi (ABS allowable axial stress 2), Para: 3.11.4)		8.77
Fac	48.00	ksi (ABS allowable axial stress 3), Para: 3.11.4)		48.00
Fa	8.77	ksi (min.val.of above 3; ABS allow. axial comp.str.)		8.77
Fb	48.00	ksi (ABS allowable comp.str.due to bending)		48.00
fa/Fa 1,3	0.37	<<<using K = 2	using K-equiv>>>	0.37
fb/Fb 1,3	0.58	<<<using K = 2	using K-equiv>>>	0.58
fa/Fa 2	0.28	<<<using K = 2	using K-equiv>>>	0.28
fb/Fb 2	0.66	<<<using K = 2	using K-equiv>>>	0.66

Is fa/Fa > 0.15? Yes, hence use 2nd ABS unity check.

Unity Checks at Lower Guide for Each Leg

1st ABS Unity Check				2nd ABS Unity Check			
K = 2	K-equiv.	0.85	Cm coefficient	K = 2	K-equiv.		
0.95	0.95		legs 1 and 3 (fwd legs)	1.14	1.14		
0.94	0.94		leg 2 (stern)	1.06	1.06		
8.79	8.79		ksi, F _e , ABS Euler str. * 4/3				

New Unity Check at "member ends" (lower guide) for combined and static loadings

0.65	combined; legs 1 and 3 (fwd legs)	0.09	static; legs 1 & 3
0.71	combined; leg 2 (stern)	0.07	static; leg 2

DnV Usage Factor Calculations

31.04	sigmax, axial stress legs 1, 3	59.69	sigmacr, critical stress legs 1, 3
33.93	sigmax, axial stress leg 2	59.74	sigmacr, critical stress leg 2
31.20	sigmae, von Mises equiv. legs 1, 2	0.85	DnV unity check Legs 1, 3
34.08	sigmae, von Mises equiv. leg 2	0.87	DnV unity check Leg 2

FIGURE 9: STANDARD STRESS CHECK OUTPUT FROM LIFTBOAT PROGRAM

STA LIFTBOAT v1.01 December 1990

07/30/91 Date of this run

TABLE OF RESULTS

Run Ref.: 65ft, 20/10/2 Limiting Preload, Dry Legs

STA LIFTBOAT v1.01 December 1990

Boat Name: STA LIFT1

INPUT SUMMARY

		LIFTBOAT TYPE 1	STA RIG #	# N
Wave height	20 feet	Tidal current	2	knots
Wave period	10 seconds	Wind driven curr.	0	knots
Water depth	65 feet	Pad penetration	3	feet
theta, wave dirn.	110.75 degrees	Air gap	17	feet
Wind force	COMPUTE BELOW	Wind speed	70	knots
Leg equiv.av.dia.	3.51 feet	Av. leg mass coef.	2	coef.
Damping ratio	2 % crit.	Av. leg drag coef.	0.74	coef.
Total weight	800 kips	Beta, top fixity	0.00	ratio
ks, soil stlff.	1.41E+04 kipt/rad	Mu, bottom fixity	0.11	ratio
su, soil und.ss.	225 psf	kj, JackHull stiff	8.00E+05	kipt/rad
Gfactor on su	16.5 coef.	Equiv. pad radius	8.92	feet
LCG	24 feet	TCG	0	feet
K _{e0} , Offset coef.	0.003 LegLength	VCG excludng. legs	5	feet
Fwd-aft leg dist	66 feet	Fwd leg spacing	50	feet
LegLength extend.	88 feet	Total leg length	130	feet

STA LIFTBOAT v1.01 December 1990

Legs are dry internally

RESULTS SUMMARY

		LIFTBOAT TYPE 1	STA RIG #	# N
Pad1 bef.env.loads	212 kips	Pad2 bef.env.loads	249	kips
Pad3 bef.env.loads	212 kips	Weight - buoyancy	674	kips
Av.leg buoyancy	42 kips	Total buoyancy	126	kips
Lateral Stiffness	61 kips/ft	lateral x-stiff.	58	kips/ft
Wind force	37 kips	lateral y-stiff.	62	kips/ft
Max wav-cur.force	71 kips	Mean wav-cur.force	29	kips
Wind O/T moment	3604 ft-kips	Max. total force	109	kips
Amp.wav/cur.O/Tm	2192 ft-kips	Mean wav-cur.O/Tm	1490	ft-kips
T _{rx} sway period	3.54 seconds	Max.apparent O/Tm	7285	ft-kips
T _{nyy} sway period	3.44 seconds	Max torsion mom.	390	ft-kips
Nat. tor. period	2.94 seconds	DAF	1.13	ratio
Mean hull defln.	0.98 feet	Hull defln. amp.	0.55	feet
Max hull defln.*	1.59 feet	Offset+defln.**	1.86	feet
Uncorr.stab.mom.	10023 ft-kips	Euler leg load	1561	kips
Corr.stab.mom.	8505 ft-kips	Max. base shear	114	kips
Max.Up.guide reac.	208.4 kips	Max.low.gde.reac.	215	kips
Max.equiv.top load	97.37 kips	Max.horiz.SC.reac.	32.46	kips
BM.pad.max.w/o.PD.	320 ft-kips	BM.hull max.w/oPD.	2174	ft-kips
PDelta leg BM.max	743 ft-kips	BM.hull max. w.PD.	2917	ft-kips
PadMax.Id.uncorr.	368 kips	PadMin.Id.uncorr.	96	kips
PadMax.Id.corrected	401 kips	PadMin.Id.corrected	72	kips
Pad mean angle	0.7897 degrees	Pad max.angle	1.3054	degrees
Max.OT w/o PDelta	7581 ft-kips	Max.OT.mom.w.PD	8706	ft-kips
Max.hull ax.F1,F3	388.4 kips	Static offset **	3.17	inches
Max.hull ax.F2	262.4 kips	K-Equivalent	2.00	coef.
max fb. legs 1,3	26.61 ksi	Uncorr. O/T SF	1.38	ratio
max fb. top leg 2	30.08 ksi	Corrected O/T SF	1.15	ratio
max fa. legs 1,3	3.14 ksi	DnV O/T Safety F.	1.12	ratio
max fa. top leg 2	2.12 ksi	ABS pre-88 unity str.chk legs 1,3	0.91	ratio
Hull max.shr.str.	1.74 ksi	ABS pre-88 unity str.chk leg 2	0.87	ratio
fa/Fa ABS legs 1,3	0.36 ratio	Rational Unity str.chk.legs 1,3	0.81	ratio
fb/Fb ABS legs 1,3	0.55 ratio	Rational Unity str.chk.leg 2	0.80	ratio

FIGURE 10: OUTPUT FOR NEW DESIGN - PRELOAD REQUIREMENT

STA LIFTBOAT v1.01 December 1990

07/30/91 Date of this run

TABLE OF RESULTS

Run Ref.: 65ft, 20/10/2 Limiting O/T SF, Dry Legs

STA LIFTBOAT v1.01 December 1990

Boat Name: STA LIFT1

INPUT SUMMARY

LIFTBOAT TYPE 1

STA RIG # # N

Wave height	20 feet	Tidal current	2 knots
Wave period	10 seconds	Wind driven curr.	0 knots
Water depth	65 feet	Pad penetration	3 feet
theta, wave dirn.	69.25 degrees	Air gap	17 feet
Wind force	COMPUTE BELOW	Wind speed	70 knots
Leg equiv.av.dia.	3.51 feet	Av. leg mass coef.	2 coef.
Damping ratio	2 % crit.	Av. leg drag coef.	0.74 coef.
Total weight	800 kips	Beta, top fixity	0.00 ratio
ks, soil stiff.	1.41E+04 kipft/rad	Mu, bottom fixity	0.11 ratio
su, soil und.ss.	225 psf	kj, JackHull stiff	8.00E+05 kipft/rad
Gfactor on su	16.5 coef.	Equiv. pad radius	8.92 feet
LCG	24 feet	TCG	0 feet
Ke0, Offset coef.	0.003 LegLength	VCG excludng. legs	5 feet
Fwd-aft leg dist	66 feet	Fwd leg spacing	50 feet
LegLength extend.	88 feet	Total leg length	130 feet

STA LIFTBOAT v1.01 December 1990

Legs are dry internally

RESULTS SUMMARY

LIFTBOAT TYPE 1

STA RIG # # N

Pad1 bef.env.loads	212 kips	Pad2 bef.env.loads	249 kips
Pad3 bef.env.loads	212 kips	Weight - buoyancy	674 kips
Av.leg buoyancy	42 kips	Total buoyancy	126 kips
Lateral Stiffness	61 kips/ft	lateral x-stiff.	58 kips/ft
Wind force	37 kips	lateral y-stiff.	62 kips/ft
Max wav-cur.force	71 kips	Mean wav-cur.force	29 kips
Wind O/T moment	3604 ft-kips	Max. total force	108 kips
Amp.wav/cur.O/Tm	2164 ft-kips	Mean wav-cur.O/Tm	1490 ft-kips
Tnxx sway period	3.54 seconds	Max.apparent O/Tm	7258 ft-kips
Tnyy sway period	3.44 seconds	Max torsion mom.	462 ft-kips
Nat. tor. period	2.94 seconds	DAF	1.13 ratio
Mean hull defln.	0.98 feet	Hull defln. amp.	0.54 feet
Max hull defln. *	1.58 feet	Offset+defln. **	1.85 feet
Uncorr.stab.mom.	10023 ft-kips	Euler leg load	1561 kips
Corr.stab.mom.	8511 ft-kips	Max. base shear	114 kips
Max.Up.guide reac.	201.2 kips	Max.low.gde.reac.	208 kips
Max.equiv.top load	96.97 kips	Max.horiz.SC.reac.	32.32 kips
BM.pad.max.w/o.PD.	319 ft-kips	BM.hull max.w/oPD.	2165 ft-kips
PDelta leg BM.max	652 ft-kips	BM.hull max. w.PD.	2817 ft-kips
PadMax.ld.uncorr.d.	329 kips	PadMin.ld.uncorr.d.	57 kips
PadMax.ld.corrected	353 kips	PadMin.ld.corrected	25 kips
Pad mean angle	0.7890 degrees	Pad max.angle	1.3003 degrees
Max.OT w/o PDelta	7550 ft-kips	Max.OT.mom.w.PD	8670 ft-kips
Max.hull ax.F1,F3	340.6 kips	Static offset **	3.17 inches
Max.hull ax.F2	320.1 kips	K-Equivalent	2.00 coef.
max fb, legs 1,3	25.70 ksi	Uncorr. O/T SF	1.38 ratio
max fb, top leg 2	29.04 ksi	Corrected O/T SF	1.16 ratio
max fa, legs 1,3	2.76 ksi	DnV O/T Safety F.	1.13 ratio
max fa, top leg 2	2.59 ksi	ABS pre-88 unity str.chk legs 1,3	0.85 ratio
Hull max.shr.str.	1.68 ksi	ABS pre-88 unity str.chk leg 2	0.90 ratio
fa/Fa ABS leg 2	0.30 ratio	Rational Unity str.chk.legs 1,3	0.75 ratio
fb/Fb ABS leg 2	0.61 ratio	Rational Unity str.chk.leg 2	0.82 ratio

FIGURE 11: OUTPUT FOR NEW DESIGN - O/T SAFETY FACTOR CHECK

STA LIFTBOAT v1.01 December 1990

07/30/91 Date of this run

TABLE OF RESULTS Run Ref.: 65ft, 20/10/2 Beam Loading, Dry Legs

STA LIFTBOAT v1.01 December 1990

Boat Name: STA LIFT1

INPUT SUMMARY

LIFTBOAT TYPE 1

STA RIG # # N

Wave height	20 feet
Wave period	10 seconds
Water depth	65 feet
theta, wave dirn.	90 degrees
Wind force	COMPUTE BELOW
Leg equiv.av.dia.	3.51 feet
Damping ratio	2 % crit.
Total weight	800 kips
ks, soil stiff.	1.41E+04 kipft/rad
su, soil und.ss.	225 psf
Gfactor on su	16.5 coef.
LCG	24 feet
Ke0, Offset coef.	0.003 LegLength
Fwd-aft leg dist	66 feet
LegLength extend.	88 feet

Tidal current	2 knots
Wind driven curr.	0 knots
Pad penetration	3 feet
Air gap	17 feet
Wind speed	70 knots
Av. leg mass coef.	2 coef.
Av. leg drag coef.	0.74 coef.
Beta, top fixity	0.00 ratio
Mu, bottom fixity	0.11 ratio
kj, JackHull stiff	8.00E+05 kipft/rad
Equiv. pad radius	8.92 feet
TCG	0 feet
VCG excldng. legs	5 feet
Fwd leg spacing	50 feet
Total leg length	130 feet

STA LIFTBOAT v1.01 December 1990

Legs are dry internally

RESULTS SUMMARY

LIFTBOAT TYPE 1

STA RIG # # N

Pad1 bef.env.loads	212 kips
Pad3 bef.env.loads	212 kips
Av.leg buoyancy	42 kips
Lateral Stiffness	62 kips/ft
Wind force	37 kips
Max wav-cur.force	73 kips
Wind O/T moment	3552 ft-kips
Amp.wav/cur.O/Tm	2246 ft-kips
Tnxx sway period	3.54 seconds
Tnyy sway period	3.44 seconds
Nat. tor. period	2.94 seconds
Mean hull defln.	0.96 feet
Max hull defln.*	1.59 feet
Uncorr.stab.mom.	10023 ft-kips
Corr.stab.mom.	8506 ft-kips
Max.Up.guide reac.	207.3 kips
Max.equiv.top load	97.87 kips
BM.pad.max.w/o.PD.	320 ft-kips
PDelta leg BM.max	721 ft-kips
PadMax.ld.uncorr.d.	358 kips
PadMax.ld.corrected	388 kips
Pad mean angle	0.7787 degrees
Max.OT w/o PDelta	7588 ft-kips
Max.hull ax.F1,F3	376.3 kips
Max.hull ax.F2	273.1 kips
max fb, legs 1,3	25.97 ksi
max fb, top leg 2	30.59 ksi
max fa, legs 1,3	3.05 ksi
max fa, top leg 2	2.21 ksi
Hull max.shr.str.	1.73 ksi
fa/Fa ABS leg 2	0.25 ratio
fb/Fb ABS leg 2	0.64 ratio

Pad2 bef.env.loads	249 kips
Weight - buoyancy	674 kips
Total buoyancy	126 kips
lateral x-stiff.	58 kips/ft
lateral y-stiff.	62 kips/ft
Mean wav-cur.force	29 kips
Max. total force	109 kips
Mean wav-cur.O/Tm	1490 ft-kips
Max.apparent O/Tm	7287 ft-kips
Max torsion mom.	413 ft-kips
DAF	1.13 ratio
Hull defln. amp.	0.56 feet
Offset+defln.**	1.85 feet
Euler leg load	1559 kips
Max. base shear	115 kips
Max.low.gde.reac.	214 kips
Max.horiz.SC.reac.	32.62 kips
BM.hull max.w/oPD.	2182 ft-kips
BM.hull max. w.PD.	2902 ft-kips
PadMin.ld.uncorr.d.	67 kips
PadMin.ld.corrected	36 kips
Pad max.angle	1.3049 degrees
Max.OT.mom.w.PD	8712 ft-kips
Static offset **	3.17 inches
K-Equivalent	2.00 coef.
Uncorr. O/T SF	1.38 ratio
Corrected O/T SF	1.15 ratio
DnV O/T Safety F.	1.12 ratio
ABS pre-88 unity str.chk legs 1,3	0.89 ratio
ABS pre-88 unity str.chk leg 2	0.89 ratio
Rational Unity str.chk.legs 1,3	0.78 ratio
Rational Unity str.chk.leg 2	0.82 ratio

FIGURE 12: OUTPUT FOR NEW DESIGN - BEAM LOADING STRESS CHECK

STA LIFTBOAT v1.01 December 1990

07/30/91 Date of this run

TABLE OF RESULTS

Run Ref.: 65ft, 20/10/2 Bow Loading, Dry Legs

STA LIFTBOAT v1.01 December 1990

Boat Name: STA LIFT1

INPUT SUMMARY

LIFTBOAT TYPE 1

STA RIG # # N

Wave height	20 feet	Tidal current	2 knots
Wave period	10 seconds	Wind driven curr.	0 knots
Water depth	65 feet	Pad penetration	3 feet
theta, wave dirn.	0 degrees	Air gap	17 feet
Wind force	COMPUTE BELOW	Wind speed	70 knots
Leg equiv.av.dia.	3.51 feet	Av. leg mass coef.	2 coef.
Damping ratio	2 % crit.	Av. leg drag coef.	0.74 coef.
Total weight	800 kips	Beta, top fixity	0.00 ratio
ks, soil stiff.	1.36E+04 kipft/rad	Mu, bottom fixity	0.12 ratio
su, soil und.ss.	225 psf	kj, JackHull stiff	8.00E+05 kipft/rad
Gfactor on su	16 coef.	Equiv. pad radius	8.92 feet
LCG	24 feet	TCG	0 feet
Ke0, Offset coef.	0.003 LegLength	VCG excldng. legs	5 feet
Fwd-aft leg dist	66 feet	Fwd leg spacing	50 feet
LegLength extend.	88 feet	Total leg length	130 feet

STA LIFTBOAT v1.01 December 1990

Legs are dry internally

RESULTS SUMMARY

LIFTBOAT TYPE 1

STA RIG # # N

Pad1 bef.env.loads	212 kips	Pad2 bef.env.loads	249 kips
Pad3 bef.env.loads	212 kips	Weight - buoyancy	674 kips
Av.leg buoyancy	42 kips	Total buoyancy	126 kips
Lateral Stiffness	59 kips/ft	lateral x-stiff.	59 kips/ft
Wind force	27 kips	lateral y-stiff.	62 kips/ft
Max wav-cur.force	68 kips	Mean wav-cur.force	29 kips
Wind O/T moment	2763 ft-kips	Max. total force	95 kips
Amp.wav/cur.O/Tm	2005 ft-kips	Mean wav-cur.O/Tm	1490 ft-kips
Tnxx sway period	3.53 seconds	Max.apparent O/Tm	6258 ft-kips
Tnyy sway period	3.44 seconds	Max torsion mom.	0 ft-kips
Nat. tor. period	2.94 seconds	DAF	1.14 ratio
Mean hull defln.	0.85 feet	Hull defln. amp.	0.53 feet
Max hull defln.*	1.44 feet	Offset+defln.**	1.71 feet
Uncorr.stab.mom.	10023 ft-kips	Euler leg load	1565 kips
Corr.stab.mom.	8626 ft-kips	Max. base shear	101 kips
Max.Up.guide reac.	176.8 kips	Max.low.gde.reac.	180 kips
Max.equiv.top load	84.52 kips	Max.horiz.SC.reac.	28.17 kips
BM.pad.max.w/o.PD.	284 ft-kips	BM.hull max.w/oPD.	1852 ft-kips
PDelta leg BM.max	623 ft-kips	BM.hull max. w.PD.	2475 ft-kips
PadMax.id.uncorr.	344 kips	PadMin.id.uncorr.	165 kips
PadMax.id.corrected	365 kips	PadMin.id.corrected	154 kips
Pad mean angle	0.6958 degrees	Pad max.angle	1.1959 degrees
Max.OT w/o PDelta	6542 ft-kips	Max.OT.mom.w.PD	7576 ft-kips
Max.hull ax.F1,F3	189.8 kips	Static offset **	3.17 inches
Max.hull ax.F2	389.1 kips	K-Equivalent	2.00 coef.
max fb, legs 1,3	26.08 ksi	Uncorr. O/T SF	1.60 ratio
max fb, top leg 2	22.15 ksi	Corrected O/T SF	1.32 ratio
max fa, legs 1,3	1.54 ksi	DnV O/T Safety F.	1.32 ratio
max fa, top leg 2	3.15 ksi	ABS pre-88 unity str.chk legs 1,3	0.72 ratio
Hull max.shr.str.	1.46 ksi	ABS pre-88 unity str.chk leg 2	0.82 ratio
fa/Fa ABS leg 2	0.36 ratio	Rational Unity str.chk.legs 1,3	0.65 ratio
fb/Fb ABS leg 2	0.46 ratio	Rational Unity str.chk.leg 2	0.68 ratio

FIGURE 13: OUTPUT FOR NEW DESIGN - BOW LOADING STRESS CHECK

STA LIFTBOAT v1.01 December 1990

07/30/91 Date of this run

TABLE OF RESULTS

Run Ref.: 65ft, 20/10/2 Stern Loading, Dry Legs

STA LIFTBOAT v1.01 December 1990

Boat Name: STA LIFT1

INPUT SUMMARY

LIFTBOAT TYPE 1

STA RIG # # N

Wave height	20 feet
Wave period	10 seconds
Water depth	65 feet
theta, wave dirn.	180 degrees
Wind force	COMPUTE BELOW
Leg equiv.av.dia.	3.51 feet
Damping ratio	2 % crit.
Total weight	800 kips
ks, soil stiff.	1.36E+04 kipft/rad
su, soil und.ss.	225 psf
Gfactor on su	16 coef.
LCG	24 feet
Ke0, Offset coef.	0.003 LegLength
Fwd-aft leg dist	66 feet
LegLength extend.	88 feet

Tidal current	2 knots
Wind driven curr.	0 knots
Pad penetration	3 feet
Air gap	17 feet
Wind speed	70 knots
Av. leg mass coef.	2 coef.
Av. leg drag coef.	0.74 coef.
Beta, top fixity	0.00 ratio
Mu, bottom fixity	0.12 ratio
kj, JackHull stiff	8.00E+05 kipft/rad
Equiv. pad radius	8.92 feet
TCG	0 feet
VCG excldng. legs	5 feet
Fwd leg spacing	50 feet
Total leg length	130 feet

STA LIFTBOAT v1.01 December 1990

Legs are dry internally

RESULTS SUMMARY

LIFTBOAT TYPE 1

STA RIG # # N

Pad1 bef.env.loads	212 kips
Pad3 bef.env.loads	212 kips
Av.leg buoyancy	42 kips
Lateral Stiffness	59 kips/ft
Wind force	27 kips
Max wav-cur.force	67 kips
Wind O/T moment	2763 ft-kips
Amp.wav/cur.O/Tm	1955 ft-kips
Tnxx sway period	3.53 seconds
Tnyy sway period	3.44 seconds
Nat. tor. period	2.94 seconds
Mean hull defln.	0.85 feet
Max hull de/ln.*	1.43 feet
Uncorr.stab.mom.	10023 ft-kips
Corr.stab.mom.	8638 ft-kips
Max.Up.guide reac.	163.5 kips
Max.equiv.top load	83.67 kips
BM.pad.max.w/o.PD.	282 ft-kips
PDelta leg BM.max	454 ft-kips
PadMax.id.uncorrd.	259 kips
PadMax.id.corrected	268 kips
Pad mean angle	0.6957 degrees
Max.OT w/o PDelta	6485 ft-kips
Max.hull ax.F1,F3	256.0 kips
Max.hull ax.F2	246.9 kips
max fb, legs 1,3	24.12 ksi
max fb, top leg 2	20.48 ksi
max fa, legs 1,3	2.07 ksi
max fa, top leg 2	2.00 ksi
Hull max.shr.str.	1.35 ksi
fa/Fa ABS legs 1,3	0.24 ratio
fb/Fb ABS legs 1,3	0.50 ratio

Pad2 bef.env.loads	249 kips
Weight - buoyancy	674 kips
Total buoyancy	126 kips
lateral x-stiff.	59 kips/ft
lateral y-stiff.	62 kips/ft
Mean wav-cur.force	29 kips
Max. total force	94 kips
Mean wav-cur.O/Tm	1490 ft-kips
Max.apparent O/Tm	6208 ft-kips
Max torsion mom.	0 ft-kips
DAF	1.14 ratio
Hull defln. amp.	0.52 feet
Offset+defln.**	1.69 feet
Euler leg load	1565 kips
Max. base shear	100 kips
Max.low.gde.reac.	167 kips
Max.horiz.SC.reac.	27.89 kips
BM.hull max.w/oPD.	1835 ft-kips
BM.hull max. w.PD.	2289 ft-kips
PadMin.id.uncorrd.	155 kips
PadMin.id.corrected	137 kips
Pad max.angle	1.1837 degrees
Max.OT.mom.w.PD	7281 ft-kips
Static offset **	3.17 inches
K-Equivalent	2.00 coef.
Uncorr. O/T SF	1.61 ratio
Corrected O/T SF	1.38 ratio
DnV O/T Safety F.	1.33 ratio
ABS pre-88 unity str.chk legs 1,3	0.74 ratio
ABS pre-88 unity str.chk leg 2	0.65 ratio
Rational Unity str.chk.legs 1,3	0.65 ratio
Rational Unity str.chk.leg 2	0.55 ratio

FIGURE 14: OUTPUT FOR NEW DESIGN - STERN LOADING STRESS CHECK

PAD VERTICAL REACTIONS, INC. RESPONSE

65ft, 20/10/2 Limiting Preload, Dry Legs

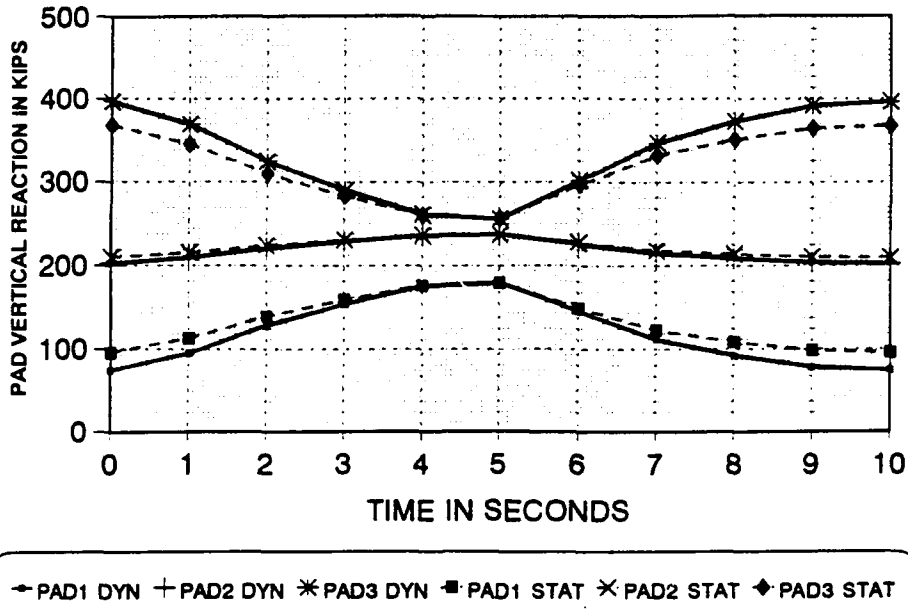

FIGURE 15

PAD VERTICAL REACTIONS, INC. RESPONSE

65ft, 20/10/2 Limiting O/T SF, Dry Legs

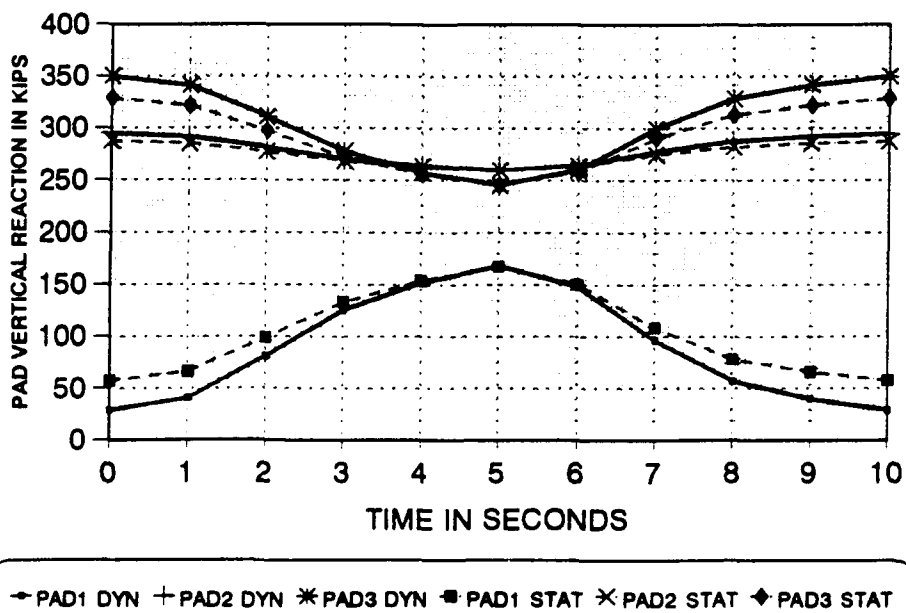

FIGURE 16

PAD VERTICAL REACTIONS, INC. RESPONSE

65ft, 20/10/2 Beam Loading, Dry Legs

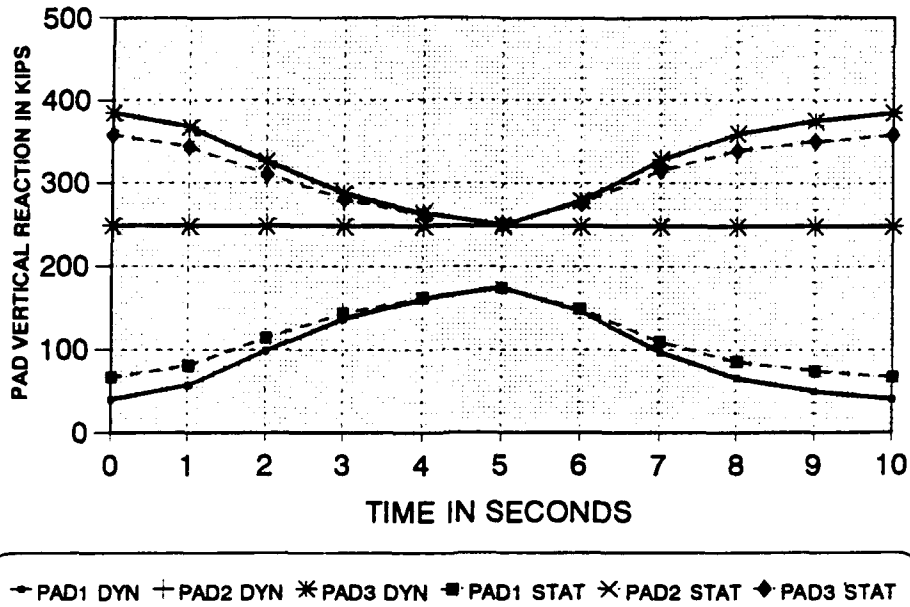

FIGURE 17

PAD VERTICAL REACTIONS, INC. RESPONSE

65ft, 20/10/2 BOW Loading, Dry Legs

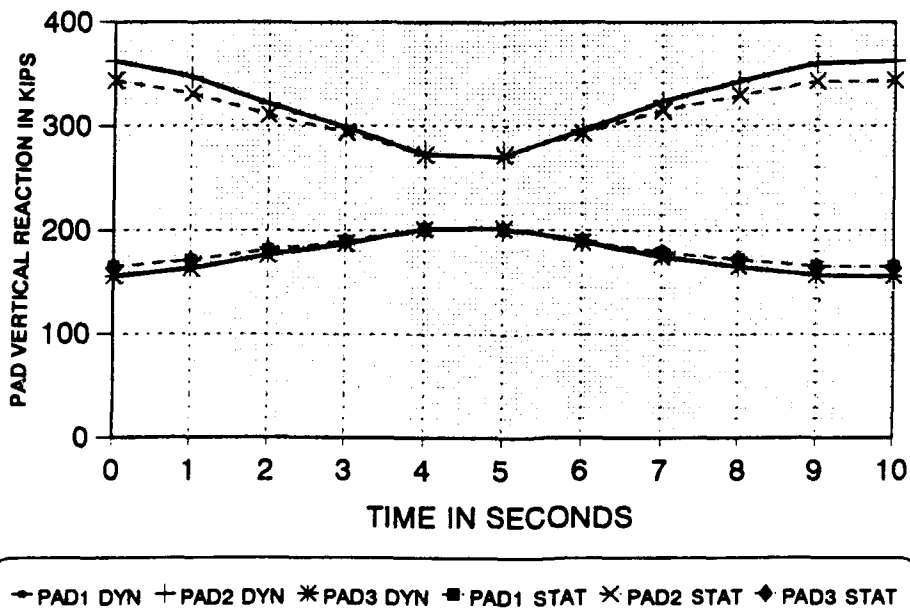
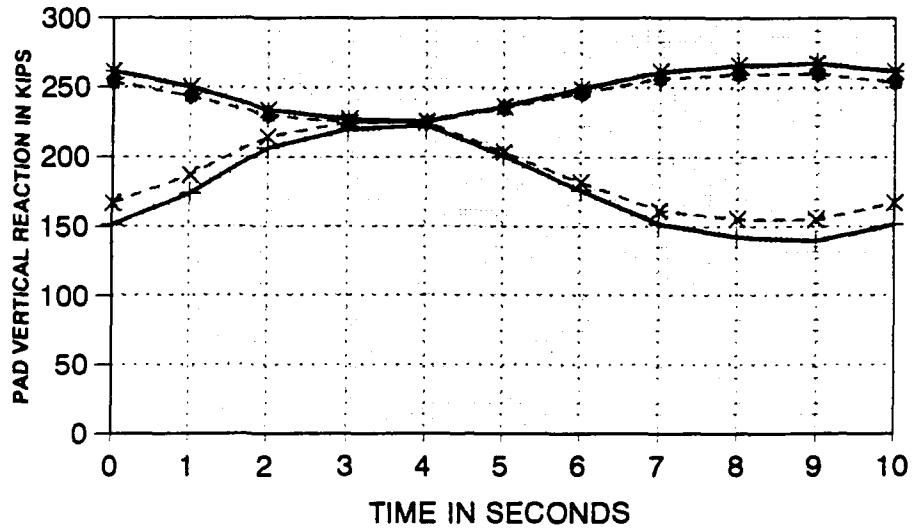

FIGURE 18

PAD VERTICAL REACTIONS, INC. RESPONSE

65%, 20/10/2 Stern Loading, Dry Legs



→ PAD1 DYN + PAD2 DYN * PAD3 DYN ■ PAD1 STAT × PAD2 STAT ◆ PAD3 STAT

FIGURE 19

APPENDIX 1

Wind Loading Methodology

In the Interim Report for this project (Reference 1) wind loading methodology is explained in some detail. The purpose of this appendix is not to duplicate that work but to highlight the most important considerations when calculating wind loads on liftboats.

Wind loading analysis should follow the procedures described in the ABS Rules (Reference 3). The drag coefficients used on the leg sections below the hull (in the air gap) and above the hull should be the same as drag coefficients used for wave loading analysis. Due account should be taken of the effect of the rack(s) increasing the drag coefficient in certain directions.

Care should be taken to estimate the lateral center of wind pressure, in particular when calculating responses induced by wind forces on the beam. The center of pressure is not likely to coincide with the geometric leg center. Therefore, there will usually be a torsional moment induced by the wind load from beam directions. Care should also be taken to correctly account for the longitudinal movement of the center of pressure as the wind direction is varied. The lateral center of pressure on the hulls and superstructures of liftboats may normally be expected to be on the vessel centerline. Refer to Appendix 7 of this report for guidance on accounting for torsional displacements, moments, and stresses.

When calculating wind loads for the purposes of liftboat design, some allowance should be made for cargo on the deck of the liftboat.

Selection of wind speed may be site-specific or a design wind speed may be selected for a liftboat design. 70 knots should be regarded as a minimum design wind speed, in combination with a design wave height and current velocity, for elevated conditions for liftboats intended for restricted service. For liftboats intended for unrestricted service, 100 knots is recommended as the design wind speed for elevated conditions in the Gulf of Mexico, in combination with a design wave height and current velocity, as described in Section 2 and summarized in Section 7 of this report.

APPENDIX 2

Wave Loading Methodology

In the Interim Report (Reference 1) considerable detail is provided on wave loading methodology. The purpose of this appendix is not to duplicate that work, but to draw attention to the most important points.

Normally the wave theory to be used should be a shallow water wave theory. The wave theory, published as a series of graphs, in Appendix A of the ABS Rules (Reference 3), is a suitable wave theory. In the Interim Report it is shown that this theory is generally conservative while following the correct trends associated with water particle kinematics in different water depths, and wave height-period combination regimes.

The calculation of the combined effect of waves in the presence of current can be made in accordance with the method presented in the Interim Report (Reference 1) which is taken from published guidelines by Det Norske Veritas (Reference 5).

Calculation of appropriate drag coefficients, taking full account of the effect of the rack(s) is described in the Interim Report. It should be noted that it may be appropriate to use different drag coefficients on each leg depending upon the direction of the wave and current loading. This may be particularly important where torsional loading is induced by both the wind and the waves.

In most design wave cases the hydrodynamic loading on the legs will be dominated by drag forces. However, inertia forces will be important in short period waves. The appropriate inertia coefficient to use for the legs is 2.0, together with the effective diameter described in Reference 1.

The wave loading during the passage of a wave must be accounted for on each leg taking careful account of the wave phase angle at each leg. In short period waves it may be possible to have wave cancellation effects such that one leg is seeing the opposite of the load imposed on the other two legs.

It is not normally considered necessary to calculate loading and response using the relative velocity between the legs and the water particles, accounting for leg movement as the liftboat sways (that is, the sway velocity of the legs may be neglected). However, where the natural sway period is in excess of 3 seconds, and where the wave period of interest is within 25% of the natural sway period, the equivalent linear damping term in the dynamic response calculation may be increased to a maximum of 8% critical.

It is not considered necessary to account for the vertical hydrodynamic pressure loading on the pads as the wave passes.

APPENDIX 3

Geotechnical Considerations

In the Interim Report (Reference 1) Appendix VI is entitled "SOME IMPORTANT GEOTECHNICAL CONSIDERATIONS" and describes the concept of bearing capacity and load versus penetration curves for liftboat pads.

The main geotechnical consideration for a liftboat going onto any location is the adequacy of the seabed soil to support the footing. Additionally, the penetration of the footing should be estimated in advance of elevating the hull, allowing for the necessary preload that must be added (and then dumped, before elevating to the desired operating air gap). This is necessary to ensure that sufficient leg length is available to operate safely at this location. Furthermore, if this is a marginal location, the soil stiffness providing rotational restraint to the liftboat footings should be estimated. The minimum required preload will vary from location to location. It is a function of the water depth, soil strength, and the maximum predicted environmental conditions at the selected location. It is also a function of the variable load to be carried in the final elevated position. The fundamental requirement is to achieve a vertical preload reaction on the soil which, ideally, is in excess of the maximum vertical reaction that will occur in the design environment for that location, with that particular variable load configuration. In fact, it is a vertical pad displacement consideration that must be satisfied since a small amount of additional vertical penetration may be tolerable. Typically for a liftboat a further penetration of any single footing which causes a rotation of the hull of no more than one half degree from perfectly level may be tolerable.

The rotational restraints provided to the footings by the soil are discussed in References 1 and 2. The procedure recommended is also included on page 13 of Appendix 6 to this Final Report. This rotational restraint is difficult to calculate, but a maximum ultimate capacity may be found more easily. In liftboat design it is appropriate to consider quite weak soil characteristics, resulting in a K-factor (effective length) for the legs of 2.0. This weak soil consideration is needed in order to design the vessel safely against overturning, leg over-stress at the level of the lower guides, and exceedance of preload. Additionally this factor of 2.0 allows for some eccentric loading on the pads from uneven sea bed conditions. Conversely, it is sensible to consider rather high soil stiffness in order to calculate stresses in the legs at the pads in order to design against fatigue failure at this point.

Using a plastic analysis, a limiting, or ultimate moment capacity, for the footing of the liftboat can be calculated. The ultimate moment capacity of the footing dictates the maximum rotational footing restraint that may exist at a particular location. This term may be used to find the maximum permissible value of stiffness for a rotational spring at the footing. This rotational spring stiffness may

be used to find the minimum K-factor value that should be used for the liftboat leg at a particular location, under a particular set of load conditions. The procedure is explained below and a table of examples is provided.

The equation below gives the ultimate moment capacity for a rectangular footing loaded by a moment about the lengthwise axis.

$$M_{ult} = 0.25\pi(\text{width})^2(\text{length})s_u + 0.0833\pi(\text{width})^3s_u$$

Where:

- M_{ult} = ultimate moment capacity of footing for this soil and load direction
- width = width of rectangular footing
- length = length of rectangular footing
- s_u = undrained shear strength of cohesive soil beneath footing.

A similar expression can be developed for non-cohesive soils. The value for s_u should reflect the soil strength gradient beneath the footing. If it is uniform, or increasing slowly, the value for s_u may be the average value at a depth equal to half the footing width. Similar expressions can be developed for any footing geometry.

The failure surface is conservatively assumed to be semi-cylindrical, with the bottom of the pad coincident with the diameter of the cylinder. The undrained shear strength is mobilized throughout the failure surface, including the two semi-circular vertical planes beneath the two ends of the pad. A diagram of the failure surface is shown in Figure A3-1, where the more commonly considered failure surface for principally vertical, eccentric loading is also shown. The conservative cylindrical surface is strictly applicable to pure applied moments with the vertical load at some value less than the pre-load value. The moment capacity may be reduced if applied vertical loads are close to maximum preload levels, although the failure surface will be similar to the one labeled "non-conservative" in Figure A3-1. Conversely, if the applied vertical load is reduced to near zero, the moment capacity will be reduced, but not by much in cohesive soils, since an upward suction develops beneath the side of the pad being lifted (at wave cycle frequency). The moment capacity will also be reduced by horizontal loads, but this may also be a small effect for typical liftboat pads.

Table A3-1 on the following page has been developed using the following procedure, with the basic geometry of the generic liftboat:

- Step 1 *Select pad penetration and environmental conditions*
- Step 2 *Calculate applied loads (including weight)*
- Step 3 *Select a wall thickness for the liftboat legs*
- Step 4 *Calculate response, including maximum pad vertical reaction*
- Step 5 *Calculate the necessary minimum value for s_u to support foundation load*
- Step 6 *Calculate M_{ult} , ultimate moment capacity of foundation, given this s_u*
- Step 7 *Compare M_{ult} with max moment developed at pad*
- Step 8 *adjust G_{factor} until the values in Step 7 are the same*
- Step 9 *Check the equivalent K-factor that results from the above procedure*

Table A3-1; Leg K-Factors and Soil Moment Capacities

Severe Storm Conditions, New Design, Beam Loading

Water depth = 65 feet Current = 2 knots
 Pad penetration = 3 feet Wind speed = 70 knots
 Wave height = 20 feet Wave period = 10 seconds

Leg wall thickness (Inches)	Soil Su needed (psf)	Max.Pad Reaction (kips)	Soil Mult (ft-kips)	Max.Leg Unity Check	Min.O/T Safety Factor	Gfactor to get Mult	K-factor which results
1.25	377	263	587	0.54	1.23	48	1.83
1.00	380	266	599	0.71	1.20	39	1.84
0.75	388	271	606	1.07	1.16	29	1.85
0.50	404	282	628	2.35	1.06	19	1.86

Severe Storm Conditions, New Design, Beam Loading

Water depth = 58 feet Current = 2 knots
 Pad penetration = 10 feet Wind speed = 70 knots
 Wave height = 20 feet Wave period = 10 seconds

Leg wall thickness (Inches)	Soil Su needed (psf)	Max.Pad Reaction (kips)	Soil Mult (ft-kips)	Max.Leg Unity Check	Min.O/T Safety Factor	Gfactor to get Mult	K-factor which results
1.25	384	237	527	0.59	1.17	43	1.88
1.00	388	240	534	0.79	1.15	34	1.88
0.50	415	256	570	2.77	1.00	17	1.91

Severe Storm Conditions, New Design, Beam Loading

Water depth = 48 feet Current = 2 knots
 Pad penetration = 20 feet Wind speed = 70 knots
 Wave height = 20 feet Wave period = 10 seconds

Leg wall thickness (Inches)	Soil Su needed (psf)	Max.Pad Reaction (kips)	Soil Mult (ft-kips)	Max.Leg Unity Check	Min.O/T Safety Factor	Gfactor to get Mult	K-factor which results
1.00	403	213	474	0.90	1.06	30	1.93
0.50	435	230	512	3.59	0.92	14	1.95

Mild Storm Conditions, New Design, Beam Loading

Water depth = 65 feet Current = 2 knots
 Pad penetration = 3 feet Wind speed = 50 knots
 Wave height = 5 feet Wave period = 10 seconds

Leg wall thickness (Inches)	Soil Su needed (psf)	Max.Pad Reaction (kips)	Soil Mult (ft-kips)	Max.Leg Unity Check	Min.O/T Safety Factor	Gfactor to get Mult	K-factor which results
1.00	267	186	414	0.18	3.71	1000	1.21
0.50	268	188	418	0.38	3.60	420	1.25

Mild Storm Conditions, New Design, Beam Loading

Water depth = 58 feet Current = 2 knots
 Pad penetration = 10 feet Wind speed = 50 knots
 Wave height = 5 feet Wave period = 10 seconds

Leg wall thickness (Inches)	Soil Su needed (psf)	Max.Pad Reaction (kips)	Soil Mult (ft-kips)	Max.Leg Unity Check	Min.O/T Safety Factor	Gfactor to get Mult	K-factor which results
1.00	267	165	367	0.21	3.71	455	1.35
0.50	269	166	369	0.46	3.56	205	1.40

Mild Storm Conditions, New Design, Beam Loading

Water depth = 48 feet Current = 2 knots
 Pad penetration = 20 feet Wind speed = 50 knots
 Wave height = 5 feet Wave period = 10 seconds

Leg wall thickness (Inches)	Soil Su needed (psf)	Max.Pad Reaction (kips)	Soil Mult (ft-kips)	Max.Leg Unity Check	Min.O/T Safety Factor	Gfactor to get Mult	K-factor which results
1.00	267	142	316	0.25	3.66	277	1.50
0.50	271	143	318	0.56	3.47	129	1.55

From review of Table A3-1 the following important observations are made.

***The largest resulting K-factors occur in severe storm conditions
K-factors slightly increase with decreasing wall thickness***

The principal reason for the above effects is that the pad is rotated by the leg through larger angles in harsher storm conditions. Given a particular rotational stiffness, the larger the rotation of the pad, the larger will be the moment developed. Hence if the ultimate moment capacity of the soil is reached, it is with rather small G_{factor} values and large rotations in storms, or with rather large G_{factor} values and small rotations in mild conditions. This is commensurate with the knowledge that the soil shear modulus, G , is large at small strains and decreases rapidly at large strains.

At deep embedment values, the failure surface area is under-estimated by the above method, as soil will fall back onto the top of the pads and the failure surface becomes nearly a full cylinder. However, the fallen soil is initially highly remolded and has a much lower shear strength than the soil beneath the pads. With time this soil will regain some strength, but initially the above procedure is reasonable in ignoring the fallen soil.

The above method can be repeated, but with the soil s_u value reached during preload, at an average depth beneath the pad equal to half the pad width. Somewhat smaller values of the resulting K-factors will then be found.

For rotation of the pads about their length, rather than their width, axis, larger ultimate rotational moments are available. However, at intermediate angles of applied moment the failure surface area will generally be closer to the value for the smaller axis. Hence an improvement in pad design would be to increase pad width and reduce pad length to achieve the same pad area.

ULTIMATE MOMENT CAPACITY: LIFTBOAT FOUNDATION PADS

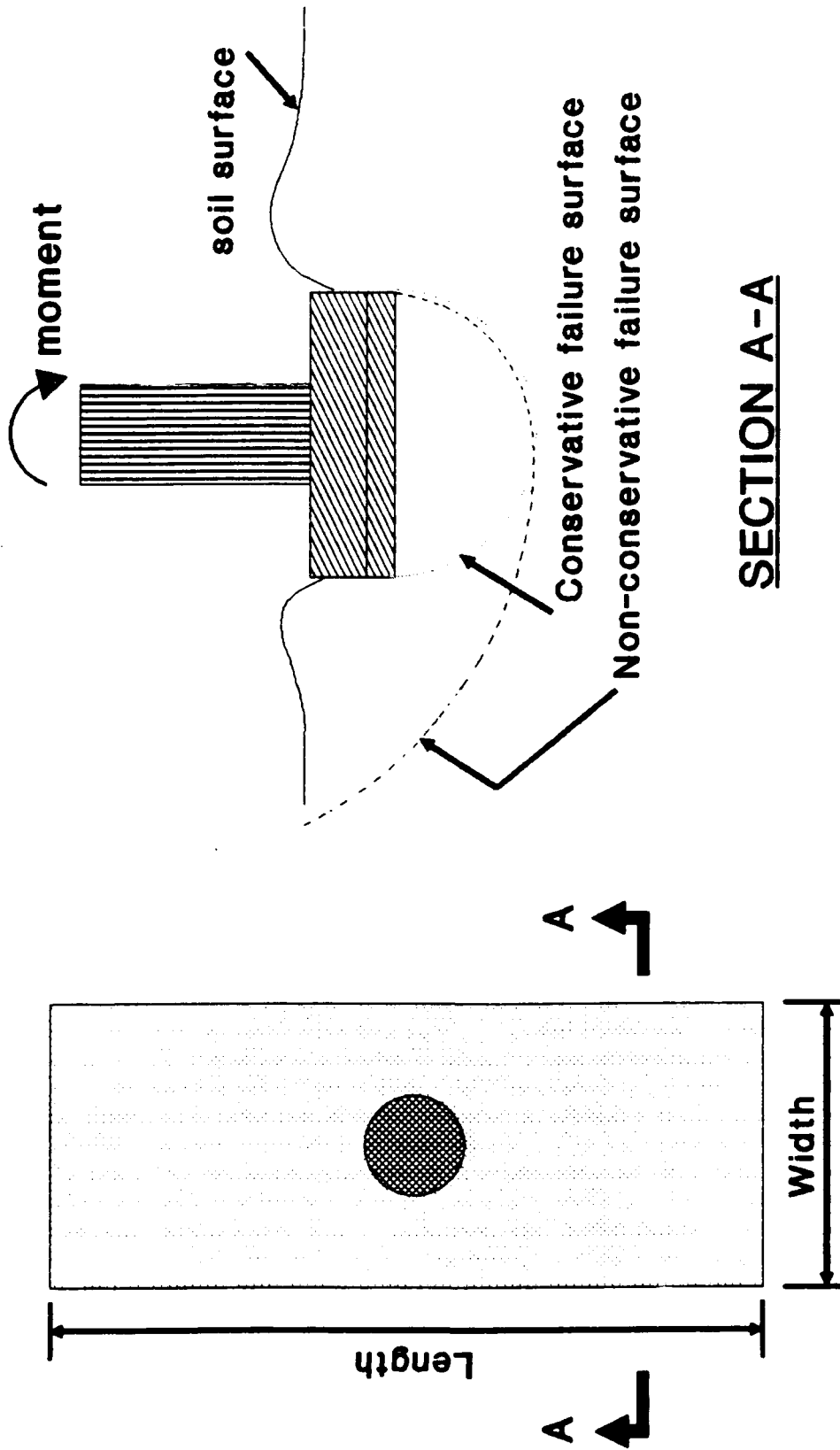

SECTION A-A

PLAN VIEW OF PAD

FIGURE A3-1

APPENDIX 4

Computer Program for Analysis of Liftboats

STA LIFTBOAT Release 1.0

STA LIFTBOAT Release 1.0 is an interactive program for the analysis of liftboats in the elevated condition. The program performs wind loading, together with wave and current loading calculations. The user can easily investigate the results of changes in leg properties, hull weights, variable loads, seabed soils, as well as environmental loading. STA LIFTBOAT performs static and dynamic response analysis, including calculation of hull sway and pad rotations at the bottom of the leg.

All primary input is performed on a spreadsheet displayed on the screen of your PC. Just load the spreadsheet (in Lotus SYMPHONY) edit the single screen of data, press Alt-A, and the program runs. An intermediate set of results is presented, and the user has an opportunity to view all important parameters as graphs. Press Alt-S and all graphs are saved as plot files; press Alt-N and the program continues with its static and dynamic response analysis. The program displays a single-page TABLE OF RESULTS, summarizing all important input terms and computed responses, including factors of safety against overturning, ABS/USCG unity stress checks for each leg, and maximum pad vertical reactions on the sea bed. On an AT type PC this takes less than four minutes, including saving the graphs and printing the results table.

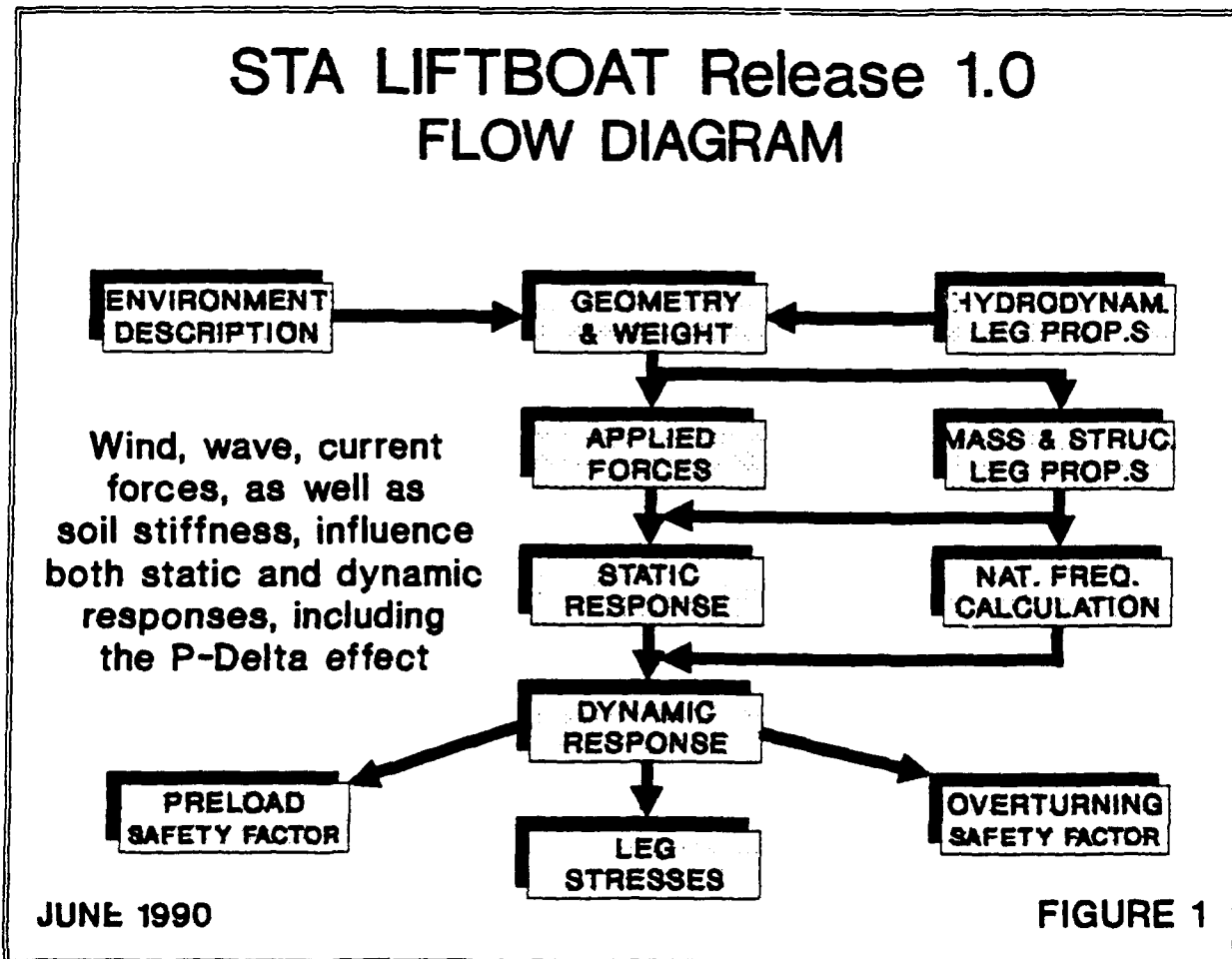

Figure 2 below shows the initial data input screen. The shaded cells only can be edited with user-defined input data and will appear highlighted on your PC screen (in color if you have a color monitor). The values displayed when the spreadsheet is loaded are from the last run which were automatically saved when the user pressed the keys Alt-A.

STA LIFTBOAT v1.0 June 1990				06/25/90 Date of this run	
!!!! THIS IS THE DATA INPUT & INTERMEDIATE PROCESSING FILE !!!!					
AFTER ALL DATA IS INPUT/CHANGED, PRESS ALT-A. RESULTS FILE WILL LOAD.					
PRINTING: Alt-P for input; Alt-W for wind.				Boat name: Generic Liftboat	
Run Ref.:		65ft water, 20ft/10sec wave, 1 knot current		<<<appears on graphs	
COPYRIGHT 1990 STEWART TECHNOLOGY ASSOCIATES					
This spreadsheet program uses the ABS 1985 Rules method for finding wave forces on a LIFTBOAT. The user is prompted for data, and for controls.					
Only data in shaded cells can be edited. Last data used is displayed.					
EDIT INPUT DATA		5 AvShield		90 1st wave angle (deg)	
20	Input wave height (ft)	9.51	9.51	9.51	Leg diams 1,2,3 (ft)
10	Input wave period (sec)	2	2	2	Cm1, Cm2, Cm3
65	Input water depth (ft)	0.7	0.61	0.7	CD1, CD2, CD3
100	Lattice area (sqft)	30 lattice av.ht.		70 wind v2 (kn)	
19	WH1 (ft)	30	WH2 (ft)	0 wind v1 (kn)	
90	WB (ft)	36	WL (ft)	1 tide vel (kn)	
66	distance from aft to fwd legs (ft)	6.32 LeverArm		1026 Total weight (kips)	
50	distance bet. fwd. leg centers (ft)			22 LCG (ft to aft legs)	
3	pad penetration int	1 Leg buoy.coef.		0 TCG (+ve towards L1)	
20	windforce kips	17 air gap (ft)		0 init phase ang (deg)	
Wind force switch:		2 (1=input; 2=computed)		10 wind elev (ft)	
				136 tot. leg length (ft)	

**MAIN DATA INPUT SCREEN
FIGURE 2**

Figure 3, on the next page, shows the second and final input screen. This screen is presented after the user has pressed Alt-A, and then Alt-N. Available options in this and in the first input screen are discussed on the following pages. After the user has edited the second data input screen and pressed Alt-A again, the program displays a TABLE OF RESULTS. This table summarizes the input data and all key results for loading and response. An example of a typical TABLE OF RESULTS is shown in Figure 4, for the input specified in Figures 2 and 3, for a typical liftboat.

Note that wind, wave, and current loading is developed initially based upon the information provided by the user on the main data input screen (Figure 2). With the additional information provided by the user in the final processing file (Figure 3) the structural response of the liftboat to this applied loading is computed. The response is found both statically and dynamically, although dynamics can be "switched off" for comparison purposes.

Footing reactions, leg stresses, and safety factors against overturning may be strongly influenced by the dynamic sway response of the vessel hull which causes secondary bending moments in the legs. In this respect the soil/structure interaction at the pads may be important, as relatively large moments may be induced in the legs at the level of the pads, as a consequence of soil stiffness resisting the rotation of the pads.

STA LIFTBOAT v1.0 June 1990		06/26/90 Date of run
FINAL PROCESSING FILE		Boat Name: Generic Liftboat
Run Ref.: 86ft water, 20ft 10sec wave, 1 knot current		<appears on graphs
Press Alt-S to save graphs, Alt-A for RESULTS SUMMARY, Alt-B for stress check Press Alt-I to print this input, Alt-R for results, Alt-C for stress checks		
EDIT USER DEFINED VARIABLES		
4248000	Young's Modulus, leg steel (ksf)	1.91 K-equivalent
1	nat.period multiplier (norm.=1; no dyn.=.01)	
60	yield stress for leg steel	1 add.mass coef.(norm.=1)
2	accept calc. wt/ft (1=no, 2=yes)	5 VCG excluding legs (ft)
2	accept hull gyrad. (1=no, 2=yes)	15 weight of 1 pad (kips)
40	coef.on su to get soil G modulus	0.443 calculated leg kips/ft
160	su, soil und.shear str. (psf)	30.18 calculated hull gyrad.
24230.585	ks, calc.rot.stiff.soil (kip-ft/rad)	0.28 USER SPEC.leg kips/foot
8.00E+05	kj, rot.stiff.jack/hull (kip-ft/rad)	90 USER SPEC. gyrad. (ft)
21.11	k, calc.overall leg stiff.(kips/ft)	0.00 Beta, calculated
0	Ke0, horiz.offset coef.	0.18 Mu, calculated
0.64	cylinder drag coef.(w/marine growth)	2 total damping (% crit.)
0.00	marine growth thickness (inches)	0 Beta maximum
INPUT STRUCTURAL LEG DATA BELOW:		
3	VCG lower guide (ft)	1 geometry select.switch
42	leg OD (in)	14 d, guide spacing (ft)
0.85	wall thickness (in)	7 b, jack vcg (ft)
4	rack width (in)	4.5 h, jack support spacing (ft)
4	rack height to top teeth (in)	25 pad length (ft)
1.5	rack height to bot. teeth (in)	10 pad width (ft)
4.5	stiffener area in sqin	1.5 pad 1/2 height (ft)
0.04	leg wt.factor for appendages, etc	1 1 OR 2 RACK SWITCH
2ND Title for drag coefficient graph >>>>		LIFTBOAT 42 INCH DIAMETER LEG

**INTERMEDIATE DATA INPUT SCREEN
FIGURE 3**

It is emphasized that STA LIFTBOAT can be run simply to find environmental loading on a liftboat, without proceeding to investigate responses. This may be achieved by considering only the maximum apparent forces and moments in the TABLE OF RESULTS, and by considering only the uncorrected pad reactions and uncorrected safety factor against overturning. Alternatively, STA LIFTBOAT may be run to investigate environmental loading and static responses, without dynamics. This may be achieved by setting the Natural Period Multiplier (first input term in Figure 3) to a small value, for example, 0.01. If this is done the Dynamic Amplification Factor (DAF) will be set to virtually zero and static responses will be the same as dynamic responses.

STARTING THE ANALYSIS

The first step in the analysis of a liftboat is the establishment of wind areas and equivalent leg hydrodynamic properties so that environmental loading can be computed. See the section on wind loading later in this manual. Equivalent leg diameter and drag coefficients are calculated in the final processing file (input shown in Figure 3). These coefficients must be taken from the final processing file and input on the MAIN DATA INPUT SCREEN (see Figure 2). Environmental conditions, water depth, air gap, spud can penetrations, leg lengths and spacing, etc., are all defined by the user at this point by editing the highlighted data.

STA LIFTBOAT v1.0 June 1990

06/27/90 Date of this run

TABLE OF RESULTS Run Ref.: 65ft water, 20ft/10sec wave, 1 knot current

<i>STA LIFTBOAT v1.0 June 1990</i>		Boat Name: Generic Liftboat	
INPUT SUMMARY		LIFTBOAT TYPE 1	STA RIG # # N
Wave height	20 feet	Tidal current	1 knots
Wave period	10 seconds	Wind driven curr.	0 knots
Water depth	65 feet	Pad penetration	3 feet
theta, wave dirn.	90 degrees	Air gap	17 feet
Wind force	COMPUTE BELOW	Wind speed	70 knots
Leg equiv.av.dia.	3.51 feet	Av. leg mass coef.	2 coef.
Damping ratio	2 % crit.	Av. leg drag coef.	0.74 coef.
Total weight	1026 kips	Beta, top fixity	0.00 ratio
ks, soil stiff.	2.42E+04 kipt/rad	Mu, bottom fixity	0.18 ratio
su, soil und.ss.	160 psf	kj, JackHull stiff	8.00E+05 kipt/rad
Gfactor on su	40 coef.	Equiv. pad radius	8.92 feet
LCG	22 feet	TCG	0 feet
Ke0, Offset coef.	0 LegLength	VCG excludng. legs	5 feet
Fwd-aft leg dist	66 feet	Fwd leg spacing	50 feet
LegLength extend.	88 feet	Total leg length	130 feet

<i>STA LIFTBOAT v1.0 June 1990</i>		<i>Legs are dry internally</i>	
RESULTS SUMMARY		LIFTBOAT TYPE 1	STA RIG # # N
Pad1 bef.env.loads	300 kips	Pad2 bef.env.loads	300 kips
Pad3 bef.env.loads	300 kips	Weight - buoyancy	900 kips
Av.leg buoyancy	42 kips	Total buoyancy	126 kips
Lateral Stiffness	63 kips/ft	lateral x-stiff.	60 kips/ft
Wind force	37 kips	lateral y-stiff.	63 kips/ft
Max wav-cur.force	55 kips	Mean wav-cur.force	14 kips
Wind O/T moment	3552 ft-kips	Max. total force	92 kips
Amp.wav/cur.O/Tm	2160 ft-kips	Mean wav-cur.O/Tm	788 ft-kips
Tnxx sway period	3.95 seconds	Max.apparent O/Tm	6499 ft-kips
Tnyy sway period	3.84 seconds	Max torsion mom.	365 ft-kips
Nat. tor. period	3.25 seconds	DAF	1.17 ratio
Mean hull defln.	0.76 feet	Hull defln. amp.	0.54 feet
Max hull defln. *	1.3 feet	Offset+defln. **	1.37 feet
Uncorr.stab.mom.	14022 ft-kips	Euler leg load	1669 kips
Corr.stab.mom.	12476 ft-kips	Max. base shear	99 kips
Max.Up.guide reac.	149.5 kips	Max.low.gde.reac.	178 kips
Max.equiv.top load	86.49 kips	Max.horiz.SC.reac.	28.83 kips
BM.pad.max.w/o.PD.	446 ft-kips	BM.hull max.w/oPD.	1848 ft-kips
PDelta leg BM.max	631 ft-kips	BM.hull max. w.PD.	2479 ft-kips
PadMax.id.uncorrd.	430 kips	PadMin.id.uncorrd.	170 kips
PadMax.id.corrected	462 kips	PadMin.id.corrected	138 kips
Pad mean angle	0.5805 degrees	Pad max.angle	1.0545 degrees
Max.OT w/o PDelta	6872 ft-kips	Max.OT.mom.w.PD	7991 ft-kips
Max.hull ax.F1,F3	317.1 kips	Static offset **	0.00 inches
Max.hull ax.F2	298.0 kips	K-Equivalent	1.91 coef.
max fb, legs 1,3	22.69 ksi	Uncorr. O/T SF	2.16 ratio
max fb, top leg 2	26.85 ksi	Corrected O/T SF	1.75 ratio
max fa, legs 1,3	2.63 ksi	DnV O/T Safety F.	1.82 ratio
max fa, top leg 2	2.48 ksi	K=2 Unity chk.legs1,3	0.87 ratio
Hull max.shr.str.	1.48 ksi	K=2 Unity chk.leg2	0.94 ratio
fa/Fa ABS leg 2	0.28 ratio	K-equiv.Un.chk.legs1,3	0.83 ratio
fb/Fb ABS leg 2	0.56 ratio	K-equiv.Un.chk.leg2	0.90 ratio

**MAIN RESULTS SUMMARY TABLE
FIGURE 4**

LEG STRUCTURAL PROPERTIES

The structural data required for the legs are input in the final processing file (see Figure 3). The principal data items are illustrated in Figure 5, below. Additionally the user must specify the leg steel yield stress and the guide geometry in terms of the distance between the guides (input as upper guide VCG), the average height of the pinions above the lower guide (input as jack VCG), and the jack support spacing (only used if legs have twin racks).

Take care to set the 1 OR 2 RACK SWITCH to either 1, for a single rack leg, or to 2, for a twin rack leg. When twin racks are modelled, the program assumes the racks are identical and internal stiffening is symmetric, with area A (see Figure 5) on both sides. The calculated area moments of inertia for the leg are output with the stress check results. The leg weight per foot is calculated by the program and uses a factor for appendages which must be specified by the user. A value of 0.04, as shown in Figure 3, indicates that 4% additional weight to the basic structural weight is in appendages (which includes weld metal allowance).

The geometry selection switch allows the user to model liftboats with the most common leg arrangements. Figure 6, on the next page, shows the six alternative arrangements for layout of the racks and legs. Set the geometry switch to 1, 2, or 3, to suit the geometry of the vessel being analyzed. Error messages will be given in the table of results if values outside this range are given. Similar error messages are given if the rack switch is not set to either 1, or 2.

Pad geometry is specified as pad length, width, and pad 1/2-height. STA LIFTBOAT uses this data to calculate soil rotational springs beneath each leg, based upon the soil properties specified for each run.

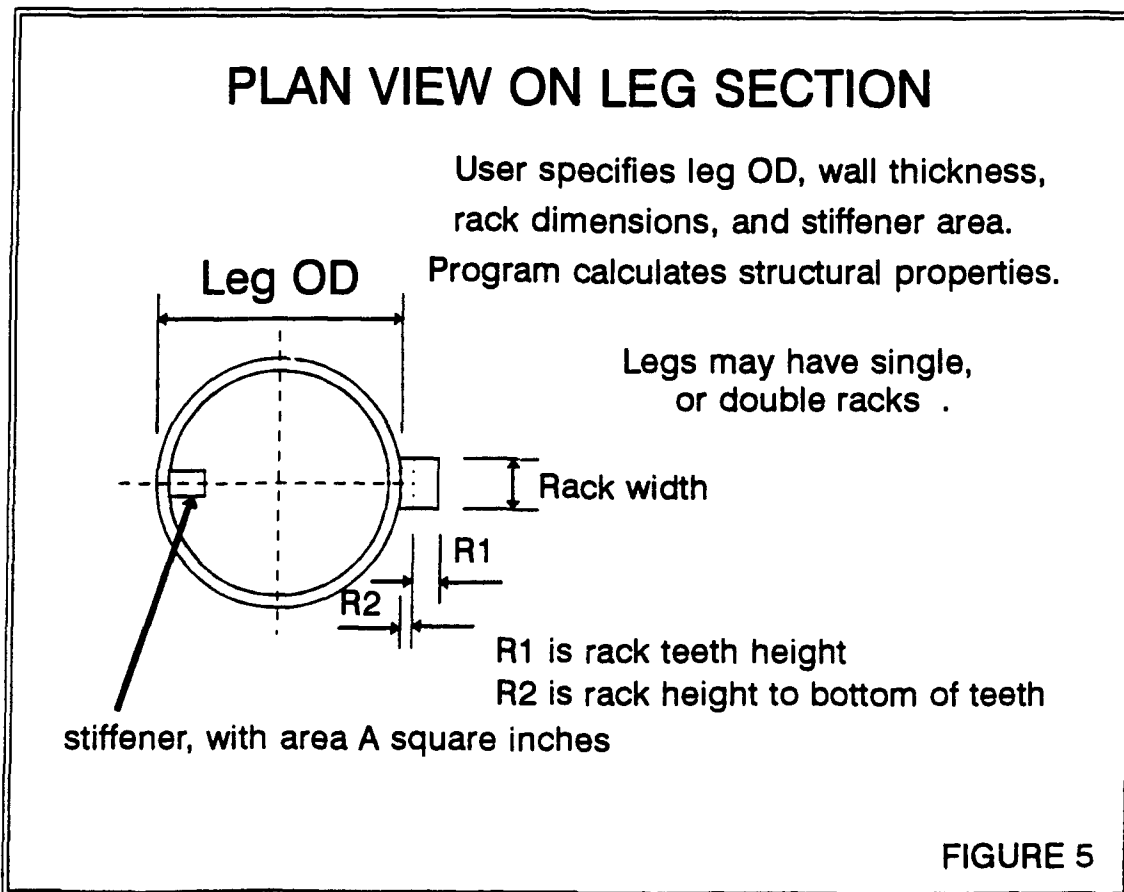

ALTERNATIVE LEG & RACK GEOMETRY ARRANGEMENTS

In each case (Selection 1, 2, or 3) the rack may be single or double, and internal stiffening may or may not be present

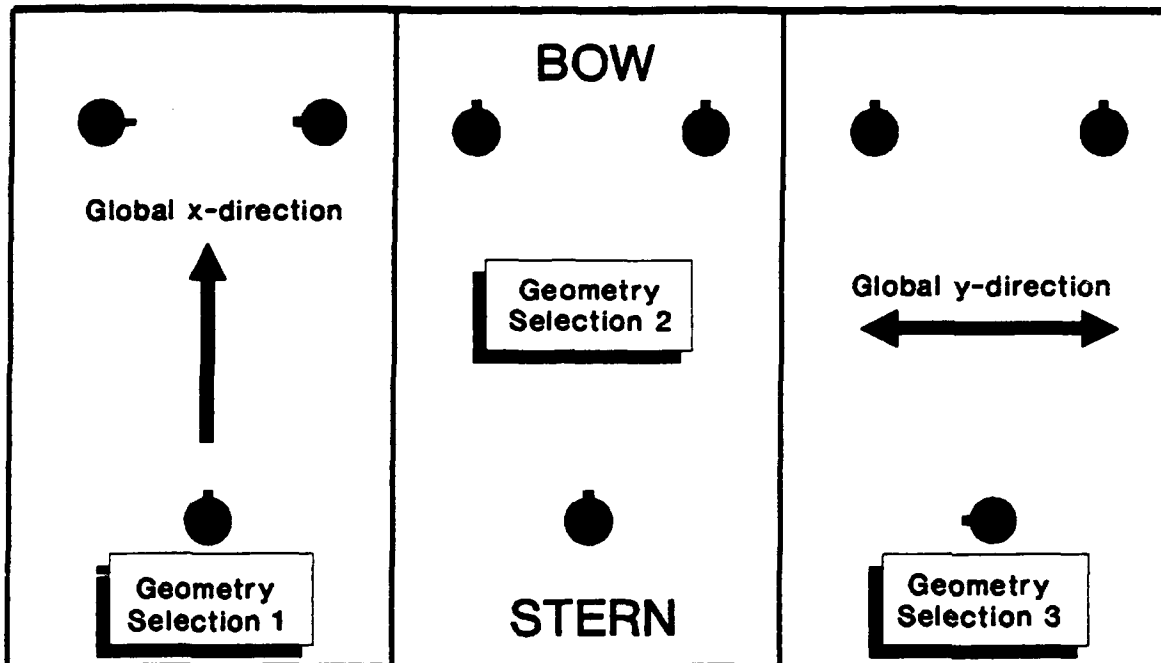

FIGURE 6

HYDRODYNAMIC COEFFICIENTS

Although liftboat legs are cylindrical, their effective diameter should be modified to account for the volume of the rack(s) and any other appendages on the legs. This is done automatically in STA LIFTBOAT when the rack dimensions are specified as part of the INPUT STRUCTURAL LEG DATA (see Figures 3 & 5). Additionally two terms in the INTERMEDIATE DATA INPUT (see Figure 3) provide the user with an opportunity to investigate the effect of surface roughness and marine growth on the legs. For new rigs, the **cylinder drag coefficient** should be set to 0.62 (ABS requirements, 1990, or 0.64 for DnV) and the **marine growth thickness** should be set to zero. The program will then calculate the equivalent leg diameter and produce a graph showing how the drag coefficient varies with wave attack angle. A typical graph of leg drag coefficient is shown in Figure 7, for the input given in Figure 3.

Note that two lines appear on this graph and the equivalent leg diameter is also given. One curve is computed according to a DnV formula (Reference 1) and the other according to a more recently published formula by Shell, The Hague (Reference 2). It is generally acceptable to take the maximum drag coefficient value and use it for each leg, irrespective of wave direction. This may be unnecessarily conservative, depending upon the sensitivity of the coefficient to wave direction, and upon the relative orientations of the legs. In some cases it may be appropriate to use a different drag coefficient on each leg.

To investigate the effect of surface roughness on the cylindrical members of any leg, change the **cylinder drag coefficient** from 0.64 to say, 1.0, to simulate a rough corroded surface, or one covered with barnacles. The roughness of the racks does not

contribute to their part of the total drag coefficient since they are angular sections and the viscous flow effects causing drag are dominated by the sharp edges of these sections. However, the drag coefficient for cylindrical sections is strongly influenced by roughness.

Marine growth not only changes surface roughness, but also changes the exposed areas and volumes of leg members. The drag changes in proportion to the exposed area and the inertia loading changes in proportion to the equivalent volume. Mass and added mass properties also change with equivalent volume. These effects can be investigated by changing the **marine growth thickness** in the INTERMEDIATE DATA INPUT. The program calculates new equivalent diameters and drag coefficients in seconds. It also modifies the leg mass and equivalent added mass and recomputes natural periods and responses.

If wave loading is to be calculated with a new equivalent leg diameter or drag coefficient (in the wave force calculation method used in STA LIFTBOAT it is recommended that the inertia coefficient for each leg is set to 1.5 (ABS, Reference 3), or 2.0 (DnV and Shell, References 1 and 2) then these values must be input at the MAIN DATA INPUT SCREEN (Figure 2), with file LIFTINPT.WR1 loaded, and the wave forces recalculated. Changing the marine growth characteristics in the rig file will not, at this point, cause the program to recalculate the applied loads.

Notice that the equivalent leg diameter is automatically included on the graph of drag coefficient. Comparative leg drag and inertia force sensitivity can be examined for different legs, with different cylinder roughnesses and marine growth thicknesses. Simply multiply the equivalent leg diameter by the maximum drag coefficient to compare drag forces, and multiply the equivalent leg diameter squared by the inertia coefficient (normally 2.0) to compare inertia forces.

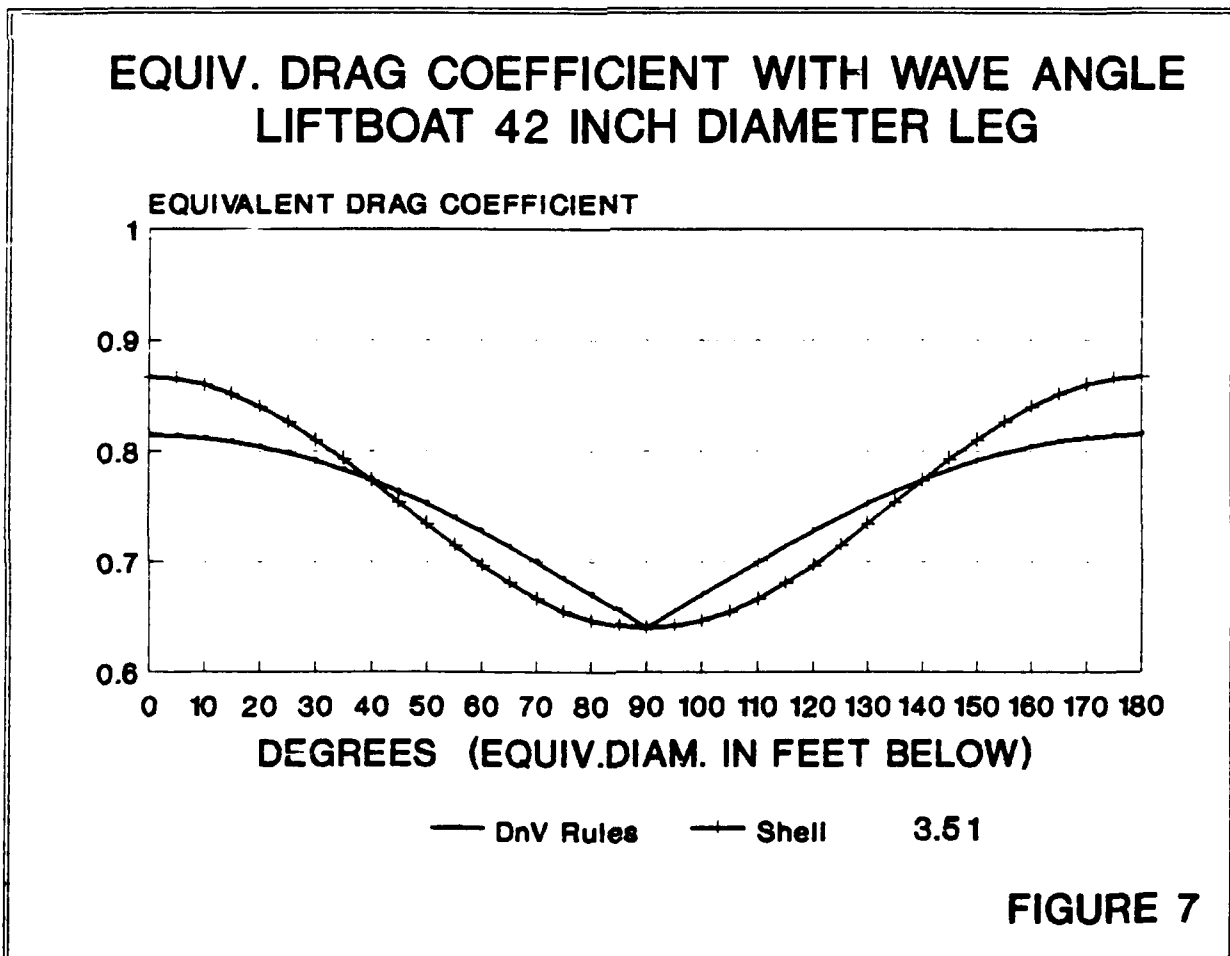

WIND LOADING

The user must supply the following data:

LA	Area of lattice structures (including crane booms if lattice type)
HL	Average height of lattice structures above keel
WB	Length of the hull exposed to beam winds
WH1	Average height of hull and superstructures exposed to beam winds
WL	Width of hull exposed to head winds
WH2	Average height of hull and superstructures exposed to head winds
Avs	Average leg shielding height (usually equal to the hull depth)
AirG	Air gap (from underside of hull to still water surface)
LArm	Lever arm from longitudinal leg center to lateral center of projected hull area
v2	Wind velocity in knots, input v2.

The program finds the components of wind load on each part of the unit, including the legs below the hull, the legs above the hull, the hull and superstructure, and the lattice structures. Height and shape coefficients are used in accordance with ABS Mobile Offshore Drilling Unit Rules, 1988. Proper account is taken for changing projected areas with wind direction, using a generic liftboat hull plan view. Drag coefficients for the legs are as input by the user and will normally have been calculated in the final processing file (note ABS will accept 0.5 for wind drag on cylindrical elements). The length of legs above the hull is calculated by the program from knowledge of the total leg length, the air gap, the water depth, and the pad penetrations.

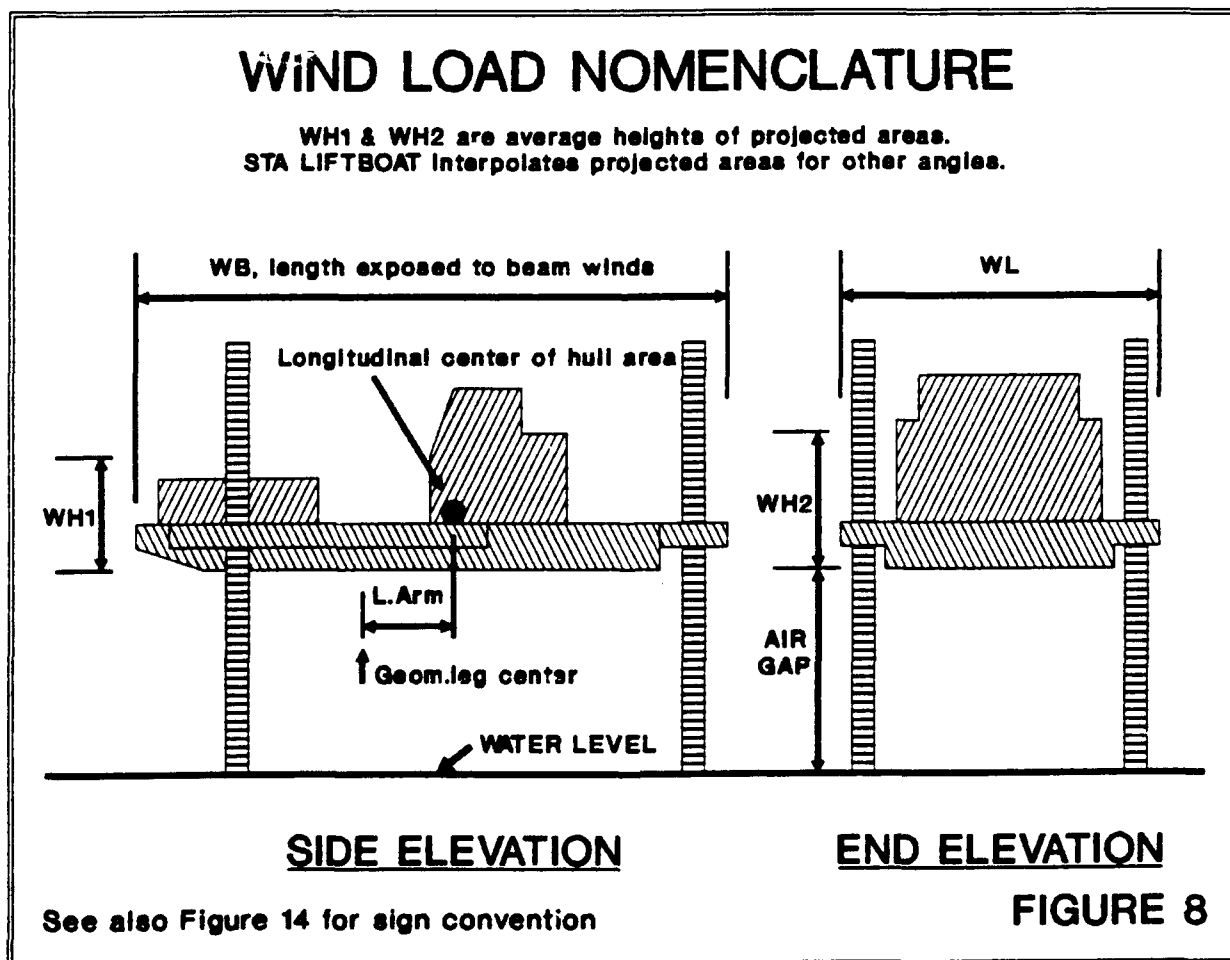

Note that if the boat has a large aft superstructure, relatively large torsional moments may be induced by wind loading, and the term L.Arm should be carefully evaluated (see Figure 8).

If the user has better wind load data, this may be specified as a force acting at an elevation above the mean water level for each run. In this case the input *Wave Force Switch* is set to 1, and program-computed values for wind forces and moments are ignored.

CURRENT PROFILE

A uniform current profile with depth may be specified in the input. Provision has been made for specifying a combination of uniform and wind driven surface current which decays with depth in the next version of STA LIFTBOAT. The combined current velocity at the still water level is used throughout the splash zone. The wind driven current will be set at the surface to 0.017 wind speed, where the wind speed is input value v1, specifically for driving this current (not used in version 1.0). The decay is linear with depth, to zero at 150 feet below the surface. It is permissible to have different values for input wind velocities v1 and v2. The v2 velocity is used only for wind loading, while v1 is used only for current generation. If alternative current profiles are required, these can be supplied by STA by special arrangement. It should be noted that treatment of current velocities in the wave crest may be a strong influence upon response results.

HYDRODYNAMIC LOAD COMPUTATION

STA LIFTBOAT uses a ABS shallow water wave theory as embodied in ABS MODU Rules (Reference 3), Appendix A. This is transparent to the user who need not worry about anything but specifying the leg spacing in the lateral and longitudinal directions, water depth, and wave height.

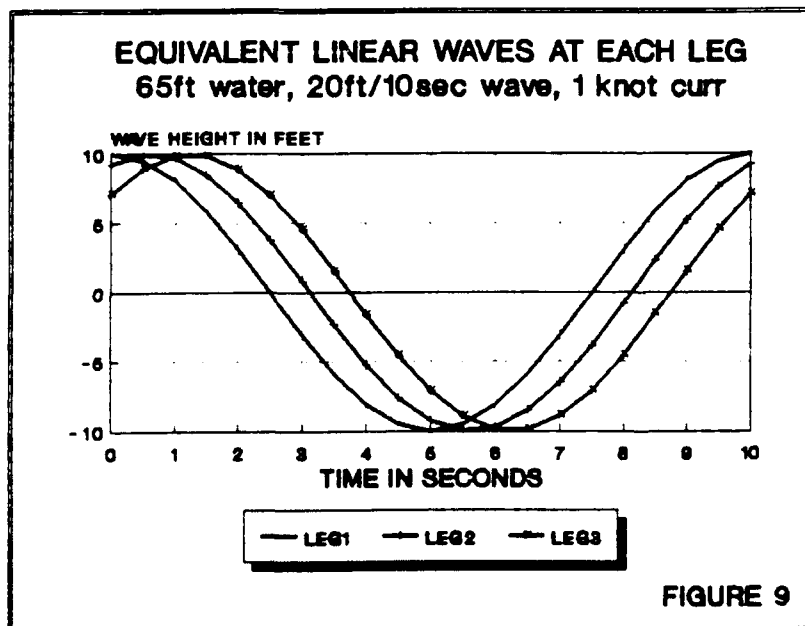

A graph showing the relative wave phasing at each leg during the wave cycle is automatically produced. An example, for the input data given in Figure 2, is shown in Figure 9.

A method to incorporate current, published by DnV (Reference 4) is used. First the inertia force and drag force amplitudes are determined from the ABS method. The Drag force is then approximated by a cosine squared function, and the inertia force by a sine function, maintaining correct phase relationships between the two functions. A drag

load resulting from a uniform current distribution is then separately calculated. The final drag force is approximated to a cosine squared function about a non-zero mean value.

The *maximum* drag force due to the combined action of waves and current is approximately given by:

$$F_D = F_{DW} + 2(F_{DW} \cdot F_{DC})^{1/2} + F_{DC}$$

Where:

F_D = maximum total drag force
 F_{DW} = maximum drag force due to waves
 F_{DC} = maximum drag force due to current

The *mean value* of the total drag force is approximately given by:

$$F_{DM} = 2(R)^{1/2}F_{DW} \quad \text{if } F_{DW} > F_{DC}$$

$$F_{DM} = (1 + R)F_{DW} \quad \text{if } F_{DW} < F_{DC}$$

The *amplitude* of the total drag force is given by:

$$F_{DA} = (1 + R)F_{DW} \quad \text{if } F_{DW} > F_{DC}$$

$$F_{DA} = 2(R)^{1/2}F_{DW} \quad \text{if } F_{DW} < F_{DC}$$

Where:

F_{DM} = mean value of total drag force
 F_{DA} = amplitude of total drag force
 $R = F_{DC}/F_{DW}$

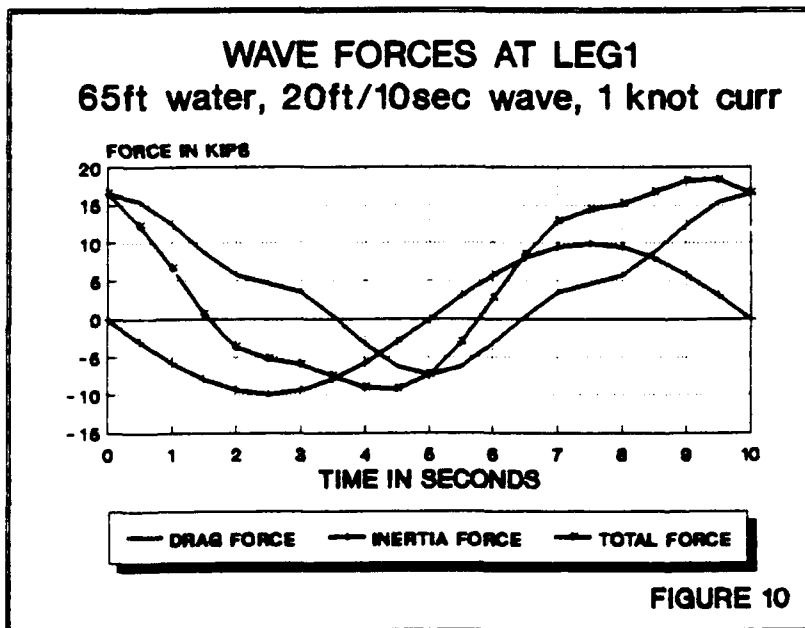

Note also that the user may select any initial phase angle for the run, although 0 degrees is conventional. A phase angle of 0 degrees is represented by the wave crest being coincident with leg 1 at time $t=0$ seconds. A graph of wave loading on leg 1 is automatically produced by STA LIFTBOAT, showing the relative contributions of the drag and inertia forces, as well as the total force acting on the leg during the wave cycle. An example is shown in Figure 10, adjacent. In this figure (as with all figures in this brochure) the starting data is as described in

Figure 2, the MAIN DATA INPUT SCREEN. The principal reason for selecting a non-zero starting phase angle would be to examine the distribution of leg forces at the phase angle corresponding to maximum base shear.

Figure 11, on the next page, shows total forces acting on the boat during a wave cycle. The individual leg forces, with wave and current load, are summed with the wind load on the hull and exposed leg section to give the total load. In this graph (automatically produced for each run) the total horizontal load is labelled base shear. Note that at this stage the loading is being calculated as if the structure was rigid. Spud can reactions are also available at this stage, but are termed "uncorrected" since the response of the structure has not yet been calculated. Rigid body reactions (vertical spud can loads, for example) may be rather non-conservative and should be treated with caution.

Figure 12, below is also produced automatically for each run. It shows the applied overturning moments, with contributions identified from each leg wave and current loading, just as in Figure 11 for applied forces.

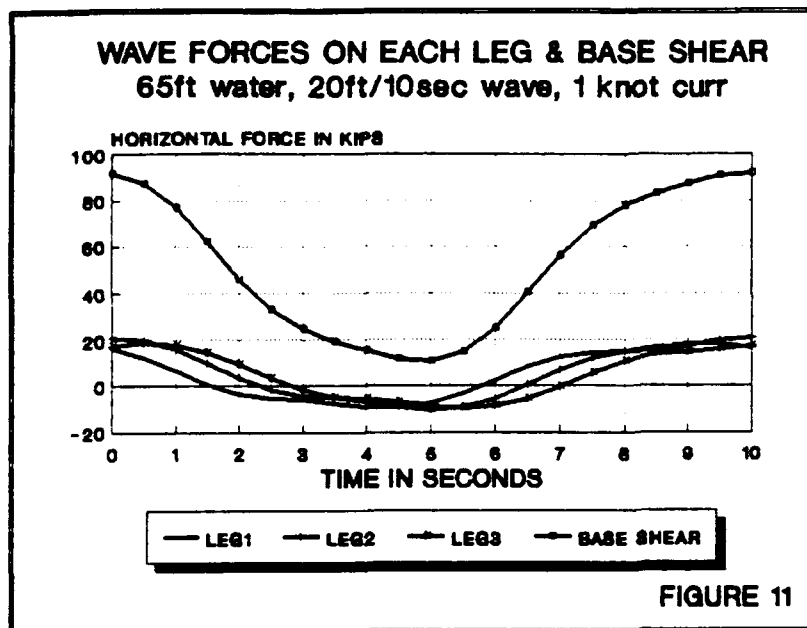

As well as lateral forces and overturning moments, wind and waves may induce significant torsional moments in liftboats. Another applied loading graph, shown in Figure 13, on the next page, is automatically produced for each run and indicates the importance of torsional effects.

The applied loading illustrated in Figures 11, 12, and 13 results from the input data specified in the MAIN DATA INPUT SCREEN, Figure 2. However it is not necessary to print these

graphs for each run since the main data from each graph is contained in summary form in the TABLE OF RESULTS, Figure 4. The appropriate terms from Figure 4 are *maximum wave-current force, mean wave-current force, wind force, maximum total force, amplitude wave-current overturning moment, mean wave-current overturning moment, wind overturning moment, maximum apparent overturning moment, maximum torsional moment.*

While each of these terms is given in the TABLE OF RESULTS, it is often invaluable to see how the terms are varying during a wave cycle, hence the graphs may be consulted (they are instantly available on color on the PC screen) even if they are not printed for inclusion in a report.

It is emphasized, particularly in the case of the overturning moments, that at this stage these are applied, or apparent, forces and moments. Because of sway response the overturning moments are normally greater than the applied moments. Because of dynamic amplification the applied forces and moments may be magnified.

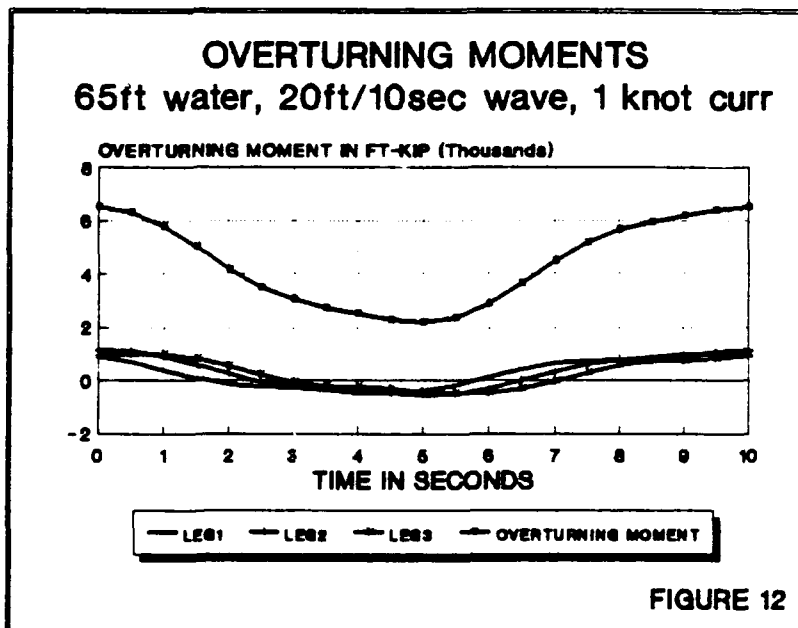

Note also that the location of the center of gravity in the lateral and longitudinal directions will have a large influence on the stabilizing moment and on the induced vertical reactions at the pads.

STRUCTURAL RESPONSE

Having found the environmental loads and their distribution, the next step in evaluating liftboat response is to model the structural characteristics of the system. This is done automatically within the final processing file (loaded after you have pressed Alt-A in the first file then Alt-N in the intermediate file). Details of the most important calculations (and explanation of user input required) are given below.

The user does not have to develop these terms, they are derived by STA LIFTBOAT from the input data given in Figure 3. Note that the STRUCTURAL LEG DATA in this figure is input only once if an existing vessel is being analyzed.

Shear and Bending Stiffness

The shear areas of each leg is taken as the actual cross-section area, A_Q . Area moments of inertia for the two principal axes of each leg are developed. These values are output in the STRESS CHECK INTERMEDIATE RESULTS (see Figure 20). A leg section modulus appropriate for the direction of the applied loading is calculated for each leg (see Figure 8 for individual leg orientation) and an average modulus for the three legs is found. Average values for the x-direction and the y-direction are also found and used to find surge and sway natural periods.

Sea Bed Restraint to Pads, k_s

For extreme load analyses of liftboats, a relatively conservative assumption of pin joints at the pad "tips" has often been assumed. However, the user of STA LIFTBOAT may elect to investigate the effect of soil stiffness providing pad rotational restraint. This is done by specifying an undrained shear strength, s_u , for the soil and a term, G_{factor} , which will yield a soil shear modulus, G , based upon s_u . For small rotations and deep penetrations a factor of 100 for cohesive soils has been suggested by Brekke et al (Reference 5). The program uses the input G_{factor} as follows:

$$G = G_{factor} s_u$$

The program will calculate a value k_s , for a rotational spring representing the spud can-soil restraint at the bottom of the legs. The stiffness, k_s , is based upon the equation for a circular disk, radius r , in an elastic half-space, taking Poisson's ratio, ν , as 0.5:

$$k_s = 8 G r^3 / 3(1-\nu)$$

The user may set k_s equal to zero (pin jointed cans) by either specifying soil undrained shear strength equals zero, or G_{factor} equals zero. In cohesionless soils, the user should use the same terms to select a soil shear modulus, realizing that the undrained shear strength term is now simply a multiplier for specifying G .

Jacking Mechanism Stiffness, k_j

As can be seen in Figure 19, a rotational stiffness at the pinions can be modeled in STA LIFTBOAT. For boats with a single rack jacking system, the program sets the value for Beta to zero and the value for the rotational stiffness of the jack/pinion system is ignored. For double rack systems the user can specify a value for k_j , but should use caution, since the stiffness can only be mobilized for flexure in the plane of the double rack. Consult STEWART TECHNOLOGY ASSOCIATES for guidance.

Bending Moment Coefficients, Beta and Mu

Figure 15 shows the bending moment diagram calculated by the program for each leg. Two coefficients are used, Beta and Mu. Beta determines the fraction of the upper leg bending moment which is reacted by vertical forces in the racks in double rack legs. It is found automatically by the program from the following equation:

$$\text{Beta} = 1/(1 + G A_{Q0} d/k_j)$$

Where G is the shear modulus of steel, A_{Q0} is the average shear area of the leg portion within the guides, d is the vertical distance between the guides, and k_j is the jack stiffness defined above. For leg models where the shear area varies along the leg, the program can be adjusted to automatically select the correct value for A_{Q0} depending upon the leg length extended in the particular run. Consult STA for guidance on this only if legs are not uniform.

Mu determines the bottom leg bending moment and is a function of two other coefficients as shown below:

$$a = A_Q (1 - \text{Beta})/A_{Q0}$$

$$i = I [1 - \text{Beta}(1 - 3b/d + 3(b/d)^2/2)]/I_0$$

Where I is the average moment of inertia of the leg, A_Q is the average shear area of the leg, I_0 is the average moment of inertia of the leg portion within the guides, and d is the height of the jack support point above the lower guides. To get Mu we have:

$$\text{numerator} = 1 + 2id/3I + 2a E I/(I d G A_Q)$$

$$\text{denominator} = 1 + 2E I/(k_s I)$$

$$\text{Mu} = \text{numerator}/\text{denominator}$$

Where I is the leg length from the lower guide to the mid-height of the pad and all other terms are defined above (see also Figure 19).

The transverse overall stiffness of one leg is then given by:

$$k = 1/(f_B + f_Q)$$

Where f_B and f_Q are the bending and shear flexibilities of the leg and are given by:

$$f_B = \text{Beta}^3 [1 - 3\text{Mu}/2(1 + \text{Mu}) + id/I(1 + \text{Mu})]/3EI$$

$$f_Q = I [1 + a/d(1 + \text{Mu})]/GA_Q$$

Alternatively, the overall transverse stiffness of one leg may be represented by:

$$k = 3EI/c^3$$

Where:

$$c = 1 - 3\text{Mu}/2(1 + \text{Mu}) + id/I(1 + \text{Mu}) + 3EI[1 + a/d(1 + \text{Mu})]/I^2GA_Q$$

Euler Leg Load, P_E

STA LIFTBOAT finds the Euler load, P_E , of a leg from:

$$P_E = \pi^2 EI / (K)^2$$

Where K is an effective length factor given by:

$$K = 2 \sqrt{c}$$

Equivalent Linear Damping, η

The user may change the value for η , the equivalent linear damping term. In the absence of better knowledge, a value of η equals 2% critical damping is suggested. From field measurements several years ago (Reference 4) this value has been found to be at the lower (and therefore conservative) end of values for jack-ups, which are expected to behave similarly to liftboats. However, more recent measurements cite a lower value of 1 - 2% critical (Reference 5). STA LIFTBOAT will show results with the user selected value for η , as well as results with twice this value and half this value. Note also that STA LIFTBOAT accounts for the effect of irregular seas when computing response and uses a stochastic DAF as described in DnV Class Note 31.5 (Reference 4).

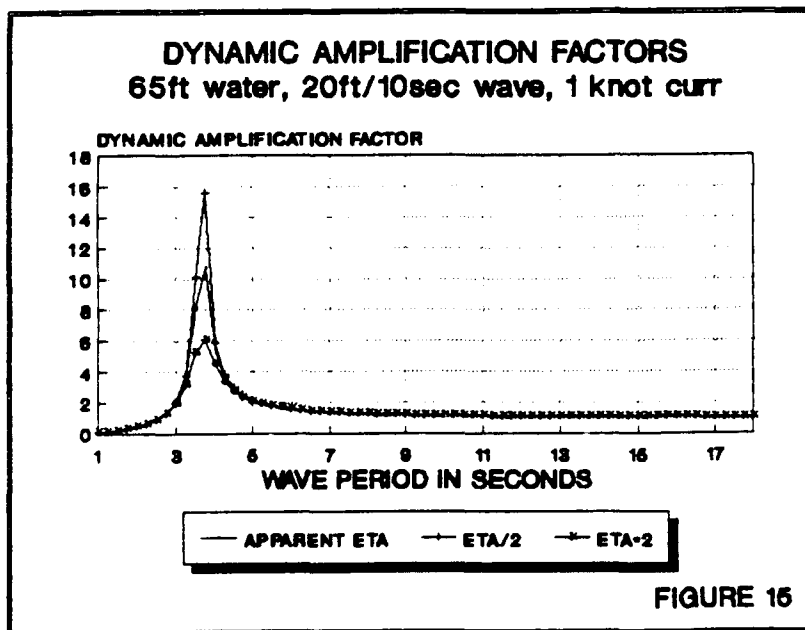

Figure 15, to the left, shows a standard graph produced by STA LIFTBOAT, illustrating DAFs with the three values of η described above.

Calculation of Liftboat Natural Periods

After leg mass and stiffness properties (including hydrodynamic added mass) have been found, the program computes vessel natural periods in surge, sway, and torsion. Full account is taken of the hull inertia and relative position of the center of gravity

position. Values for μ and β both influence natural period results. The closer the natural periods of the vessel get to the wave period, the larger will be the dynamic magnification of the vessel's responses.

The boat's natural periods are given by:

$$T_0 = 2 \pi [m_e / k_e]^{1/2}$$

Where:

k_e = effective stiffness of one leg
 m_e = effective mass related to one leg

For the elevated condition the effective stiffness is taken as:

$$k_e = k (1 - P/P_E)$$

The effective mass for one leg is taken as:

$$m_e = c_1 M_H + c_2 M_L$$

Where:

- M_H = total mass of the hull with all equipment and the portions of the legs located above the lower guides
 M_L = mass of the portion of one leg located between the lower guides and the top of the pads, including hydrodynamic added mass.
 c_1 = $1/n$ for sway modes
 c_1 = $1/n (r_0/r)^2$ for torsion mode
 c_2 = $0.5 - 0.25Mu$
 n = number of legs
 r = distance from center of legs to hull's cg
 r_0 = radius of gyration of the mass M_H with respect to vertical axis through center of gravity

Note that the direction of the applied loading and the relative orientation of the legs and racks may significantly influence the effective stiffness.

Dynamic Amplification Factor (DAF)

The method for calculating the DAFs is conventional, being based upon an equivalent single degree of freedom system. The equation involves the vessel's natural period and the period of the waves, together with the damping value selected.

The dynamic amplification factor is found from:

$$DAF = [(1 - (T_0/T)^2)^2 + (2 \text{Eta } T_0/T)^2]^{-1/2}$$

Where T_0 is the vessel natural period and T is the period of the wave.

The above equation is appropriate to response evaluation in long crested regular waves and may be unreasonably conservative in real sea conditions. To account for this, DnV introduced the concept of a *stochastic dynamic amplification factor*, SDAF. The accepted result of this approach is to compute DAFs with twice the equivalent linear damping term, Eta. This method is also adopted in STA LIFTBOAT, where input Eta values are doubled in order to find reasonable DAFs. If the user wishes to evaluate response in long crested regular waves, a value of only one half of the desired damping coefficient should be input.

Damping alone limits vessel response values at resonance, where the wave period and the vessel first natural period are coincident. Away from resonance, as is the normal case with storm waves, the damping value is less critical. However, because of the uncertainty in the damping value, the program also shows the (stochastic) DAFs that result for values of one half the selected Eta and for twice the selected Eta. The actual DAF used to calculate response amplification is that for the selected value of Eta at the selected wave period (with the stiffness appropriate for the selected direction). The user can judge from the DAF curves if the selection of a different Eta value would have a strong influence on the DAF. If this is the case, it is advisable to try a different value for Eta and repeat the analysis. This takes only a few minutes.

DYNAMIC RESPONSE ANALYSIS

Having found the environmental loading, the program applies this loading to the structural model and finds deflections. The loading is divided into a mean, or steady part, and an amplitude, or dynamic part. The response is found from the combination of static response to the steady loading and dynamic response to the dynamic loading. The dynamic response is found from multiplying the equivalent static response to the amplitude of the dynamic forces, multiplied by the DAF found above.

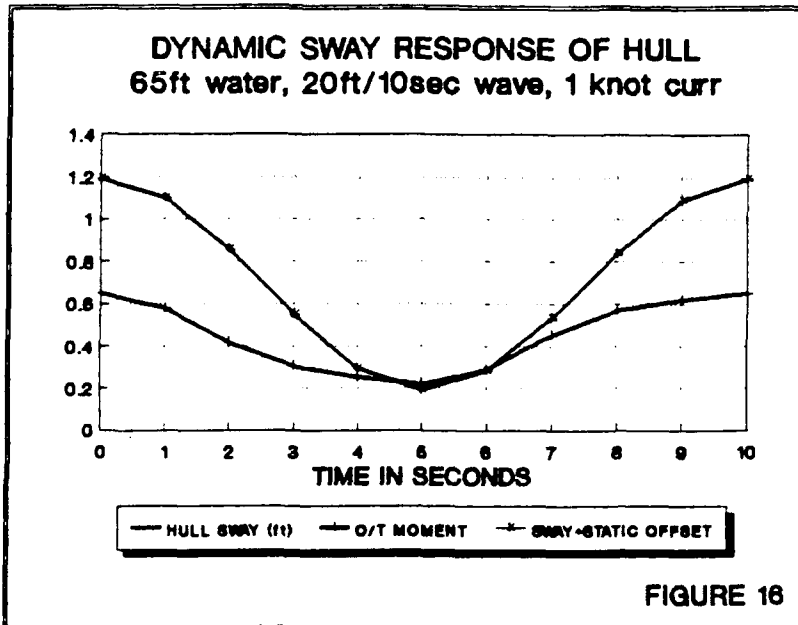

Where the DAF is small, the total response is approximately the same as would have been found by static analysis alone. Where the DAF is large, there may be significant differences.

Figure 16 shows the hull sway response of the liftboat, with and without the effect of static offset. Input conditions are defined in Figures 2 and 3. As the horizontal offset coefficient was set to zero, the two response curves are superimposed on each other. This is another example of a graph which is

produced automatically each time the program is run, although it may not always be printed.

It is important to note that the response and the forcing function (the dynamic component of the wave-current forces) are not necessarily in phase. The phase lag of the response may result in the maximum deflection occurring after the maximum overturning moment. Hence the maximum additional overturning moment caused by the lateral deflection of the center of gravity of the boat is not normally added directly to the overturning moment in order to determine the maximum overturning with the P-Delta effect.

The overturning moment (uncorrected) is also plotted above, in Figure 16, in order to show its general form. If this forcing function is very non-sinusoidal there may be reason to suspect that the dynamic response is over-estimated. However, experience shows that the overturning moment is normally close to having a sinusoidal variation and there should be few instances where the dynamic results are overly conservative.

The applied, or **uncorrected**, overturning moment and the actual, or **corrected**, overturning moment felt by the structure, including dynamic effects and the P-Delta effect, are shown together in Figure 17, on the next page. It is important to note that the maximum value of the corrected overturning moment may be significantly greater than the maximum value of the uncorrected moment. In the example shown in Figure 17, around 20% increase in the overturning moment can be seen when the corrected value is compared with the uncorrected value.

Similar changes in soil reactions under the pads are discussed in the next section.

FOOTING REACTIONS

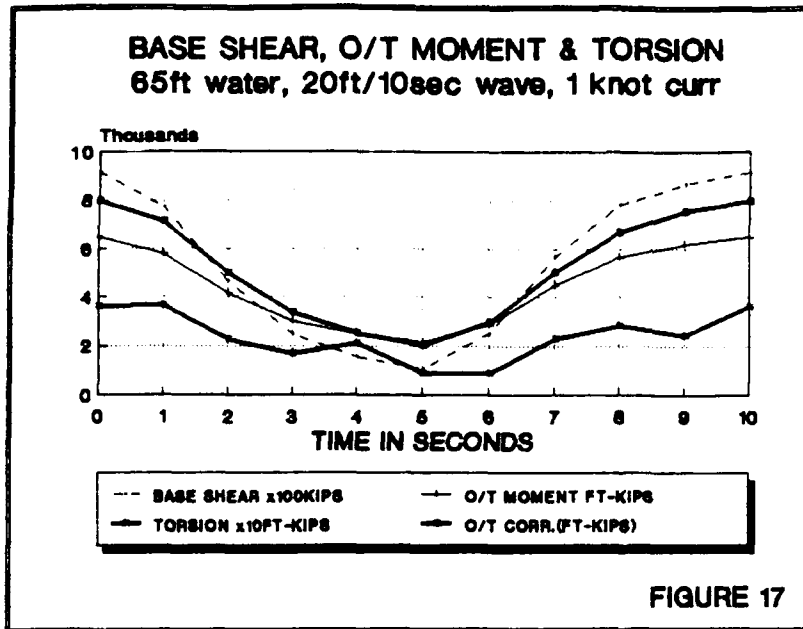

A common limitation of liftboat operability in a given location is footing preload level. The soil beneath the pads of liftboats must be preloaded to a level that should not be exceeded during elevated operations, including conditions of severe storms, when every attempt must be made to bring the center of gravity close to the geometric leg center. In fact it is a displacement consideration that must be satisfied, since some additional vertical penetration may be tolerable, the question is "How much?"

Figure 18, below shows the variation in footing reactions during the passage of the wave.

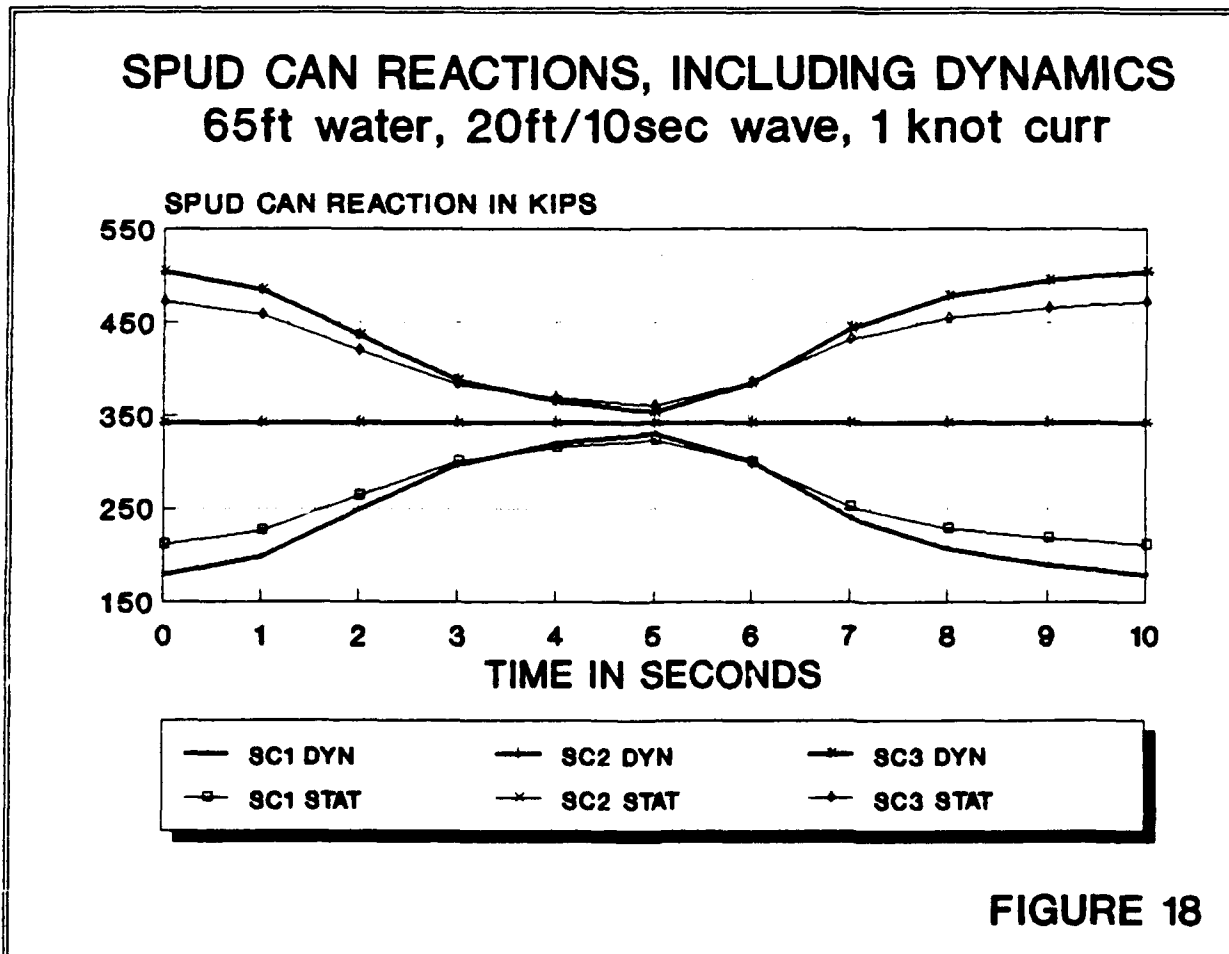

The maximum and minimum spud can reactions are tabulated in the TABLE OF RESULTS (Figure 4). Note that both *uncorrected* and *corrected* values are given in this table. Both values are shown in Figure 18 on the previous page. The effect of platform sway, or the so-called P-delta effect which results from platform sway response, can be clearly seen. This sway response moves the boat's center of gravity laterally and creates greater loads on the down-environment leg(s) and reduced loads on the up-environment leg(s). The same effect also changes the effective, or apparent, overturning moments shown in Figure 17. *Corrected* spud can loads and overturning moments are found after platform structural response has been calculated, both statically and dynamically.

The general form of the shear force and bending moment diagrams is shown in Figure 19, below.

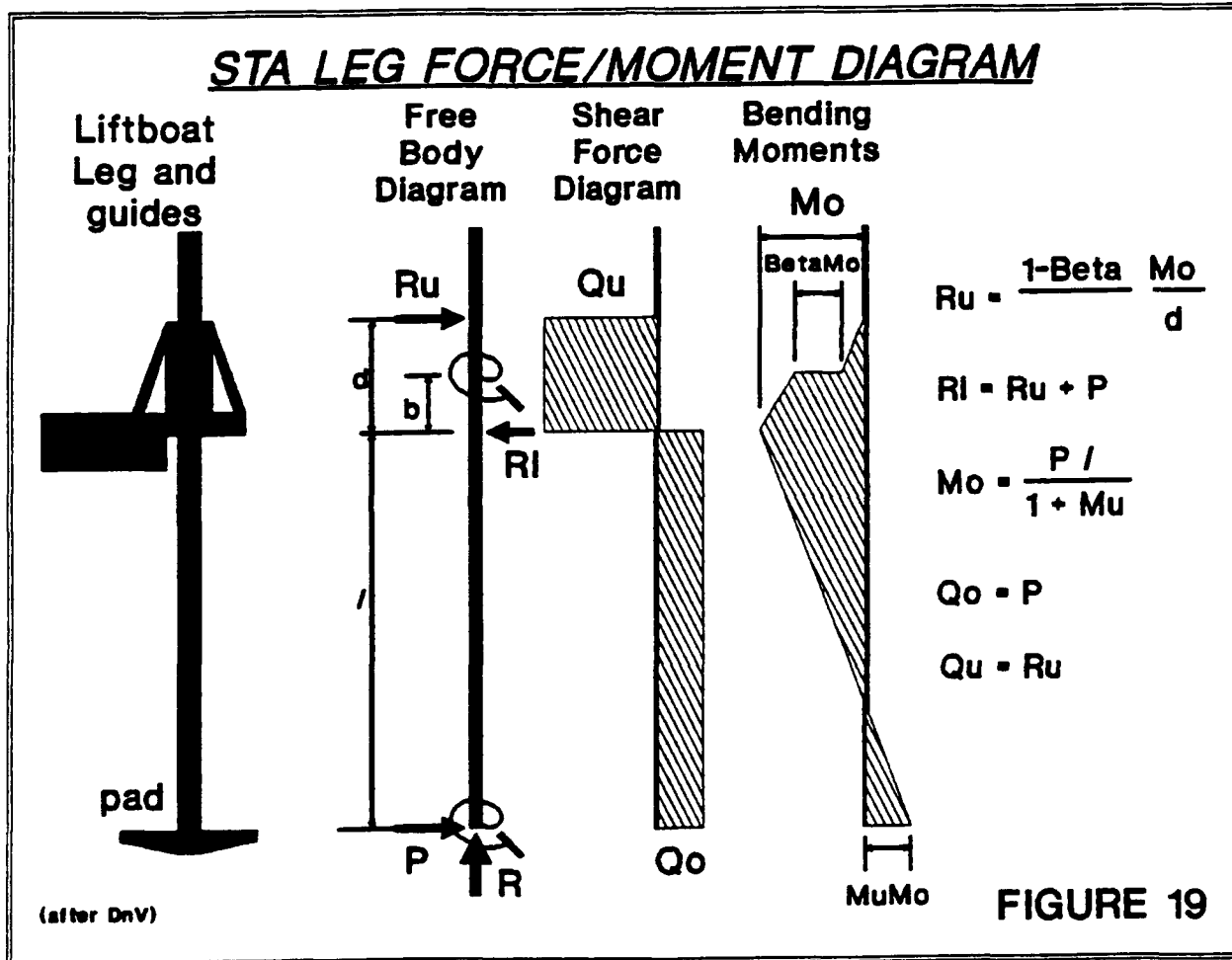

In fact the wave and current loads are applied down the leg so the shear force is not constant along the legs beneath the hull. The main simplifying assumption made in STA LIFTBOAT is that the three horizontal components of footing reaction are equal. Comparison of the program with a full finite element analysis Reference 6) has shown this to be a reasonable assumption in design wave conditions. It was found to cause errors in the critical leg stresses of less than 5%, and errors in lateral response of less than 3%.

It should be noted that because of the upper fixity of the legs in the guides, if the soil is modeled as a pin-joint, the effective length factor for the legs will exceed 2.0. More is given on this under the section on stress checks.

CORRECTED STABILIZING MOMENT (DnV)

Instead of accounting for the vessel response increasing the overturning moment and reducing the factor of safety against overturning, DnV reduce the stabilizing moment before calculating an overturning safety factor.

The minimum static stabilizing moment, found from boat weight multiplied by distance to the centerline of the nearest pair of legs, can be reduced by a factor which accounts for secondary leg bending effects. This approach is fully explained in Reference 4. The DnV reduction factor is a function of the maximum deflection of the hull (center of gravity) the average axial leg loads, and the Euler buckling loads of the legs. The reduced stabilizing moment is tabulated in the TABLE OF RESULTS (Figure 4) determined from the formula below:

$$M_S = M_{S0} - n P (e_0 + e)/(1 - P/P_E)$$

Where:

- M_{S0} = stabilizing moment as calculated if the legs are perfectly straight and vertical
- n = number of legs
- e_0 = maximum static horizontal offset of platform in absence of environmental loads
- e = maximum horizontal deflection of platform caused by static and dynamic effects of wind wave and current
- P = average axial leg load
- P_E = Euler load of one leg

Note that e_0 is calculated by the program using K_e0 (Figure 3) the leg out of straightness coefficient. The term K_e0 is multiplied by the leg length extended to give a static offset of the hull accounting for leg out of straightness, hull/leg clearances, and a slight heel of the platform. DnV recommend a minimum value of 0.005 for the coefficient, while Shell, for North Sea jack-ups, now require 0.003 (Reference 2)

The value of e is made up from the *mean hull deflection* plus the *hull deflection amplitude*, which is where the DAF is used. The mean hull deflection is determined statically. In the TABLE OF RESULTS, the *maximum hull deflection* is e , and the term *Offset plus deflection* is $(e + e_0)$. If the user does not wish to consider the static offset associated with leg out of straightness, simply set K_e0 to zero.

The Safety Factors against overturning are reported for both approaches in the TABLE OF RESULTS. The **corrected** overturning safety factor is the result of dividing the uncorrected stabilizing moment by the maximum overturning moment including dynamics and the P-Delta effect. The DnV safety factor is the result of dividing the corrected stabilizing moment by the maximum overturning moment including dynamics but NOT the P-Delta effect. The results of the two methods are often similar. However because of the response phase lag, the **corrected** overturning safety factor is sometimes larger than the DnV safety factor.

LEG STRESS CHECKS

STA LIFTBOAT performs stress checks according to ABS requirements (Reference 3) and in accordance with recommendations made to the US Coast Guard (Reference 6). These stress checks are performed for the leg steel at the critical location of the lower guide, where bending moments are maximized. The maximum axial, bending and shear stresses in each leg at this location are determined for each leg. The stresses are derived from the calculated forces and moments (which are reported in the TABLE OF RESULTS) together with the leg section properties. Note that the program calculates leg section properties appropriate to the direction of applied load for each leg. An example of the STRESS CHECK output is given in Figure 20 on the next page.

STA LIFTBOAT v1.01 December 1990

STRESS CHECK INTERMEDIATE RESULTS				07/30/91 Date of this run	
Rig Name: STA LIFT1				Geometry Switch Selected - 1	
Run Pat: 69L 20/10/2 Limiting Preload, Flooded Legs					
Leg Area Moments of Inertia					
Leg #	1 (port)	2 (stern)	3 (stbd)	Leg cross section area (sqin) ---->>>> 123.55	
ixx	1.1531	1.3582	1.1531	for-ast bending direction (ft4)	
yyy	1.3582	1.1531	1.3582	lateral bending direction (ft4)	
Column Buckling Stresses Legs are fully flooded					
For definition of K-equivalent see manual			K = 2 for stress check		K-equiv
K-equiv	2.00		71.25	(F _{2y} /4PI ² E)(K/r) ²	71.25
K/r	151.82	(with K = 2)	12.63	PI ² E/(K/r) ²	12.63
K/r	151.82	(with K-equiv.)	42	leg diameter, D (in)	151.82
sqr.in.	98.61	[SQRT(2PIIE/Fy)]	0.875	leg wall thickness, t	98.51
Fcr	12.63	ksi (critical overall buckling stress, ABS)			12.63
F.S.	1.44	(combined loads)	60	yield stress for leg (ksi)	1.44
D/t	47.00	ratio	(D/t).25= 2.62	(D/t to power .25)	47.00
E/Fy	54.63	ratio	4248000	Young's modulus for leg (ksi)	54.63
Is D/t > E/Fy? No, hence no local buckling check required by ABS.					
Allowable Axial Compressive Stresses					K-equiv
0.12E/R	147.50	ksi (Younger)			147.50
2CE/D	368.75	ksi (F _{xe} , elastic local buckling str: API with C = 0.3)			368.75
Fxc	60.00	ksi (inelastic local buckling stress: API)			60.00
Faa	48.00	ksi (ABS allowable axial stress 1), Para: 3.11.4)			48.00
Fab	8.77	ksi (ABS allowable axial stress 2), Para: 3.11.4)			8.77
Fac	48.00	ksi (ABS allowable axial stress 3), Para: 3.11.4)			48.00
Fa	8.77	ksi (min.val.of above 3; ABS allow. axial comp.str.)			8.77
Fb	48.00	ksi (ABS allowable comp.str.due to bending)			48.00
fa/Fa 1,3	0.37	<<<using K = 2	using K-equiv>>>		0.37
fb/Fb 1,3	0.58	<<<using K = 2	using K-equiv>>>		0.58
fa/Fa 2	0.28	<<<using K = 2	using K-equiv>>>		0.28
fb/Fb 2	0.66	<<<using K = 2	using K-equiv>>>		0.66
Is fa/Fa > 0.15? Yes, hence use 2nd ABS unity check.					
Unity Checks at Lower Guide for Each Leg					
1st ABS Unity Check			2nd ABS Unity Check		
K = 2	K-equiv.	0.85 C _m coefficient	K = 2	K-equiv.	
0.95	0.95	legs 1 and 3 (fwd legs)	1.14	1.14	
0.94	0.94	leg 2 (stern)	1.06	1.06	
8.79	8.79	ksi, F _e , ABS Euler str. * 4/3			
New Unity Check at "member ends" (lower guide) for combined and static loadings					
0.65	combined: legs 1 and 3 (fwd legs)		0.09	static: legs 1 & 3	
0.71	combined: leg 2 (stern)		0.07	static: leg 2	
DnV Usage Factor Calculations					
31.04	sigmax, axial stress legs 1, 3		59.69	sigmacr, critical stress legs 1, 3	
33.93	sigmax, axial stress leg 2		59.74	sigmacr, critical stress leg 2	
31.20	sigmas, von Mises equiv. legs 1, 2		0.85	DnV unity check Legs 1, 3	
34.08	sigmas, von Mises equiv. leg 2		0.87	DnV unity check Leg 2	

STRESS CHECK OUTPUT EXAMPLE
FIGURE 20

The above figure shows the additional tabular output automatically produced by STA LIFTBOAT for each run. The first information shows the user the date of the run, the name given in the MAIN DATA INPUT screen (Figure 2) for the boat, the type of leg rack geometry selected (1, 2, or 3, see Figure 6) and the name given to the run, which appears as the second title on most of the graphs. The next block of information shows the cross sectional area of the leg and the global area moments of inertia in the x- and y-directions. These data have been generated by the program based upon the INPUT STRUCTURAL LEG DATA given in Figure 3 (see also Figure 5). If these values are not what you expected check your input data (Figure 3) and check that you have selected the correct geometry switch and rack switch (1 or 2).

FURTHER DESCRIPTION OF STRESS CHECKS

K-Factors

The block of output data titled **Column Buckling Stresses** in Figure 20 shows nomenclature which follows Section 3.11 in the ABS Rules (Reference 3). As a convenience for the user, parameters leading to allowable stresses, as well as allowable stresses, are developed using $K = 2.0$ and K-equivalent. K is an effective length factor which accounts for the support conditions at the ends of axially loaded members. Using $K=2.0$ may satisfy certain stress checking requirements, but the actual value of K found by the program (called K-equivalent) should not be greater than 2.0 if 2.0 is to be used in stress checking. The actual value of K will be greater than 2.0 for liftboats when no soil stiffness is modelled beneath the pads, as the separation of the upper guides permits leg flexure between the guides.

Effect of Stiff Soil

When a very stiff soil is modeled beneath the pads, the actual value of K (reported as K-equivalent) may approach 1.0. (for most liftboats 1.1 is a limiting value as a consequence of the separation of the upper guides). Under these circumstances the value of μ will be greater than 1.0 (see Figure 19) and the maximum stresses will be induced in the legs at the connection with the pads. STA LIFTBOAT reports the bending moment in the leg at the pad without the P-delta effect. The program also reports the maximum bending moment in the leg induced by the P-delta effect, as well as maximum vertical reactions at the pads. With these forces and moments a check on maximum stresses in the leg at the pad can easily be made.

Allowable Axial and Bending Stresses

Local buckling stresses are derived from API formulae (Reference 7). An elastic and an inelastic local buckling stress are reported, both of which are primarily functions of the D/t ratio for the cylindrical leg, ignoring the stiffeners and stiffening effect of the rack(s).

The three possible limiting allowable axial compressive stresses, according to ABS Rules are reported. The overall buckling stress, divided by the appropriate factor of safety, will be largest for the smallest value of K. This is often the controlling allowable axial stress value.

The actual axial stresses reported are the maximum for the forward leg pair and the maximum for the aft leg, providing for the potential of different resistances for these legs caused by the different local orientation of their principal axes. Note that the maximum bending stress is derived for a maximum fiber distance from the neutral axis corresponding to the outer diameter of the cylindrical leg. A check should be made on the rack bending stress at the tooth root if the rack steel is not of a significantly higher yield strength than the leg steel.

Stress Ratios

Ratios of actual divided by allowable axial stress and bending stress are shown in Figure 20 for the maximum of the forward legs, and for the aft leg. Two sets of stress ratios are shown, one using $K=2.0$ in the calculation for allowable axial stress, and the other using the actual computed value for K (K-equivalent, which will vary with the selection of soil parameters for a given rig design).

Unity Checks

A total of six ABS unity check results are given for each leg type (legs 1 and 3, or leg 2). All unity checks are for the legs at the level of the lower guide where the stresses are highest. Two unity checks are made with $K=2.0$ and two are made with K -equivalent for each leg type under conditions of combined axial and bending stresses. The results of the highest unity check usually govern, but the program notes if the second ABS unity check is required (if f_a/F_a is greater than 0.15).

The last two unity checks for each leg type are required by the ABS as from May 1989, and relate to "ends of members". The combined loadings case may occasionally govern.

SPECIAL FEATURES

Most of the features of STA LIFTBOAT have been described in the previous text. There are several special feature which merit further description.

Flooded Legs

In most cases liftboats are designed to have dry legs. These legs provide buoyancy which is calculated by STA LIFTBOAT. It may be useful to compare the elevated performance of a boat with dry legs to the same boat with flooded legs. The flooded legs increase the stabilizing moment, increase the effective mass, increase the sway periods, and hence may increase dynamic amplification of wave loads. However, the net change to vessel performance may be found beneficial.

In the MAIN DATA INPUT SCREEN, a term **leg buoyancy coefficient** may be set to 1 if the legs are dry, or to 0 if the legs are flooded. Nothing else needs to be changed in order to compare performances of the same vessel. The extra mass of the water inside the leg will change the leg weight, hence vertical pad reactions, and will change the natural periods, hence DAFs. The first line of the RESULTS SUMMARY indicates the buoyancy option selected with one of three messages: *Legs are dry internally; Legs are fully flooded; or, Legs are partially flooded*. The average leg buoyancy and pad loads on the sea bed before environmental loading are also displayed.

Switching Off Dynamics

Dynamic responses usually constitute a major part of liftboat response. However, these dynamic responses are difficult to isolate, especially because of the P-delta effect. In the INTERMEDIATE DATA INPUT SCREEN, a term **natural period multiplier** may be set to 1 if correct dynamics are to be included. If dynamics are to be switched off, set this term to a small number, such as 0.01, and the DAF will be set to zero. Note that too small a number may cause an error to appear and for several output terms to be labeled "ERR".

Added Mass Coefficient

In the INTERMEDIATE DATA INPUT SCREEN, the **added mass coefficient** should normally be set to 1.0. Any other value may be selected and the added mass associated with the submerged portions of each leg will be multiplied by this coefficient. An example of when this may be useful is to examine the change in dynamics without re-running wave loading (added mass affects natural frequencies).

RESULTS SUMMARY

A brief definition of each term in the TABLE OF RESULTS is provided on the next few pages.

Pad1 bef.env.loads

Foundation pad on leg 1, vertical reaction as a consequence of boat weight and weight distribution only. Does not include the contribution from offset caused by hull not being level, legs not being vertical, etc.

Pad1 bef.env.loads

Pad on leg 2, vertical reaction as defined for SC1, above.

SC3 bef.env.loads

Pad on leg 3, vertical reaction as defined for SC1, above.

Weight-buoyancy

Total boat weight less buoyancy on legs. Pads are assumed to be flooded (or filled with a ballast material that has been accounted for in the total weight input) such that the buoyancy of the cans need not be considered. This is the total vertical reaction applied by the seabed to the pads.

Av.leg buoyancy

Leg displacement multiplied by weight density of sea water. Leg equivalent average diameter squared times $\pi/4$, multiplied by {water depth + pad penetration} multiplied by 0.064 kips/cuft

Total buoyancy

Sum of all three leg buoyancies.

Lateral Stiffness

The equivalent lateral stiffness of the hull, as if it were constrained only by a horizontal spring. This term accounts for the rotational stiffness of the soil/pads, the leg axial, flexural, and shear stiffnesses, and the leg/hull connection. It is strongly affected by the leg length extended. It includes a reduction factor which is a function of the Euler buckling load for an individual leg. It is in the direction of the applied loading.

Lateral x-stiffness

As above but for the fore-aft direction.

Lateral y-stiffness

As above but for the transverse direction.

Wind Force

If this result appears as "DEFINED ABOVE" then the user has set the WIND FORCE SWITCH to 1 on the original input screen and has specified a wind force to be used and its center of action. If a value in kips appears, then the input above, will show "COMPUTED BELOW" and the value will correspond to the wind force calculated by the program. This calculated value is described in the manual and takes account of a wind velocity profile, as well as the exposed area of legs and hull at the attack angle selected by the user.

Mean wav-cur.force

The total mean horizontal force on the three legs from water particle velocities and accelerations, calculated at 20 phase angles during the wave cycle, properly accounting for the spatial position of each leg. Even without current, this value is usually positive, as the wave loading as the crest passes a leg is greater than that as a trough passes. In short waves, force cancellation effects on the legs may be important. View the graphs of wave forces on each leg to see if this is the case.

Max wav-cur.force

The maximum total horizontal force on the three legs, defined in the same way as the mean force, above.

Max. total force

The sum of the maximum horizontal wave-current force on the legs and wind force on the hull and legs above the water surface.

Wind O/T moment

The wind force multiplied by the lever arm from its center of action to the pad tips.

Mean wav-cur O/Tm

The mean value of the water particle elemental loads on each leg, multiplied by the elevation of each elemental force above the pad tips, causing an overturning moment.

Amp.wav/cur.O/Tm

Amplitude of the wave-current induced overturning moment calculated as described above.

Max.apparent O/Tm

Maximum overturning moment from wind, waves, and current, described as "apparent" as the response of the boat is not calculated at this point. If the boat was rigid and did not deflect at all, this apparent overturning moment and the actual maximum overturning moment would be the same.

Trux sway period

Natural sway period in the longitudinal direction. The period is calculated accounting for the specified soil conditions, leg flooding condition, etc., etc.

Tryy sway period

Natural sway period in the lateral direction.

Max torsion mom.

The maximum apparent torsional moment, defined as for the maximum apparent overturning moment above.

Nat. tor. period

The natural torsional period of the boat. Comments as for the sway period, above, apply.

DAF

Dynamic Amplification Factor, calculated as described in the manual, using a stochastic damping term equal to twice the user-specified percentage-critical damping. This is the ratio of the dynamic response amplitude compared to the static response amplitude to a given load applied at the wave frequency. Use a natural period for the calculated wave direction which will lie between Trux and Tryy.

Mean hull defn.

This is the lateral deflection of the hull caused by the mean wind and water loads. It is calculated statically and does not include the effect of the hull being out of level or the legs not being vertical.

Hull defn. amp.

Dynamically calculated lateral hull deflection in response to the amplitude of horizontal water forces.

Max hull defn. *

The sum of the above two terms, mean hull deflection and the amplitude of hull deflection. It does not include the effect of initial offset.

Offset+defn **

The above term, maximum hull deflection, plus an initial offset as a consequence of imperfections, including the legs not being perfectly vertical and the hull not being perfectly level, etc. This initial offset is found from an offset coefficient, Ke0 (see INTERMEDIATE DATA INPUT SCREEN) and the leg length extended beneath the lower guides.

Uncorr.stab.mom.

The "uncorrected" stabilizing moment, calculated from the weight of the unit multiplied by the lateral distance from the center of gravity to the center line of the nearest pair of legs. The distance is calculated with the structure in the undeflected position.

Euler leg load

Euler buckling load of one leg, calculated as described in the manual, with due account for foundation and hull fixity to leg.

Corr.stab.mom.

"Corrected" stabilizing moment, calculated according to a formula from DnV, as described in the manual. This includes a reduction term involving the Euler buckling load, the offset plus deflection and the average axial leg load.

Max. base shear

Total maximum base horizontal reaction force, accounting for static (mean wave-current and wind) and dynamically amplified forces. Note that this reaction force may be less than, or greater than, the applied wind and wave loads, depending upon the ratio of natural sway period to applied wave period.

Max.Up.guide reac.

The maximum horizontal reaction at the upper leg guide on one leg, including static and dynamic contributions.

Max.Low.gde.reac.

The maximum horizontal reaction at the lower leg guide on one leg, including static and dynamic contributions.

Max.equiv.top load

The equivalent horizontal load which, if applied at the level of the hull, would result in a lateral deflection equal to the maximum (static plus dynamic) deflection calculated from actual load distribution. This term is simply the maximum lateral deflection, not including static offset, multiplied by the lateral stiffness.

Max.horiz.SC.reac.

One third of the maximum horizontal reaction force. The assumption of one third of the total force being reacted by each pad is reasonable in long waves and in situations with significant dynamic contributions to total response.

BM.pad.max.w/o.PD.

Maximum bending moment induced in the leg just above the pad, including both static and dynamic loading, but before adding any contribution from the P-Delta effect.

BM.hull.max.w/oPD

Maximum bending moment induced in a leg at the level of the lower guide, including both static and dynamic loading, but before adding in the contribution from the P-Delta effect.

PDelta leg BM.max

Maximum bending moment induced in a leg as a consequence of the P-Delta effect. This is the product of the maximum pad vertical reaction during the wave cycle multiplied by the maximum deflection.

BM.hull.max.w.PD

Maximum bending moment induced in a leg at the level of the lower guide as a consequence of the P-Delta effect plus the maximum moment defined above.

PadMax.Id.uncorrtd.

Maximum pad vertical reaction during wave cycle in response to self-weight and environmental loads, calculated as if the structure remained static with legs perfectly vertical.

PadMin.Id.uncorrtd.

Minimum pad vertical reaction during wave cycle, as defined for max pad load, above.

PadMax.Id.corrected

Maximum pad vertical reaction during wave cycle, calculated to include the P-Delta effect as well as dynamic response. Note that the P-Delta effect (the lateral movement of the center of gravity) will always increase maximum vertical reactions over the "uncorrected" values, while the effect of the dynamic analysis may be to decrease the reactions in very short period (relative to the natural sway period) waves. In waves around the natural sway period, dynamic response will always be greater than static values.

PadMin.Id.corrected

Minimum pad vertical reaction during wave cycle, including P-Delta effect, static, and all dynamics as described for maximum pad reactions.

Pad mean angle

Mean angle of rotation of pad (assumed rigid) during wave cycle. This angle is a function of the soil stiffness, leg stiffness, pad dimensions, static and dynamic loading.

Pad max.angle

Maximum angle of pad during wave cycle, not including P-Delta effect (which is normally expected to be a small influence on this term) and not directly including initial offset.

MaxOT w/o PDelta

Maximum overturning moment calculated to include both static and dynamic effects, but not including the P-Delta effect.

Max.OT.mom.w.PD

Maximum overturning moment as above, but also including so-called P-Delta effect of additional moment resulting from lateral deflection of the center of gravity relative to the pad vertical reactions.

Static Offset

Lateral deflection, in inches, of hull as a consequence of the user specifying an offset coefficient (which is multiplied by leg length extended to give this offset) in the INTERMEDIATE DATA INPUT.

Max.hull ax.F1,F3

Maximum axial load in either leg 1 or leg 3 (the forward legs) at the level of the lower guide.

Max.hull ax.F2

Maximum axial load in leg 2 (stern leg) at the level of the lower guide.

K-Equivalent

Calculated effective length factor based upon the spacing of the upper guides and the soil/pad conditions specified.

max fb, legs 1,3

Maximum bending stress induced in either leg 1 or 3 at the level of the lower guide. Stress is calculated based on maximum bending moment, leg area moment of inertia appropriate to loading direction, and a distance from the neutral axis equal to half the OD of the leg.

max fb top leg 2

Maximum bending stress as above, but for leg 2.

Uncorr.O/T SF

Overturning moment resulting from application of wind and wave-current forces applied statically to the perfectly vertical structure. This is the maximum uncorrected stabilizing moment divided by the apparent overturning moment.

Corrected O/T SF

"Uncorrected" stabilizing moment divided by the maximum overturning moment, including dynamics and P-Delta effect.

DnV O/T Safety F.

Overturning moment resulting from dividing the "corrected" stabilizing moment (R14) by the maximum overturning moment including dynamics, but not the P-Delta effect.

max fa, legs 1,3

Maximum axial stress induced in either of legs 1 or 3 at the level of the lower guide.

max fa, top leg 2

Maximum axial stress induced in leg 2 at the level of the lower guide.

K=2 Unity chk.legs 1,3

ABS combined axial and bending stress unity check for the worst case of either leg 1 or leg 3 at the level of the lower guide. Although the hull deflections and leg stresses are calculated with the specified end conditions (and the K factor that results from these end conditions) the stress check is performed with $K=2.0$.

Hull max.shr.str.

The maximum shear stress in any leg calculated at the level of the lower guide.

K=2 Unity chk.leg 2

ABS combined axial and bending stress unity check as defined above for legs 1 and 3.

K-equiv.Un.chk.legs 1,3

ABS combined axial and bending stress unity check at the level of the lower guide for the worst case of either leg 1 or 3. The value of K, the effective length factor used in the unity check is the same as that which results from the end conditions for the legs modeled in the analysis.

K-equiv.Un.chk.leg 2

ABS unity check at the level of the lower guide for leg 2, with the value of K defined immediately above.

fa/Fa ABS leg 2

This term may be for leg 2 or for legs 1, 3. The term printed depends on which legs have the highest unity check. fa/Fa is the ratio of maximum calculated axial stress at the level of the lower guide to allowable axial stress.

fb/Fb ABS leg 2

This term may be for leg 2 or for legs 1, 3. The term printed depends on which legs have the highest unity check. fb/Fb is the ratio of maximum calculated bending stress at the level of the lower guide to the allowable bending stress.

PRINTING

STA LIFTBOAT is designed to print reports using the Lotus Corporation ALWAYS spreadsheet publishing add-in program. This program comes with the latest versions of Lotus SYMPHONY and Lotus 1-2-3. All the user has to do to print standard reports is to follow the instructions on the two DATA INPUT SCREENS (Figures 2 and 3). Note that Figures 2, 3, 4, and 20 in this document are output direct from STA LIFTBOAT. They have not been re-touched in any way for inclusion in this document.

As noted on Page 1, the program automatically stores 14 Lotus plot files when the user presses Alt-S. Not all of these graphs will normally be used in reports generated using STA LIFTBOAT (and not all of them have been included in this document). Additionally, users familiar with spreadsheet programs may select an infinite number of alternative graphs if they wish to examine results in more detail.

The Lotus plot files may be printed directly using Lotus PRINTGRAPH, a package that is incorporated into both 1-2-3 and SYMPHONY. The graphs in this document were printed using Harvard Graphics. They are direct from STA LIFTBOAT and have not been re-touched, just sent through Harvard.

HARDWARE REQUIREMENTS

A 286 or 386-based PC with 2 MB RAM, an EGA or VGA color adaptor and monitor, a hard disk with 6 MB space available, and a high-density 5.25-inch or 3.5-inch floppy drive are required to load and run both SYMPHONY and STA LIFTBOAT. If SYMPHONY (version 2.2, or later, with ALWAYS) is already installed on your machine, you will only need 1 MB hard disk space to install STA LIFTBOAT.

A laser printer is the ideal device to produce reports, but good quality output can be obtained on ink-jet printers and modern high resolution dot-matrix printers. All the graphs can be printed in color on an HP PaintJet or similar printer.

SUMMARY

STA LIFTBOAT provides a rapid and extremely efficient analytical tool to liftboat designers and to engineers who must assess the in-service performance of liftboats. Where doubt exists as to appropriate coefficients, the user is advised to select the most reasonable conservative values which result in the greatest pad loads and the lowest factors of safety against overturning. If the final results show that pad loading will exceed preload capabilities, if factors of safety against overturning are less than 1.1, or if unity stress checks exceed 1.0, then the user should consider carefully whether or not over-conservatism has been used or whether the boat should not be allowed to operate under these conditions.

REFERENCES

1. Det norske Veritas, *Rules for Classification of Mobile Offshore Units*, Part 3, 1985, 1986.
2. Shell Internationale Petroleum Maatschappij B.V., The Hague, *Practice For The Site-Specific Assessment of Jack-Up Units*, May 1989
3. American Bureau of Shipping, *Rules for Building and Classing Mobile Offshore Drilling Units*, 1988, with Notice No. 1, May 1989, and Notice No. 2, May 1990.
4. Det norske Veritas, Classification Note No. 31.5, *Strength Analysis of Main Structures of Self Elevating Units*, May 1984 (under revision).
5. Brekke, J.N., Murff, J.D., Campbell, R.B., and Lamb, W.C., *Calibration of Jack-Up Leg Foundation Model Using Full-Scale Structural Measurements*, OTC 6127, Houston, TX, May 1989.
6. Stewart, W.P., *Liftboat Leg Strength Structural Analysis*, Draft Final Report prepared for US Coast Guard, June 1990.
7. American Petroleum Institute, *Recommended Practice for Planning, Designing and Constructing Fixed Offshore Platforms*, API RP 2A, Section 3, 18th Edition, September 1989.

APPENDIX 5

Program Comparison With Finite Element Solution

The computer program, STA LIFTBOAT, has been compared with a finite element analysis of the generic liftboat performed using the commercially available program NISA from Engineering Mechanics Research Corporation, Troy, Michigan. The comparison is summarized in a single table on page A5-4 of this Appendix. It should be noted that the finite element analysis is a linear elastic analysis and does not include secondary bending effects. Furthermore, the finite element analysis is static and does not include dynamic responses. Consequently, there are several adjustments to be made when comparing the two solutions. The main purpose of the comparison is to insure that the simplified assumption of equal horizontal reaction at the footings is reasonable.

Description of Finite Element Solution

The wind load calculated for an attack angle of 69.25 degrees is applied at the correct location in the finite element model. It is applied as a load in the x-direction and a load in the y-direction. The loads are noted on the summary pages from the comparison.

The wave and current loads calculated by STA LIFTBOAT for each leg (at the point during the wave cycle when the overturning moment is a maximum) are applied to the finite element model. Each load is applied at the correct elevation as a combination of a point load in the x-direction and a point load in the y-direction.

The pads are assumed to be pin-jointed at the sea bed. The hull is modelled with 3-D beam elements which have two orders of stiffness greater magnitude than the 3-D beam elements used to model the legs. The correct area moments of inertia for bending about the local x and y axes are modelled for each leg. The connections of the legs to the hull are modelled as a series of constraints. These constraints force the lateral deflections of leg nodes to follow the lateral deflections of the hull nodes at the elevation of the upper and lower guides, without transmitting moments or vertical forces at these locations. The vertical reaction between the hull and the legs at the level of the pinions is also modelled as a constraint applied to a short member attached to the leg linked to a stiff member attached to the hull. This short member simulates the eccentricity of the pinions on the racks attached to the legs.

Since the finite element solution in this version of NISA is linear the reduction of sway stiffness caused by axial loading is not computed.

Although the main objective is to check that the resulting horizontal footings reactions are close to the equal reactions assumed in STA LIFTBOAT, it is also important to check that the calculated bending moments in the legs at the level of the lower guide compare closely with the bending moments calculated in STA LIFTBOAT. Deflections and pad rotations should also be compared.

The input and output from the final NISA run is included on pages A5-11 to A5-24. Idealizations of the finite element model, showing node numbers and element numbers are included on pages A5-25 to A5-31, with some hand annotation for clarity.

Description of STA LIFTBOAT Results

The input for the STA LIFTBOAT comparison run is shown on page A5-5. The data reflects the generic liftboat characteristics originally defined by the Coast Guard, with the environmental conditions as originally defined by the Coast Guard (see also Tables 1.1 and 2.1 in the main text of this Final Report).

The input data on page A5-5 defines loading only. The additional input data for the STA LIFTBOAT comparison run (defined by the user at the intermediate input stage) is shown on page A5-6. Note that on page A5-6 the natural period multiplier has been set to 0.01. This switches off dynamics and allows investigation of what the response would be if the loading was applied statically. Results for this data and the main load definition data (page A5-5) are given in the table on page A5-7. Numbers for applied horizontal loads, lateral displacements of the hull, bending moments in the legs, and rotations of the pads have been abstracted from page A5-7 and included in the comparison table on page A5-4.

On page A5-8 another set of intermediate data is given, this time with the natural period multiplier set to 1.0 (the same loading data as for the previous run is used) and this yields the set of results given on page A5-9. The dynamic amplification factor is 1.19 and may be compared to that of 1.0 on page A5-7, where dynamics was switched off. Larger sway response, leg bending moments, etc. occur with the larger DAF. Selected results from page A5-9 are also reproduced in the comparison table on page A5-4.

In addition to the two output tables shown on pages A5-7 and A5-9, STA LIFTBOAT was run with virtually zero hull mass. The consequence of zero hull mass idealization is to increase lateral sway stiffness, for closer comparison with the FE results. Values for leg bending moments without the P-delta effect are given in the normal output. Values for the average hull sway, or lateral displacement with hull weight, W , set to zero, and for pad rotation with $W = 0$, are included in the comparison table on page A5-4.

Summary of the Comparison

It can be seen from the next page that the comparison is quite good. The difference between static horizontal components of reaction at the footings is a maximum of only 6.5% between the two models. Similarly, the bending moments at the level of the lower guides, calculated statically, without the P-delta effect, differ by a maximum of only 6.6%. This indicates that static bending stresses, without the P-delta effect, would differ by only 6.5%. Note that the difference between the static bending moment, without the P-delta effect and with the P-delta effect is 2333:3251 ft-kips, or an increase of 39%. When dynamics are included the final maximum bending moment at the hull with the P-delta effect increases to 3483 ft kips. This is an increase of 49% over the static linear (without P-delta effect) value.

It will be seen that the resultant horizontal, static, footing reactions (the terms labeled PH) show quite small differences, the largest being 6.5%. The vertical reactions are extremely close with no difference larger than 0.5%.

The differences in the static values for lateral displacements of the hull at the level of the lower guides are partly caused by Release 1.0 of STA LIFTBOAT not reporting torsional response, but mainly because the axial load in STA LIFTBOAT causes a reduction in sway stiffness. If the average sway values are compared STA LIFTBOAT is 21% greater than the NISA results. However, when the hull mass is set to zero the difference is only 0.4% (see the line labeled "Av. dip. W=0" on page A5-4).

The difference between the average pad rotations is 6.3% between the two models.

Although axial loads caused by gravitational effects were not included in the comparison, it is anticipated that the comparison of axial stresses would be to within 1%, hence total stress levels, statically, without the P-delta effect should be within 4% in the two models.

Conclusions From Comparison

STA LIFTBOAT produces results which are within 6.5% of the results produced by a finite element approach for static linear leg bending moments. The model may be regarded as having been reliably calibrated for static linear results.

The simplifying assumption of equal horizontal pad reactions is reasonable, resulting in errors in static bending stresses of a maximum of 6.5% in the case studied. Combined static linear stresses should be within 4% (axial plus bending).

Second order bending stresses, including dynamic effects, significantly increase static stress levels, by 49% in the case studied.

COMPARISON OF RESPONSE RESULTS Between STA programs and FE method

ENVIRONMENTAL CONDITIONS					
Wind	70.00	knots			
Wave Ht.	20.00	feet	Period	10.00	seconds
Current	2.00	knots	Direction	69.25	degrees
APPLIED LOADS					
Wind Tot.	38.00	kips	x-coord.	y-coord.	z-coord.
Fx, wind	13.30	kips	(feet)	(feet)	(feet)
Fy, wind	35.12	kips	26.92	0.00	10.96
Wave Tot.	72.00	kips	eff. ht.	56.07	feet
Fx, leg1	8.04	kips	Fy, leg1	21.23	kips
Fx, leg2	9.17	kips	Fy, leg2	24.20	kips
Fx, leg3	8.25	kips	Fy, leg3	21.97	kips

RESPONSE RESULTS						
Variable	FE soln.	STA stat.	STA dyn.	stat.diff.	dyn.diff.	units
Tot. P	109.50	109.50	118.00	0.0%	7.8%	kips
Px, leg1	-15.10	-12.93	-13.94	-14.4%	-7.7%	kips
Px, leg2	-15.10	-12.93	-13.94	-14.4%	-7.7%	kips
Px, leg3	-8.60	-12.93	-13.94	50.4%	62.0%	kips
Py, leg1	-33.20	-34.13	-36.78	2.8%	10.8%	kips
Py, leg2	-36.00	-34.13	-36.78	-5.2%	2.2%	kips
Py, leg3	-33.40	-34.13	-36.78	2.2%	10.1%	kips
PH, leg1	-36.47	-36.50	-39.33	0.1%	7.8%	kips
PH, leg2	-39.04	-36.50	-39.33	-6.5%	0.8%	kips
PH, leg3	-34.49	-36.50	-39.33	5.8%	14.0%	kips
Average PH	-36.67	-36.50	-39.33	-0.5%	7.3%	kips
Pz, leg1	-159.30	-158.50	-170.80	-0.5%	7.2%	kips
Pz, leg2	39.90	39.80	42.90	-0.3%	7.5%	kips
Pz, leg3	119.30	119.30	127.90	0.0%	7.2%	kips
Mhull, I1	2386.00	2333.30	2488.00	-2.2%	4.3%	kip-ft
Mhull, I2	2497.00	2333.30	2488.00	-6.6%	-0.4%	kip-ft
Mhull, I3	2188.00	2333.30	2488.00	6.6%	13.7%	kip-ft
Average Mhull	2357.00	2333.30	2488.00	-1.0%	5.6%	kip-ft
x-disp, leg1	1.22	1.06	1.13	-13.2%	-7.4%	ft
x-disp, leg2	0.61	1.06	1.13	73.7%	85.3%	ft
x-disp, leg3	0.92	1.06	1.13	15.1%	22.8%	ft
y-disp, leg1	2.01	2.80	2.98	39.1%	48.4%	ft
y-disp, leg2	2.01	2.80	2.98	39.1%	48.4%	ft
y-disp, leg3	2.81	2.80	2.98	-0.5%	6.2%	ft
Average disp.	2.47	2.99	3.19	21.1%	29.2%	ft
Av. disp. W=0	2.47	2.48		0.4%		ft
Theta, leg1	2.25	2.52	2.70	12.0%	20.0%	degrees
Theta, leg2	2.85	2.52	2.70	-11.6%	-5.3%	degrees
Theta, leg3	2.01	2.52	2.70	25.4%	34.3%	degrees
Average Theta	2.37	2.52	2.70	6.3%	13.9%	degrees
Av. Theta W=0	2.37	2.22		-6.3%		degrees

STA LIFTBOAT v1.0 June 1990		07/04/90 Date of this run	
!!!! THIS IS THE DATA INPUT & INTERMEDIATE PROCESSING FILE !!!!			
AFTER ALL DATA IS INPUT/CHANGED, PRESS ALT-A. RESULTS FILE WILL LOAD.			
PRINTING: Alt-P for input; Alt-W for wind.		Boat name: Generic 1	
Run Ref.: NISA FE Comparison, final report		<<<appears on graphs	
COPYRIGHT 1990 STEWART TECHNOLOGY ASSOCIATES			
This spreadsheet program uses the ABS 1985 Rules method for finding wave forces on a LIFTBOAT. The user is prompted for data, and for controls. Only data in shaded cells can be edited. Last data used is displayed.			
EDIT INPUT DATA		5 AvShield	69.25 1st wave angle (deg)
20 Input wave height (ft)	3.51	3.51	3.51 Leg diams 1,2,3 (ft)
10 Input wave period (sec)	2	2	2 Cm1, Cm2, Cm3
65 Input water depth (ft)	0.71	0.62	0.71 CD1, CD2, CD3
100 Lattice area (sqft)	30 lattice av.ht.		70 wind v2 (kn)
10 WH1 (ft)	30 WH2 (ft)	2 tide vel (kn)	0 wind v1 (kn)
95 WB (ft)	30 WL (ft)	0.22 LeverArm	537.0 Total weight (kips)
65 distance from aft to fwd legs (ft)			200 LCG (ft to aft legs)
65 distance bet. fwd. leg centers (ft)			0 TCG (+ve towards L1)
2 pad penetration int	1 leg buoy. 1=dry		0 init phase ang (deg)
20 windforce kips	20 air gap (ft)		100 wind elev (ft)
Wind force switch: 2	(1=input; 2=computed)		100 tot. leg length (ft)

STA LIFTBOAT v1.0 June 1990		07/04/90 Date of run
FINAL PROCESSING FILE		Boat Name: Generic 1
Run Ref.: NISA FE Comparison, final report		<appears on graphs
Press Alt-S to save graphs, Alt-A for RESULTS SUMMARY, Alt-B for stress check Press Alt-I to print this input, Alt-R for results, Alt-C for stress checks		
EDIT USER DEFINED VARIABLES		
4248000	Young's Modulus, leg steel (ksf)	2.16 K-equivalent
0.01	nat.period multiplier (norm.=1; no dyn.=.01)	
00	yield stress for leg steel	1 add.mass coef.(norm.=1)
2	accept calc. wt/ft (1=no, 2=yes)	5 VCG excluding legs (ft)
2	accept hull gyrad. (1=no, 2=yes)	15 weight of 1 pad (kips)
0	coef.on su to get soil G modulus	0.285 calculated leg kips/ft
100	su, soil und.shear str. (psf)	30.18 calculated hull gyrad.
0	ks, calc.rot.stiff.soil (kip-ft/rad)	0.28 USER SPEC.leg kips/foot
0.00E+00	kj, rot.stiff.jack/hull (kip-ft/rad)	30 USER SPEC. gyrad. (ft)
10.42	k, calc.overall leg stiff.(kips/ft)	0.00 Beta, calculated
0.000	Ke0, horiz.offset coef.	0.00 Mu, calculated
0.64	cylinder drag coef.(w/marine growth)	2 total damping (% crit.)
0.00	marine growth thickness (Inches)	0 Beta maximum
INPUT STRUCTURAL LEG DATA BELOW:		
0	VCG lower guide (ft)	1 geometry select.switch
48	leg OD (In)	14 d, guide spacing (ft)
0.2	wall thickness (In)	7 b, jack vcg (ft)
4	rack width (In)	4.5 h, jack support spacing (ft)
4	rack height to top teeth (In)	25 pad length (ft)
1.5	rack height to bot. teeth (In)	10 pad width (ft)
4.5	stiffener area in sqin	1.5 pad 1/2 height (ft)
0.00	leg wt.factor for appendages, etc	1 1 OR 2 RACK SWITCH
2ND Title for drag coefficient graph >>>>		LIFTBOAT 42 INCH DIAMETER LEG

STA LIFTBOAT v1.0 June 1990

07/04/90 Date of this run

TABLE OF RESULTS Run Ref.: NISA FE Comparison, final report

STA LIFTBOAT v1.0 June 1990

Boat Name: Generic 1

INPUT SUMMARY

LIFTBOAT TYPE 1 STA RIG # # N

Wave height	20 feet	Tidal current	2 knots
Wave period	10 seconds	Wind driven curr.	0 knots
Water depth	65 feet	Pad penetration	3 feet
theta, wave dirn.	69.25 degrees	Air gap	20 feet
Wind force	COMPUTE BELOW	Wind speed	70 knots
Leg equiv.av.dla.	3.51 feet	Av. leg mass coef.	2 coef.
Damping ratio	2 % crit.	Av. leg drag coef.	0.75 coef.
Total weight	537.5 kips	Beta, top fixity	0.00 ratio
ks, soil stiff.	0.00E+00 kipft/rad	Mu, bottom fixity	0.00 ratio
su, soil und.ss.	160 psf	Kj, JackHull stiff	8.00E+05 kipft/rad
Gfactor on su	0 coef.	Equiv. pad radius	8.92 feet
LCG	20 feet	TCG	0 feet
Ke0, Offset coef.	0.003 LegLength	VCG excldng. legs	5 feet
Fwd-aft leg dist	66 feet	Fwd leg spacing	50 feet
LegLength extend.	88 feet	Total leg length	130 feet

STA LIFTBOAT v1.0 June 1990

Legs are dry internally

RESULTS SUMMARY

LIFTBOAT TYPE 1 STA RIG # # N

Pad1 bef.env.loads	145 kips	Pad2 bef.env.loads	121 kips
Pad3 bef.env.loads	145 kips	Weight - buoyancy	411 kips
Av.leg buoyancy	42 kips	Total buoyancy	126 kips
Lateral Stiffness	31 kips/ft	lateral x-stiff.	29 kips/ft
Wind force	38 kips	lateral y-stiff.	32 kips/ft
Max wav-cur.force	72 kips	Mean wav-cur.force	29 kips
Wind O/T moment	3717 ft-kips	Max. total force	109 kips
Amp.wav/cur.O/Tm	2185 ft-kips	Mean wav-cur.O/Tm	1510 ft-kips
Tnxx sway period	4.18 seconds	Max.apparent O/Tm	7411 ft-kips
Tnyy sway period	4.00 seconds	Max torsion mom.	464 ft-kips
Nat. tor. period	0.03 seconds	DAF	1.00 ratio
Mean hull defn.	1.92 feet	Hull defn. amp.	0.95 feet
Max hull defn. *	2.99 feet	Offset+defn. **	3.25 feet
Uncorr.stab.mom.	6700 ft-kips	Euler leg load	783 kips
Corr.stab.mom.	4863 ft-kips	Max. base shear	109 kips
Max.Up.guide reac.	232.2 kips	Max.low.gde.reac.	263 kips
Max.equiv.top load	93.38 kips	Max.horiz.SC.reac.	31.13 kips
BM.pad.max.w/o.PD.	0 ft-kips	BM.hull max.w/oPD.	2333 ft-kips
PDelta leg BM.max	917 ft-kips	BM.hull max. w.PD.	3251 ft-kips
PadMax.id.uncorrd.	264 kips	PadMin.id.uncorrd.	-13 kips
PadMax.id.corrected	282 kips	PadMin.id.corrected	-38 kips
Pad mean angle	1.6037 degrees	Pad max.angle	2.5199 degrees
Max.OT w/o PDelta	7411 ft-kips	Max.OT.mom.w.PD	8559 ft-kips
Max.hull ax.F1,F3	191.0 kips	Static offset **	3.17 inches
Max.hull ax.F2	144.1 kips	K-Equivalent	2.16 coef.
max fb, legs 1,3	45.78 ksi	Uncorr. O/T SF	0.90 ratio
max fb, top leg 2	56.15 ksi	Corrected O/T SF	0.78 ratio
max fa, legs 1,3	2.52 ksi	DnV O/T Safety F.	0.66 ratio
max fa, top leg 2	1.90 ksi	K=2 Unity chk.legs1,3	1.52 ratio
Hull max.shr.str.	3.48 ksi	K=2 Unity chk.leg2	1.58 ratio
fa/Fa ABS leg 2	0.23 ratio	K-equiv.Un.chk.legs1,3	1.67 ratio
fb/Fb ABS leg 2	1.24 ratio	K-equiv.Un.chk.leg2	1.69 ratio

STA LIFTBOAT v1.0 June 1990		07/04/90 Date of run
FINAL PROCESSING FILE		Boat Name: Generic 1
Run Ref.: NISA FE Comparison. final report		<appears on graphs
Press Alt-S to save graphs, Alt-A for RESULTS SUMMARY, Alt-B for stress check		
Press Alt-I to print this input, Alt-R for results, Alt-C for stress checks		
EDIT USER DEFINED VARIABLES		
4248000	Young's Modulus, leg steel (ksf)	2.16 K-equivalent
1	nat.period multiplier (norm.=1; no dyn.=.01)	1 add.mass coef.(norm.=1)
60	yield stress for leg steel	5 VCG excluding legs (ft)
2	accept calc. wt/ft (1=no, 2=yes)	15 weight of 1 pad (kips)
2	accept hull gyrad. (1=no, 2=yes)	0.285 calculated leg kips/ft
0	coef.on su to get soil G modulus	30.18 calculated hull gyrad.
160	su, soil und.shear str. (psf)	0.28 USER SPEC.leg kips/foot
0	ks, calc.rot.stiff.soil (kip-ft/rad)	30 USER SPEC. gyrad. (ft)
8.00E+05	kj, rot.stiff.jack/hull (kip-ft/rad)	0.00 Beta, calculated
10.42	k, calc.overall leg stiff.(kips/ft)	0.00 Mu, calculated
0.003	Ke0, horiz.offset coef.	2 total damping (% crit.)
0.6	cylinder drag coef.(w/marine growth)	0 Beta maximum
0.00	marine growth thickness (inches)	
INPUT STRUCTURAL LEG DATA BELOW:		
0	VCG lower guide (ft)	1 geometry select.switch
42	leg OD (in)	14 d, guide spacing (ft)
0.5	wall thickness (in)	7 b, jack vcg (ft)
4	rack width (in)	4.5 h, jack support spacing (ft)
4	rack height to top teeth (in)	25 pad length (ft)
1.5	rack height to bot. teeth (in)	10 pad width (ft)
4.5	stiffener area in sqin	1.5 pad 1/2 height (ft)
0.04	leg wt.factor for appendages, etc	1 1 OR 2 RACK SWITCH
2ND Title for drag coefficient graph >>>>		LIFTBOAT 42 INCH DIAMETER LEG

STA LIFTBOAT v1.0 June 1990

07/04/90 Date of this run

TABLE OF RESULTS Run Ref.: NISA FE Comparison, final report

STA LIFTBOAT v1.0 June 1990

INPUT SUMMARY

Wave height	20 feet
Wave period	10 seconds
Water depth	65 feet
theta, wave dirn.	69.25 degrees
Wind force	COMPUTE BELOW
Leg equiv.av.dia.	3.51 feet
Damping ratio	2 % crit.
Total weight	537.5 kips
ks, soil stiff.	0.00E+00 kipft/rad
su, soil und.ss.	160 psf
Gfactor on su	0 coef.
LCG	20 feet
Ke0, Offset coef.	0.003 LegLength
Fwd-aft leg dist	66 feet
LegLength extend.	88 feet

Boat Name: Generic 1

LIFTBOAT TYPE 1

STA RIG # # N

Tidal current	2 knots
Wind driven curr.	0 knots
Pad penetration	3 feet
Air gap	20 feet
Wind speed	70 knots
Av. leg mass coef.	2 coef.
Av. leg drag coef.	0.75 coef.
Beta, top fixity	0.00 ratio
Mu, bottom fixity	0.00 ratio
kj, JackHull stiff	8.00E+05 kipft/rad
Equiv. pad radius	8.92 feet
TCG	0 feet
VCG excludng. legs	5 feet
Fwd leg spacing	50 feet
Total leg length	130 feet

STA LIFTBOAT v1.0 June 1990

Legs are dry internally

RESULTS SUMMARY

Pad1 bef.env.loads	145 kips
Pad3 bef.env.loads	145 kips
Av.leg buoyancy	42 kips
Lateral Stiffness	31 kips/ft
Wind force	38 kips
Max wav-cur.force	72 kips
Wind O/T moment	3717 ft-kips
Amp.wav/cur.O/Tm	2185 ft-kips
Tnxx sway period	4.18 seconds
Tnyy sway period	4.00 seconds
Nat. tor. period	3.49 seconds
Mean hull defln.	1.92 feet
Max hull defln.*	3.19 feet
Uncorr.stab.mom.	6700 ft-kips
Corr.stab.mom.	4748 ft-kips
Max.Up.guide reac.	248.8 kips
Max.equiv.top load	99.75 kips
BM.pad.max.w/o.PD.	0 ft-kips
PDelta leg BM.max	1009 ft-kips
PadMax.Id.uncorrd.	264 kips
PadMax.Id.corrected	292 kips
Pad mean angle	1.6037 degrees
Max.OT w/o PDelta	7831 ft-kips
Max.hull ax.F1,F3	191.0 kips
Max.hull ax.F2	144.1 kips
max fb, legs 1,3	49.05 ksi
max fb, top leg 2	60.16 ksi
max fa, legs 1,3	2.52 ksi
max fa, top leg 2	1.90 ksi
Hull max.shr.str.	3.73 ksi
fa/Fa ABS leg 2	0.23 ratio
fb/Fb ABS leg 2	1.33 ratio

LIFTBOAT TYPE 1

STA RIG # # N

Pad2 bef.env.loads	121 kips
Weight - buoyancy	411 kips
Total buoyancy	126 kips
lateral x-stiff.	29 kips/ft
lateral y-stiff.	32 kips/ft
Mean wav-cur.force	29 kips
Max. total force	109 kips
Mean wav-cur.O/Tm	1510 ft-kips
Max.apparent O/Tm	7411 ft-kips
Max torsion mom.	464 ft-kips
DAF	1.19 ratio
Hull defln. amp.	1.13 feet
Offset-defln.**	3.45 feet
Euler leg load	783 kips
Max. base shear	118 kips
Max.low.gde.reac.	282 kips
Max.horiz.SC.reac.	33.25 kips
BM.hull max.w/oPD.	2474 ft-kips
BM.hull max. w.PD.	3483 ft-kips
PadMin.Id.uncorrd.	-13 kips
PadMin.Id.corrected	-51 kips
Pad max.angle	2.6960 degrees
Max.OT.mom.w.PD	9045 ft-kips
Static offset **	3.17 inches
K-Equivalent	2.16 coef.
Uncorr. O/T SF	0.90 ratio
Corrected O/T SF	0.74 ratio
DnV O/T Safety F.	0.61 ratio
K=2 Unity chk.legs1,3	1.61 ratio
K=2 Unity chk.leg2	1.68 ratio
K-equiv.Un.chk.legs1,3	1.77 ratio
K-equiv.Un.chk.leg2	1.80 ratio

DATE MARCH 27 1990
 JCB NAME LIFTBOAT LEGS
 JOB NUMBER STA 054
 SHEET NO. A5-10 OF
 BY WPS SCALE N/A

LOAD CASE SUMMARY (WIND)	
LOAD DIRECTION, $\theta^\circ = 69.25^\circ$	
ELEVATION OF APPLIED LOADS = 10.96 (above base)	
X-COORDINATE = 26.92	Y-COORD = 0.0
FX WIND (KIPS)	FY WIND
13.30	35.12

LOAD CASE SUMMARY (WAVES)		
ELEVATION OF APPLIED LOADS = 51.76' (above base)		
	FX (KIPS)	FY (KIPS)
LEG 1	8.04	21.23
LEG 2	8.25	21.97
LEG 3	9.17	24.20

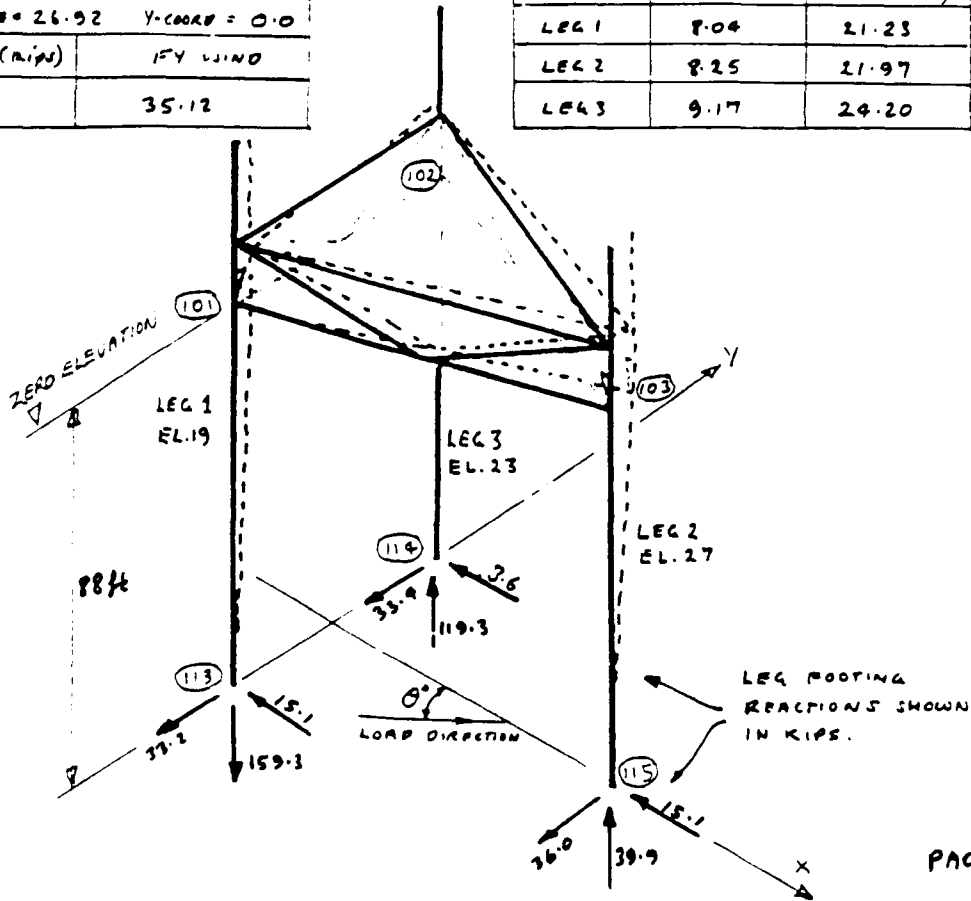

PAGE A5

ROTATION ABOUT Z-AXIS = 0.70°				AV. EFFECTIVE ROTATION OF FOOTINGS ABOUT Z-AXIS			
DISPLACEMENTS AT NODES (FT)				ROTATIONS AT NODES (DEGREES)			
NODE #	UX	UY	U _{max} (AVG)	NODE #	θ_x (RAD)	θ_y (RAD)	θ_{tot} °
101	1.22	2.01	2.35	113 leg 1	-0.0336	0.0203	2.25°
102	0.61	2.01	2.10	114 leg 3	-0.0336	0.0105	2.01°
103	0.92	2.81	2.96	115 leg 2	-0.0472	0.0153	2.85°
STA LIFTBOAT RESULTS FOR COMPARISON				MOMENTS AT NODES (FT-KIPS)			
	θ_{max} °	W/O P-Delta M _{max}	U _{max}	NODE #	M _x	M _y	M _{tot}
W=0, STAT	2.22°	2333	2.48	101	2150	1036	2386
W=537, STAT	2.52°	2488	2.99	102	-997	-2289	2497
W=537, DYN	2.70°	2488	2.19	103	2140	-455	2188

STEWART TECHNOLOGY ASSOCIATES - LIFTBOAT ANALYSIS
NISA Finite Element Analysis Results For 65 feet Water Depth
70 knot wind, 20 foot wave height, 10 seconds period, 2 knot current
Page 1

**EXECUTIVE 65FT WATER DEPTH CASE, 70KNOTS,2KNOTS,20FT,10S

ANAL=STATIC

FILE=LIFT

SAVE=26,27

*ELTYPE

1, 12, 1
 2, 26, 1

*RCTABLE

1, 3
 5.5000, 550.5000, 550.5000

2, 10, 4
 0.52561, 0.8897, 0.6769, 0

0, 0, 0, 0
 1.9, 1.9, 0, 0

12, 18, 4
 0.52561, 0.8897, 0.6769, 0

0, 0, 0, 0
 1.9, 1.9, 0, 0

0, 0, 0, 0
 0, 90

3, 1
 5.334

4, 1
 0.2487

*ELEMENT

1, 2, 1, 1, 0
 1, 2, 1, 1, 0
 2, 2, 1, 1, 0
 2, 4, 1, 1, 0
 3, 2, 1, 1, 0
 4, 6, 1, 1, 0
 4, 2, 1, 1, 0
 6, 8, 1, 1, 0
 5, 2, 1, 1, 0
 8, 10, 1, 1, 0
 6, 2, 1, 1, 0
 10, 1, 1, 1, 0
 7, 2, 1, 1, 0
 13, 14, 1, 1, 0
 8, 2, 1, 1, 0
 14, 16, 1, 1, 0
 9, 2, 1, 1, 0
 16, 13, 1, 1, 0
 10, 2, 1, 1, 0
 13, 2, 1, 1, 0
 11, 2, 1, 1, 0
 2, 14, 1, 1, 0
 12, 2, 1, 1, 0
 14, 6, 1, 1, 0
 13, 2, 1, 1, 0
 6, 16, 1, 1, 0
 14, 2, 1, 1, 0
 16, 10, 1, 1, 0
 15, 2, 1, 1, 0
 10, 13, 1, 1, 0
 16, 2, 1, 1, 0
 1, 32, 1, 12, 0
 17, 2, 1, 1, 0
 4, 34, 1, 12, 0
 18, 2, 1, 1, 0
 8, 36, 1, 12, 0
 200, 2, 1, 1, 0
 13, 200, 1, 1, 0
 201, 2, 1, 1, 0
 14, 200, 1, 1, 0
 202, 2, 1, 1, 0
 200, 16, 1, 12, 0
 19, 1, 1, 12, 0
 113, 101, 1, 12, 0
 20, 1, 1, 12, 0
 101, 119, 1, 12, 0
 21, 1, 1, 12, 0
 119, 104, 1, 12, 0
 22, 1, 1, 12, 0
 104, 116, 1, 12, 0
 23, 1, 1, 12, 0
 114, 102, 1, 12, 0
 24, 1, 1, 12, 0
 102, 120, 1, 12, 0
 25, 1, 1, 12, 0
 120, 105, 1, 12, 0
 26, 1, 1, 12, 0
 105, 117, 1, 2, 0
 27, 1, 1, 2, 0

STEWART TECHNOLOGY ASSOCIATES - LIFTBOAT ANALYSIS
NISA Finite Element Analysis Results For 65 feet Water Depth
70 knot wind, 20 foot wave height, 10 seconds period, 2 knot current
Page 2

```

115, 103,
28, 1, 1, 2, 0
103, 121,
29, 1, 1, 2, 0
121, 106,
30, 1, 1, 2, 0
106, 118,
31, 1, 1, 2, 0
119, 129,
32, 1, 1, 2, 0
120, 130,
33, 1, 1, 2, 0
121, 131,
40, 2, 1, 1, 0
1, 13,
41, 2, 1, 1, 0
4, 14,
42, 2, 1, 1, 0
8, 16,
43, 2, 2, 3,
5
44, 2, 2, 3,
10
45, 2, 2, 3,
2
46, 2, 2, 4,
113
47, 2, 2, 4,
114
48, 2, 2, 4,
115

```

```

*NODES
1 , , , , 0.0000, -25.0000, 0.0000,
2 , , , , 0.0000, 0.0000, 0.0000,
4 , , , , 0.0000, 25.0000, 0.0000,
6 , , , , 33.0000, 12.5000, 0.0000,
8 , , , , 66.0000, 0.0000, 0.0000,
10 , , , , 33.0000, -12.5000, 0.0000,
13 , , , , 0.0000, -25.0000, 14.0000,
14 , , , , 0.0000, 25.0000, 14.0000,
16 , , , , 66.0000, 0.0000, 14.0000,
32 , , , , 0.0000, -23.1000, 7.0000,
34 , , , , 0.0000, 23.1000, 7.0000,
36 , , , , 64.1000, 0.0000, 7.0000,
101 , , , , 0.0000, -25.0000, 0.0000,
102 , , , , 0.0000, 25.0000, 0.0000,
103 , , , , 66.0000, 0.0000, 0.0000,
104 , , , , 0.0000, -25.0000, 14.0000,
105 , , , , 0.0000, 25.0000, 14.0000,
106 , , , , 66.0000, 0.0000, 14.0000,
113 , , , , 0.0000, -25.0000, -88.0000,
114 , , , , 0.0000, 25.0000, -88.0000,
115 , , , , 66.0000, 0.0000, -88.0000,
116 , , , , 0.0000, -25.0000, 37.0000,
117 , , , , 0.0000, 25.0000, 37.0000,
118 , , , , 66.0000, 0.0000, 37.0000,
119 , , , , 0.0000, -25.0000, 7.0000,
120 , , , , 0.0000, 25.0000, 7.0000,
121 , , , , 66.0000, 0.0000, 7.0000,
124 , , , , 0.0000, 35.0000, -88.0000,
125 , , , , 66.0000, 10.0000, -88.0000,
129 , , , , 0.0000, -23.1000, 7.0000,
130 , , , , 0.0000, 23.1000, 7.0000,
131 , , , , 64.1000, 0.0000, 7.0000,
200 , , , , 26.9200, 0.0000, 10.9600,

```

```

*MATERIAL
EX,1,,4.24800E+06
NUXY,1,,0.28000E+00
DENS,1,,0.01685
EX,2,,4.24800E+06
NUXY,2,,0.28000E+00
DENS,2,,0.0

```

```

*CPDISP
UX$1,101
UY$1,101
UX$4,102
UY$4,102
UX$8,103
UY$8,103
UX$13,104
UY$13,104
UX$14,105
UY$14,105
UX$16,106

```

STEWART TECHNOLOGY ASSOCIATES - LIFTBOAT ANALYSIS
NISA Finite Element Analysis Results For 65 feet Water Depth
70 knot wind, 20 foot wave height, 10 seconds period, 2 knot current
Page 3

UY\$16,106
UZ\$32,129
UZ\$34,130
UZ\$36,131
ROTZ\$32,129
ROTZ\$34,130
ROTZ\$36,131
*LDCASE, ID=1
1,1,0,0
*SPDISP
113,UXYZ,0.0,115,1
*BEAMLOAD
23,0,1,0,0,0,51.76,51.76,8.25,,
23,1,1,0,0,0,51.76,51.76,21.97,,
19,0,1,0,0,0,51.76,51.76,8.04,,
19,1,1,0,0,0,51.76,51.76,21.23,,
27,1,1,0,0,0,51.76,51.76,-9.17,,
27,0,1,0,0,0,51.76,51.76,24.2,,
*LDCASE, ID=2
1,1,0,0
*CFORCE
200,FX,13.3,200,,
200,FY,35.12,200,,
*LDCOMB, ID=3
1,1,1
1,1
2,1
*PRINTCNTL
ELFO,0
ELSTR,0
*ENDDATA

STEWART TECHNOLOGY ASSOCIATES - LIFTBOAT ANALYSIS
NISA Finite Element Analysis Results For 65 foot Water Depth
70 knot wind, 20 foot wave height, 10 seconds period, 2 knot current
Page 4

PUT FILE - liftb17.ms
 NISA JOB STARTED AT - 21:49:54 3/27/1990
 LINE 1 **EXECUTIVE 65FT WATER DEPTH CASE, 70KNOTS,2KNOTS,20FT,10S
 LINE 2 ANAL=STATIC
 LINE 3 FILE=LIFT
 LINE 4 SAVE=26.27
 LINE 5 #ELTYPE
 *** E M R C N I S A *** - MS DOS/VERSION 88.7 - (083088) 3/27/1990 21:49:55

***** PROPRIETARY SOFTWARE PRODUCT OF *****

 * ENGINEERING MECHANICS RESEARCH *
 * CORPORATION *
 * 1707 W. BIG BEAVER, TROY, MICHIGAN 48064 U.S.A. *
 * TELEPHONE (313)643-6222 - TELEX 469232 *
 * WEST COAST BRANCH OFFICE: *
 * 22939 HAWTHORNE BLVD. #206 TORRANCE, CALIFORNIA 90505 *
 * TELEPHONE (213)378-8820 *

***** IBM-PC MS/DOS VERSION 88.7 - RELEASE 083088 *****

STATIC ANALYSIS

*** E M R C N I S A *** - MS DOS/VERSION 88.7 - (083088) 3/27/1990 21:49:55

SELECTION OF ELEMENT TYPES FROM THE NISA ELEMENT LIBRARY (*ELTYPE DATA GROUP)

NSRL	NKTP	NORDR	NODES/EL	DOF/NODE
1	12	1	2	6
2	26	1	1	3

E M R C N I S A *** - MS DOS/VERSION 88.7 - (083088) 3/27/1990 21:49:55

TABLE OF REAL CONSTANTS (*RCTABLE DATA GROUP)

INDEXRC /----- VALUES OF REAL CONSTANTS -----/

1	5.500000E+00	5.505000E+02	5.505000E+02					
2	5.255100E-01	8.897000E-01	5.769000E-01	0.000000E-01	0.000000E-01	0.000000E-01	0.000000E-01	0.000000E-01
	1.900000E+00	1.900000E+00						
12	5.256100E-01	8.897000E-01	5.769000E-01	0.000000E-01	0.000000E-01	0.000000E-01	0.000000E-01	0.000000E-01
	1.900000E+00	1.900000E+00	0.000000E-01	0.000000E-01	0.000000E-01	0.000000E-01	0.000000E-01	0.000000E-01
	0.000000E-01	9.000000E-01						
3	5.334000E+00							
4	2.487000E-01							

CONNECTIVITY ECHO SUPPRESSED FOR THIS RUN

*** E M R C N I S A *** - MS DOS/VERSION 88.7 - (083088) 3/27/1990 21:49:55

MATERIAL PROPERTY TABLE (*MATERIAL DATA GROUP)

MATERIAL INDEX 1

EX	1	0	4	2480000E+06	0.0000000E-01	0.0000000E-01	0.0000000E-01	0.0000000E-01
NUXY	1	0	2	8000000E-01	0.0000000E-01	0.0000000E-01	0.0000000E-01	0.0000000E-01
DENS	1	0	1	1.6850000E-02	0.0000000E-01	0.0000000E-01	0.0000000E-01	0.0000000E-01

STEWART TECHNOLOGY ASSOCIATES - LIFTBOAT ANALYSIS
NISA Finite Element Analysis Results For 65 feet Water Depth
70 knot wind, 20 foot wave height, 10 seconds period, 2 knot current
Page 5

MATERIAL INDEX 2

```

EX      2  0  4.2480000E+06  0.0000000E-01  0.0000000E-01  0.0000000E-01  0.0000000E-01
NUXY    2  0  2.8000000E-01  0.0000000E-01  0.0000000E-01  0.0000000E-01  0.0000000E-01
DENS    2  0  0.0000000E-01  0.0000000E-01  0.0000000E-01  0.0000000E-01  0.0000000E-01
*** E M R C   N I S A   *** - MS DOS/VERSION 88.7 - (083088)          3/27/1990  21:49:55
  
```

COUPLED NODAL DISPLACEMENTS (*CPDISP DATA GROUP)

 SET NO. DIRECTION LISTING OF COUPLED NODES

```

1      UX      1  101
2      JY      1  101
3      UX      4  102
4      JY      4  102
5      UX      8  103
6      JY      8  103
7      JX     13  104
8      JY     13  104
9      JX     14  105
10     JY     14  105
11     JX     16  106
12     JY     16  106
13     UZ     32  129
14     UZ     34  130
15     UZ     36  131
16     ROTZ   32  129
17     ROTZ   34  130
18     ROTZ   36  131
*** E M R C   N I S A   *** - MS DOS/VERSION 88.7 - (083088)          3/27/1990  21:49:55
  
```

OUTPUT CONTROL FOR LOAD CASE ID NO. 1

```

INTERNAL FORCE AND STRAIN ENERGY KEY ... (KELFR)= 1
REACTION FORCE KEY ..... (KRCTN)= 1
STRESS COMPUTATION KEY ..... (KSTR)= 0
STRAIN COMPUTATION KEY ..... (KSTN)= 0
ELEMENT STRESS/STRAIN OUTPUT OPTIONS ... (LQ1)= 0
NODAL STRESSES OUTPUT OPTIONS ..... (LQ2)= 0
DISPLACEMENT OUTPUT OPTIONS ..... (LQ7)= 0
STRESS FREE TEMPERATURE ..... (TSFRE)= 0.00000E-01
  
```

*** E M R C N I S A *** - MS DOS/VERSION 88.7 - (083088) 3/27/1990 21:49:55

SPECIFIED DISPLACEMENT DATA (*SPDISP DATA GROUP)

```

NODE NO. LABEL  DISPLACEMENT VALUE  LAST NODE  INC  LABEL
113 UXYZ      0.00000E-01      115      1
  
```

*** E M R C N I S A *** - MS DOS/VERSION 88.7 - (083088) 3/27/1990 21:49:55

DISTRIBUTED ELEMENT PRESSURE DATA

```

ELE. NO.  IPL  IRL  IFM      NODAL PRESSURE VALUES
23      0      1      0      5.17600E+01  5.17600E+01  8.25000E+00  0.00000E-01
23      1      1      0      5.17600E+01  5.17600E+01  2.19700E+01  0.00000E-01
19      0      1      0      5.17600E+01  5.17600E+01  8.04000E+00  0.00000E-01
19      1      1      0      5.17600E+01  5.17600E+01  2.12300E+01  0.00000E-01
27      1      1      0      5.17600E+01  5.17600E+01  -9.17000E+00  0.00000E-01
27      0      1      0      5.17600E+01  5.17600E+01  2.42000E+01  0.00000E-01
  
```

*** E M R C N I S A *** - MS DOS/VERSION 88.7 - (083088) 3/27/1990 21:49:55

OUTPUT CONTROL FOR LOAD CASE ID NO. 2

```

INTERNAL FORCE AND STRAIN ENERGY KEY ... (KELFR)= 1
REACTION FORCE KEY ..... (KRCTN)= 1
STRESS COMPUTATION KEY ..... (KSTR)= 0
STRAIN COMPUTATION KEY ..... (KSTN)= 0
ELEMENT STRESS/STRAIN OUTPUT OPTIONS ... (LQ1)= 0
NODAL STRESSES OUTPUT OPTIONS ..... (LQ2)= 0
DISPLACEMENT OUTPUT OPTIONS ..... (LQ7)= 0
STRESS FREE TEMPERATURE ..... (TSFRE)= 0.00000E-01
  
```

*** E M R C N I S A *** - MS DOS/VERSION 88.7 - (083088) 3/27/1990 21:49:55

STEWART TECHNOLOGY ASSOCIATES - LIFTBOAT ANALYSIS
NISA Finite Element Analysis Results For 65 feet Water Depth
70 knot wind, 20 foot wave height, 10 seconds period, 2 knot current
Page 6

CONCENTRATED NODAL FORCE AND MOMENT DATA (*CFORCE DATA GROUP)

```

-----
NODE NO. LABEL FORCE VALUE LASTNOD INC LFN
  200 FX 1.33000E+01 200 : :
  200 FY 3.51200E+01 200 : :
*** E M R C N I S A *** - MS DOS/VERSION 88.7 - (083088) 3/27/1990 21:49:55

```

LOAD COMBINATION DATA (ID= 3)

```

KEY TO COMBINE DISPLACEMENT ..... :
KEY TO COMBINE AVERAGED NODAL STRESS ..... :
KEY TO COMBINE ELEMENT FORCES AND STRAIN ENERGY ..... :

```

LOAD CASE ID NO.	SCALING FACTOR
1	1.000000
2	1.000000

```

TOTAL NO. OF LOAD CASES TO BE COMBINED= 2
*** E M R C N I S A *** - MS DOS/VERSION 88.7 - (083088) 3/27/1990 21:49:55

```

SELECTIVE PRINTOUT CONTROL PARAMETERS (*PRINTCNL DATA GROUP)

OUTPUT TYPE -- SET NUMBERS (NEGATIVE MEANS NONE, ZERO MEANS ALL)

```

LOAD VECTOR -1
ELEMENT INTERNAL FORCES 0
ELEMENT STRAIN ENERGY -1
RIGID LINK FORCES -1
REACTIONS 0
DISPLACEMENTS 0
ELEMENT STRESSES 0
AVERAGED NODAL STRESSES -1
*** E M R C N I S A *** - MS DOS/VERSION 88.7 - (083088) 3/27/1990 21:50:14

```

PROCESS NODAL COORDINATES DATA

PROCESS *E1 (ELEMENT CONNECTIVITY) DATA

```

TOTAL NUMBER OF ELEMENTS .....= 45
TOTAL NUMBER OF NODES .....= 33
TOTAL NUMBER OF ACTIVE NODES .....= 31
LARGEST NODE NUMBER .....= 200

```

```

MINIMUM X-COORD = 0.00000E+00 MAXIMUM X-COORD = 0.66000E+02
MINIMUM Y-COORD = -0.25000E+02 MAXIMUM Y-COORD = 0.25000E+02
MINIMUM Z-COORD = -0.58000E+02 MAXIMUM Z-COORD = 0.37000E+02

```

PROCESS *I1 (COUPLED DISPLACEMENT) DATA

WAVE FRONT STATUS BEFORE MINIMIZATION

```

-----
MAXIMUM WAVE FRONT .....= 118
RMS WAVE FRONT .....= 70
AVERAGE WAVE FRONT .....= 63
TOTAL NO. OF DOF IN MODEL .....= 168
(EXCLUDING SLAVE DOFS.)
WAVE FRONT STATUS AFTER MINIMIZATION (ITERATION NO. 1)
-----
MAXIMUM WAVE FRONT .....= 40
RMS WAVE FRONT .....= 25
AVERAGE WAVE FRONT .....= 24
TOTAL NO. OF DOF IN MODEL .....= 168
(EXCLUDING SLAVE DOFS.)
WAVE FRONT STATUS AFTER MINIMIZATION (ITERATION NO. 2)

```

STEWART TECHNOLOGY ASSOCIATES - LIFTBOAT ANALYSIS
NISA Finite Element Analysis Results For 65 feet Water Depth
70 knot wind, 20 foot wave height, 10 seconds period, 2 knot current
Page 7

```

-----
MAXIMUM WAVE FRONT ..... = 40
RMS WAVE FRONT ..... = 25
AVERAGE WAVE FRONT ..... = 24
TOTAL NO. OF DOF IN MODEL ... = 168
(EXCLUDING SLAVE DOFS.)
WAVE FRONT STATUS AFTER MINIMIZATION (ITERATION NO. 3 )
-----
MAXIMUM WAVE FRONT ..... = 40
RMS WAVE FRONT ..... = 25
AVERAGE WAVE FRONT ..... = 24
TOTAL NO. OF DOF IN MODEL ... = 168
(EXCLUDING SLAVE DOFS.)

```

```

***** WAVE FRONT MINIMIZATION WAS SUCCESSFUL, ITERATION NO. 1 IS SELECTED
WAVE FRONT PARAMETERS ARE-
MAXIMUM WAVE FRONT= 40
RMS WAVE FRONT = 25
AVERAGE WAVE FRONT= 24

```

PROCESS *SPOISP (SPECIFIED DISPLACEMENT) DATA FOR LOAD CASE ID NO. 1

```

TOTAL NUMBER OF VALID DOFS IN MODEL ..... = 168
TOTAL NUMBER OF UNCONSTRAINED DOFS ..... = 159
TOTAL NUMBER OF CONSTRAINED DOFS ..... = 9
TOTAL NUMBER OF SLAVES IN MPC EQS ..... = 0
*** E M R C N I S A *** - MS DOS/VERSION 88.7 - (083088) 3/27/1990 21:50:37

```

```

*** WAVE FRONT SOLUTION PARAMETERS ***
MAXIMUM WAVEFRONT (MAXPA) = 40
R.M.S. WAVEFRONT = 24
AVERAGE WAVEFRONT = 22
LARGEST ELEMENT MATRIX RANK USED (LVMAX) = 12
TOTAL NUMBER OF DEGREES OF FREEDOM = 159
ESTIMATED NUMBER OF RECORDS ON FILE 30 = 1

```

```

3 **WARNING - HIGH ROUND OFF OR NEGATIVE PIVOT ( CRIT,PIVOT = 0.6804640E+07 0.1347929E+02 ) AT ELEMENT 27 **
3 **WARNING - HIGH ROUND OFF OR NEGATIVE PIVOT ( CRIT,PIVOT = 0.2507758E+07 0.3541367E+02 ) AT ELEMENT 27 **
*** E M R C N I S A *** - MS DOS/VERSION 88.7 - (083088) 3/27/1990 21:51:46

```

***** STRAIN ENERGY CALCULATIONS *****

LOAD CASE ID NO. 1

```

**** TOTAL STRAIN ENERGY = 3.990220E+01
**** TOTAL WORK DONE BY EQV. NODAL FORCES = 3.990220E+01
*** E M R C N I S A *** - MS DOS/VERSION 88.7 - (083088) 3/27/1990 21:51:46

```

***** REACTION FORCES AND MOMENTS AT NODES *****

LOAD CASE ID NO. 1

NODE	FX	FY	FZ	MX	MY	MZ
113	-9.32905E+00	-2.21252E+01	-7.97559E+01	0.00000E-01	0.00000E-01	0.00000E-01
114	-6.28144E+00	-2.23088E+01	5.97891E+01	0.00000E-01	0.00000E-01	0.00000E-01
115	-9.84951E+00	-2.29661E+01	1.99669E+01	0.00000E-01	0.00000E-01	0.00000E-01

SUMMATION OF REACTION FORCES IN GLOBAL DIRECTIONS

```

-----
FX FY FZ
*** E M R C N I S A *** - MS DOS/VERSION 88.7 - (083088) 3/27/1990 21:51:46
-2.546000E+01 -5.740000E-01 -1.802469E-10

```

***** DISPLACEMENT SOLUTION *****

STEWART TECHNOLOGY ASSOCIATES - LIFTBOAT ANALYSIS
NISA Finite Element Analysis Results For 65 feet Water Depth
70 knot wind, 20 foot wave height, 10 seconds period, 2 knot current
Page 8

LOAD CASE ID NO. 1						
NODE	UX	UY	UZ	ROTX	ROTY	ROTZ
1	6.83621E-01	1.20865E+00	3.92504E-03	-1.38864E-04	2.24485E-05	5.76075E-03
2	5.39598E-01	1.20866E+00	4.95935E-04	-1.37024E-04	2.32435E-05	5.76095E-03
4	3.95573E-01	1.20865E+00	-2.94159E-03	-1.39428E-04	2.40810E-05	5.76085E-03
6	4.67586E-01	1.39875E+00	-1.98603E-03	-1.40886E-04	2.37502E-05	5.76059E-03
8	5.39599E-01	1.58884E+00	-9.81965E-04	-1.42954E-04	2.28088E-05	5.76038E-03
10	6.11617E-01	1.39875E+00	1.48886E-03	-1.40101E-04	2.38525E-05	5.76054E-03
13	6.83939E-01	1.21060E+00	3.94351E-03	-1.38924E-04	2.24096E-05	5.76079E-03
14	3.95909E-01	1.21061E+00	-2.95517E-03	-1.39389E-04	2.38275E-05	5.76071E-03
16	5.39921E-01	1.59084E+00	-9.87431E-04	-1.42210E-04	2.27059E-05	5.76101E-03
32	6.72833E-01	1.20962E+00	3.63784E-03	-1.39099E-04	2.24485E-05	5.76075E-03
34	4.06687E-01	1.20962E+00	-2.65917E-03	-1.39604E-04	2.40810E-05	5.76085E-03
36	5.39757E-01	1.57889E+00	-9.32780E-04	-1.42954E-04	2.28677E-05	5.76038E-03
101	6.83621E-01	1.20865E+00	3.14338E-03	-1.77651E-03	5.64587E-04	5.76075E-03
102	3.95573E-01	1.20865E+00	-2.35644E-03	-1.76225E-03	4.75377E-04	5.76085E-03
103	5.39599E-01	1.58884E+00	-7.86943E-04	-2.17771E-03	7.65990E-04	5.76038E-03
104	6.83939E-01	1.21060E+00	3.39342E-03	4.04622E-04	-3.24631E-04	5.76075E-03
105	3.95909E-01	1.21061E+00	-2.54388E-03	3.99141E-04	-1.42438E-04	5.76085E-03
106	5.39921E-01	1.59084E+00	-8.49541E-04	6.07241E-04	-2.23851E-04	5.76038E-03
113	0.00000E-01	0.00000E-01	0.00000E-01	-2.07546E-02	1.16906E-02	5.76075E-03
114	0.00000E-01	0.00000E-01	0.00000E-01	-2.08001E-02	7.04968E-03	5.76085E-03
115	0.00000E-01	0.00000E-01	0.00000E-01	-2.75764E-02	9.26344E-03	5.76038E-03
118	6.76477E-01	1.20130E+00	3.39342E-03	4.04622E-04	-3.24631E-04	5.76075E-03
117	3.92633E-01	1.20143E+00	-2.54388E-03	3.99141E-04	-1.42438E-04	5.76085E-03
118	5.34772E-01	1.57687E+00	-8.49541E-04	6.07241E-04	-2.23851E-04	5.76038E-03
119	6.86036E-01	1.21344E+00	3.39342E-03	-7.04956E-05	-2.32602E-06	5.76075E-03
120	3.96822E-01	1.21341E+00	-2.54388E-03	-8.86070E-05	1.20156E-05	5.76085E-03
121	5.41492E-01	1.59471E+00	-8.49541E-04	-8.89961E-05	6.04343E-06	5.76038E-03
129	6.75090E-01	1.21344E+00	3.63784E-03	-3.24055E-05	-2.32602E-06	5.76075E-03
130	4.07767E-01	1.21341E+00	-2.65917E-03	-6.00528E-05	1.20156E-05	5.76085E-03
131	5.41492E-01	1.58377E+00	-9.32780E-04	-8.89961E-05	-3.49239E-06	5.76038E-03
200	5.39853E-01	1.36527E+00	-1.12761E-04	-1.38717E-04	2.23866E-05	5.76093E-03

LARGEST MAGNITUDES OF DISPLACEMENT VECTOR =

NODE	UX	UY	UZ	ROTX	ROTY	ROTZ
106	6.86036E-01	1.59471E+00	3.34351E-03	-2.75764E-02	1.16906E-02	5.76101E-03
119	119	121	13	115	113	16

E M R C N I S A *** - MS DOS/VERSION 88.7 - (083088) 3/27/1990 21:52:9

STRESS RESULTANTS FOR LINE ELEMENTS - LOAD CASE ID NO. 1

MINIMUM/MAXIMUM LOCAL RESULTANTS

ELE NO.	MIN/MAX AXIAL	ELE NO.	MIN/MAX Y-SHEAR	ELE NO.	MIN/MAX Z-SHEAR	ELE NO.	MIN/MAX TORQUE	ELE NO.	MIN/MAX Y-MOMENT	ELE NO.	MIN/MAX Z-MOMENT
19	-7.97559E+01	28	-8.17146E+01	31	-7.97559E+01	202	-1.62039E+02	20	-1.17764E+03	27	-1.14400E+03
19	7.97559E+01	28	8.17146E+01	31	7.97559E+01	202	1.62039E+02	19	1.17764E+03	28	1.14400E+03

*** E M R C N I S A *** - MS DOS/VERSION 88.7 - (083088) 3/27/1990 21:52:25

TIME LOG IN SECONDS

LOAD CASE ID NO. 1	
INPUT (READ,GENERATE)	14.640
DATA SORTING AND CHECKING	4.050
REORDERING OF ELEMENTS	10.050
FORM ELEMENT MATRICES	34.340
FORM GLOBAL LOAD VECTOR	2.170
MATRIX TRANSFORMATION DUE TO MPC	0.000
PRE-FRONT	2.040
SOLUTION OF SYSTEM EQUATIONS	12.670
INTERNAL FORCES AND REACTIONS	13.390
STRESS CALCULATION	15.490
TOTAL CPU	108.840

*** E M R C N I S A *** - MS DOS/VERSION 88.7 - (083088) 3/27/1990 21:52:56

***** STRAIN ENERGY CALCULATIONS *****

LOAD CASE ID NO. 2

**** TOTAL STRAIN ENERGY	= 1.957737E+01
**** TOTAL WORK DONE BY EQV. NODAL FORCES	= 0.000000E-01

E M R C N I S A *** - MS DOS/VERSION 88.7 - (083088) 3/27/1990 21:52:56

***** REACTION FORCES AND MOMENTS AT NODES *****

STEWART TECHNOLOGY ASSOCIATES - LIFTBOAT ANALYSIS
NISA Finite Element Analysis Results For 65 feet Water Depth
70 knot wind, 20 foot wave height, 10 seconds period, 2 knot current
Page 9

LOAD CASE ID NO. 2						
NODE	FX	FY	FZ	MX	MY	MZ
113	-5.75123E+00	-1.10538E+01	-7.94805E+01	0.00000E-01	0.00000E-01	0.00000E-01
114	-2.28901E+00	-1.10530E+01	5.95385E+01	0.00000E-01	0.00000E-01	0.00000E-01
115	-5.25977E+00	-1.30133E+01	1.99419E+01	0.00000E-01	0.00000E-01	0.00000E-01

SUMMATION OF REACTION FORCES IN GLOBAL DIRECTIONS

```

*** E M R C   N I S A   ***
      FX              FY              FZ
-1.33000E+01  -3.51200E+01  -1.029150E-10
- MS DOS/VERSION 88.7  - (083088)  3/27/1990  21:52:56
  
```

***** DISPLACEMENT SOLUTION *****

LOAD CASE ID NO. 2						
NODE	UX	UY	UZ	ROTX	ROTY	ROTZ
1	5.36654E-01	7.97700E-01	3.91200E-03	-1.38320E-04	2.24973E-05	6.43473E-03
2	3.75782E-01	7.97708E-01	4.95464E-04	-1.36534E-04	2.32759E-05	6.43493E-03
4	2.14905E-01	7.97695E-01	-2.92975E-03	-1.38907E-04	2.40894E-05	6.43494E-03
6	2.95346E-01	1.01003E+00	-1.98163E-03	-1.40616E-04	2.38497E-05	6.43438E-03
8	3.75783E-01	1.22235E+00	-9.80913E-04	-1.43034E-04	2.27601E-05	6.43383E-03
10	4.56225E-01	1.01004E+00	1.48380E-03	-1.39806E-04	2.07016E-05	6.43433E-03
13	5.36973E-01	7.99644E-01	3.93027E-03	-1.38388E-04	2.24319E-05	6.43489E-03
14	2.15241E-01	7.99646E-01	-2.94324E-03	-1.38868E-04	2.38352E-05	6.43496E-03
16	3.76104E-01	1.22435E+00	-9.86311E-04	-1.42162E-04	2.26572E-05	6.43440E-03
32	5.24586E-01	7.98663E-01	3.62591E-03	-1.38554E-04	2.24973E-05	6.43473E-03
34	2.27300E-01	7.98664E-01	-2.64839E-03	-1.39083E-04	2.40894E-05	6.43494E-03
36	3.75941E-01	1.21112E+00	-9.31829E-04	-1.43034E-04	2.28188E-05	6.43383E-03
101	5.36654E-01	7.97700E-01	3.13253E-03	-1.49106E-03	9.22893E-04	6.43473E-03
102	2.14905E-01	7.97695E-01	-2.34657E-03	-1.49154E-03	3.82258E-04	6.43494E-03
103	3.75783E-01	1.22235E+00	-7.85963E-04	-2.17986E-03	6.66424E-04	6.43383E-03
104	5.36973E-01	7.99644E-01	3.38171E-03	3.10562E-04	-3.09168E-04	6.43473E-03
105	2.15241E-01	7.99646E-01	-2.53322E-03	3.09950E-04	-1.08107E-04	6.43494E-03
106	3.76104E-01	1.22435E+00	-8.48482E-04	6.07915E-04	-1.90849E-04	6.43383E-03
113	0.00000E-01	0.00000E-01	0.00000E-01	-1.28155E-02	8.66727E-03	6.43473E-03
114	0.00000E-01	0.00000E-01	0.00000E-01	-1.28152E-02	3.46455E-03	6.43494E-03
115	0.00000E-01	0.00000E-01	0.00000E-01	-1.97030E-02	6.05500E-03	6.43383E-03
116	5.29862E-01	7.92501E-01	3.38171E-03	3.10562E-04	-3.09168E-04	6.43473E-03
117	2.12755E-01	7.92517E-01	-2.53322E-03	3.09950E-04	-1.08107E-04	6.43494E-03
118	3.71715E-01	1.21037E+00	-8.48482E-04	6.07915E-04	-1.90849E-04	6.43383E-03
119	5.38970E-01	8.01825E-01	3.38171E-03	-6.99192E-05	-1.15238E-06	6.43473E-03
120	2.15931E-01	8.01823E-01	-2.53322E-03	-8.80432E-05	1.44842E-05	6.43494E-03
121	3.77444E-01	1.22823E+00	-8.48482E-04	-8.90292E-05	5.92519E-06	6.43383E-03
129	5.26744E-01	8.01825E-01	3.62591E-03	-3.19606E-05	-1.15238E-06	6.43473E-03
130	2.28158E-01	8.01823E-01	-2.64839E-03	-5.96086E-05	1.44842E-05	6.43494E-03
131	3.77444E-01	1.21600E+00	-9.31829E-04	-8.90292E-05	-3.59874E-06	6.43383E-03
200	3.76045E-01	3.72476E-01	-1.30555E-04	-1.38123E-04	2.23330E-05	6.43504E-03

LARGEST MAGNITUDES OF DISPLACEMENT VECTOR =

```

      5.38970E-01  1.22823E+00  3.93027E-03  -1.97030E-02  8.66727E-03  6.43504E-03
AT NODE      119      121      13      115      113      200
*** E M R C   N I S A   ***
- MS DOS/VERSION 88.7  - (083088)  3/27/1990  21:53:19
  
```

STRESS RESULTANTS FOR LINE ELEMENTS - LOAD CASE ID NO. 2

MINIMUM/MAXIMUM LOCAL RESULTANTS

ELE NO.	MIN/MAX AXIAL	ELE NO.	MIN/MAX Y-SHEAR	ELE NO.	MIN/MAX Z-SHEAR	ELE NO.	MIN/MAX TORQUE	ELE NO.	MIN/MAX Y-MOMENT	ELE NO.	MIN/MAX Z-MOMENT
19	-7.94805E+01	28	-8.17976E+01	31	-7.94805E+01	202	1.03998E+02	25	-9.72731E+02	27	-1.14517E+03
19	7.94805E+01	28	8.17976E+01	31	7.94805E+01	202	1.89988E+02	19	9.72731E+02	28	1.14517E+03

*** E M R C N I S A ***
- MS DOS/VERSION 88.7 - (083088) 3/27/1990 21:53:32

T I M E L O G I N S E C O N D S

```

      LOAD CASE ID NO. 2
INPUT READ,GENERATE ) .....= 0.000
DATA SORTING AND CHECKING .....= 0.000
REORDERING OF ELEMENTS .....= 0.000
FORM ELEMENT MATRICES .....= 0.560
  
```

STEWART TECHNOLOGY ASSOCIATES - LIFTBOAT ANALYSIS
NISA Finite Element Analysis Results For 65 feet Water Depth
70 knot wind, 20 foot wave height, 10 seconds period, 2 knot current
Page 10

```
FORM GLOBAL LOAD VECTOR .....= 1.240
MATRIX TRANSFORMATION DUE TO MPC .....= 0.000
PRE-FRONT .....= 0.000
SOLUTION OF SYSTEM EQUATIONS .....= 4.820
INTERNAL FORCES AND REACTIONS .....= 12.690
STRESS CALCULATION .....= 13.350
TOTAL CPU .....= 32.660
```

*** E M R C N I S A *** - MS DOS/VERSION 88.7 - (083088) 3/27/1990 21:53:32

LOAD COMBINATION ID NO. 3

NUMBER OF LOAD CASES TO BE COMBINED = 2

LOAD CASE ID NO. SCALING FACTOR

1 1.000000
2 1.000000

*** E M R C N I S A *** - MS DOS/VERSION 88.7 - (083088) 3/27/1990 21:53:32

***** DISPLACEMENT SOLUTION *****

LOAD COMBINATION ID NO. 3

NODE	UX	UY	UZ	ROTX	ROTY	ROTZ
1	1.22027E+00	2.00635E+00	7.83704E-03	-2.77184E-04	4.49458E-05	1.21955E-02
2	9.15379E-01	2.00637E+00	9.91399E-04	-2.73558E-04	4.65194E-05	1.21959E-02
4	6.10478E-01	2.00634E+00	-5.87134E-03	-2.78335E-04	4.81703E-05	1.21958E-02
6	7.62932E-01	2.40878E+00	-3.96767E-03	-2.81502E-04	4.75999E-05	1.21950E-02
8	9.15382E-01	2.81118E+00	-1.96288E-03	-2.85988E-04	4.55689E-05	1.21942E-02
10	1.06784E+00	2.40879E+00	2.97266E-03	-2.79907E-04	4.15541E-05	1.21949E-02
13	1.22091E+00	2.01025E+00	7.87378E-03	-2.77313E-04	4.48415E-05	1.21957E-02
14	6.11150E-01	2.01025E+00	-5.89841E-03	-2.78257E-04	4.76627E-05	1.21957E-02
16	9.16025E-01	2.81519E+00	-1.97374E-03	-2.84372E-04	4.53630E-05	1.21954E-02
32	1.19742E+00	2.00828E+00	7.26376E-03	-2.77653E-04	4.49458E-05	1.21955E-02
34	6.33987E-01	2.00828E+00	-5.30756E-03	-2.78686E-04	4.81703E-05	1.21958E-02
36	9.15699E-01	2.79002E+00	-1.86461E-03	-2.85988E-04	4.56865E-05	1.21942E-02
101	1.22027E+00	2.00635E+00	6.27591E-03	-3.26757E-03	1.88748E-03	1.21955E-02
102	6.10478E-01	2.00634E+00	-4.70301E-03	-3.25379E-03	8.57634E-04	1.21958E-02
103	9.15382E-01	2.81118E+00	-1.57291E-03	-4.35757E-03	1.43241E-03	1.21942E-02
104	1.22091E+00	2.01025E+00	6.77513E-03	7.15184E-04	-6.33798E-04	1.21955E-02
105	6.11150E-01	2.01025E+00	-5.07711E-03	7.09090E-04	-2.50545E-04	1.21958E-02
106	9.16025E-01	2.81519E+00	-1.69802E-03	1.21516E-03	-4.14700E-04	1.21942E-02
113	0.00000E-01	0.00000E-01	0.00000E-01	-3.35704E-02	2.03579E-02	1.21955E-02
114	0.00000E-01	0.00000E-01	0.00000E-01	-3.36153E-02	1.05142E-02	1.21958E-02
115	0.00000E-01	0.00000E-01	0.00000E-01	-4.72794E-02	1.53184E-02	1.21942E-02
116	1.20633E+00	1.35380E+00	6.77513E-03	7.15184E-04	-6.33798E-04	1.21955E-02
117	6.05387E-01	1.39394E+00	-5.07711E-03	7.09090E-04	-2.50545E-04	1.21958E-02
118	9.08487E-01	2.78724E+00	-1.69802E-03	1.21516E-03	-4.14700E-04	1.21942E-02
119	1.22501E+00	2.01527E+00	6.77513E-03	-1.40415E-04	-3.47841E-06	1.21955E-02
120	6.12753E-01	2.01523E+00	-5.07711E-03	-1.76650E-04	2.64999E-05	1.21958E-02
121	9.18936E-01	2.82294E+00	-1.69802E-03	-1.78025E-04	1.19686E-05	1.21942E-02
129	1.20183E+00	2.01527E+00	7.26376E-03	-6.43661E-05	-3.47841E-06	1.21955E-02
130	6.35925E-01	2.01523E+00	-5.30756E-03	-1.19661E-04	2.64999E-05	1.21958E-02
131	9.18936E-01	2.79977E+00	-1.86461E-03	-1.78025E-04	-7.09113E-06	1.21942E-02
200	9.15699E-01	2.33774E+00	-2.25816E-04	-2.76840E-04	4.47210E-05	1.21960E-02

LARGEST MAGNITUDES OF DISPLACEMENT VECTOR =

AT NODE 119 121 13 115 113 200
1.22501E+00 2.82294E+00 7.87378E-03 -4.72794E-02 2.03579E-02 1.21960E-02

*** E M R C N I S A *** - MS DOS/VERSION 88.7 - (083088) 3/27/1990 21:53:32

***** INTERNAL FORCE CALCULATIONS *****

LOAD COMBINATION ID NO. 3

ELM. NO.	NODE	FX	FY	FZ	MX	MY	MZ
1	1	6.19372E+00	-1.51224E+01	-5.93940E+01	-1.20658E+03	-1.14997E+02	-1.13974E+02
2	2	-6.19372E+00	1.51224E+01	5.93940E+01	-5.28267E+02	1.14997E+02	-4.08685E+01
2	2	1.05672E+01	2.29379E+01	-6.45182E+01	-3.59682E+02	-1.20651E+02	-1.23566E+02
4	4	-1.05672E+01	-2.29379E+01	6.45182E+01	-1.25327E+03	1.20651E+02	-1.40613E+02
3	4	-8.21110E+00	7.39715E+00	9.63724E+00	1.12222E+02	-1.07043E+02	1.25238E+01
6	6	8.21110E+00	-7.39715E+00	-9.63724E+00	-2.32688E+02	-2.10986E+02	1.62294E+02
4	6	-1.18060E+01	1.18200E+01	3.02725E+00	2.31284E+02	1.02495E+02	1.71440E+02
8	8	1.18060E+01	-1.18200E+01	-3.02725E+00	-2.69124E+02	-2.02394E+02	7.10440E+01

STEWART TECHNOLOGY ASSOCIATES - LIFTBOAT ANALYSIS
NISA Finite Element Analysis Results For 65 feet Water Depth
70 knot wind, 20 foot wave height, 10 seconds period, 2 knot current
Page 11

5	8	-1.87887E+01	-1.49984E+01	2.48065E+01	-5.00215E+02	6.97264E-02	8.64784E+01
	10	1.87887E+01	1.49984E+01	-2.48065E+01	1.90135E+02	1.21349E+02	1.73610E+02
6	10	4.53071E+00	-4.22518E+00	2.85354E+01	-3.07999E+02	2.65317E+02	5.67536E+01
	1	-4.53071E+00	4.22518E+00	-2.85354E+01	-4.86932E+01	6.76351E+02	1.39311E+02
7	13	-4.97543E+00	-2.91858E+00	-2.62749E+01	-6.12724E+02	-1.03085E+02	1.24962E+02
	14	4.97543E+00	2.91858E+00	2.62749E+01	-7.01019E+02	1.03085E+02	1.23809E+02
8	14	6.60695E+00	-4.60064E+00	3.06049E+00	1.31140E+02	-1.22058E+01	-6.07836E+01
	16	-6.60695E+00	4.60064E+00	-3.06049E+00	-2.07652E+02	-1.89786E+02	-7.76846E+01
9	16	3.77724E+00	4.32960E+00	1.19971E+01	-3.40384E+02	4.29662E+02	-1.04520E+02
	13	-3.77724E+00	-4.32960E+00	-1.19971E+01	4.04560E+01	3.52147E-02	-8.68020E+01
10	13	-2.27692E+00	1.95454E+01	-2.94464E-01	-1.73262E+02	-9.96932E+01	4.82574E-01
	2	2.27692E+00	-1.95454E+01	2.94464E-01	4.39536E+02	1.31570E+02	5.64404E+01
11	2	-6.65035E+00	-1.85149E+01	-5.17022E+00	4.48414E+02	-1.25916E+02	1.07994E+02
	14	6.65035E+00	1.85149E+01	5.17022E+00	-3.18460E+02	3.28109E+01	5.82651E+01
12	14	-4.41298E+00	2.92113E-01	-1.89924E+00	1.84059E+02	7.73661E+01	3.32671E+01
	6	4.41298E+00	-2.92113E-01	1.89924E+00	-1.56229E+02	4.70905E+01	-7.87890E+01
13	6	-8.18040E-01	-4.13072E+00	4.71076E+00	1.57633E+02	6.14011E+01	-1.08880E+02
	16	8.18040E-01	4.13072E+00	-4.71076E+00	-1.58687E+02	-2.28309E+02	-3.76596E+01
14	16	9.00783E+00	7.98938E+00	8.25770E+00	-2.42318E+02	3.18578E+02	-2.96200E+01
	10	-9.00783E+00	-7.98938E+00	-8.25770E+00	2.50948E+02	-1.72184E+02	-1.21432E+02
15	10	-1.43116E+01	-2.78385E+00	4.52878E+00	-1.33083E+02	-2.14483E+02	-1.08932E+02
	13	1.43116E+01	2.78385E+00	-4.52878E+00	1.15447E+02	1.63570E+02	2.19044E+01
16	1	4.05208E-09	7.24318E-09	1.59236E+02	3.02549E+02	4.84000E-08	7.57325E-09
	32	-4.05208E-09	-7.24318E-09	-1.59236E+02	1.99254E-08	-2.32615E-09	1.42038E-08
17	4	4.35759E-09	-6.05202E-09	-1.19328E+02	2.26722E+02	1.13894E-08	4.41105E-10
	34	-4.35759E-09	6.05202E-09	1.19328E+02	-1.42535E-11	7.50333E-12	-2.08058E-09
18	8	-1.82419E-09	-1.79591E-09	-3.99088E+01	9.23873E-08	-7.58266E+01	9.80731E-09
	36	1.82419E-09	1.79591E-09	3.99088E+01	5.29224E-09	4.79291E-10	2.51578E-09
19	113	-1.50803E+01	-3.31789E+01	-1.59236E+02	-6.77050E-14	3.11105E-13	9.22873E-15
	101	7.04026E+00	1.19489E+01	1.59236E+02	2.15037E+03	-1.03569E+03	-9.22873E-15
20	101	7.39782E-01	1.31987E+02	-1.59236E+02	-2.15037E+03	1.03569E+03	-1.67422E-13
	119	-7.39782E-01	-1.31987E+02	1.59236E+02	1.22646E+03	-5.17847E+02	1.67422E-13
21	119	7.39782E-01	1.31987E+02	-1.54099E-13	-9.23911E+02	5.17847E+02	-4.89608E-13
	104	-7.39782E-01	-1.31987E+02	1.54099E-13	1.48971E-11	2.49100E-11	4.89608E-13
22	104	-3.22550E-13	1.13886E-13	-1.34615E-14	-6.90302E-12	-7.70562E-12	-1.29896E-14
	116	3.22550E-13	-1.13886E-13	1.34615E-14	-5.36034E-12	8.21565E-15	1.29896E-14
23	114	-8.57045E+00	-3.33618E+01	1.19328E+02	-8.37309E-13	-6.66567E-14	1.89709E-14
	102	3.20450E-01	1.13918E+01	-1.19328E+02	2.13964E+03	-4.55220E+02	-1.89709E-14
24	102	3.25157E+01	1.36637E+02	1.19328E+02	-2.13964E+03	4.55220E+02	6.31939E-13
	120	-3.25157E+01	-1.36637E+02	-1.19328E+02	1.18318E+03	-2.27610E+02	-6.31939E-13
25	120	3.25157E+01	1.36637E+02	4.43534E-14	-9.56460E+02	2.27610E+02	1.77192E-13
	105	-3.25157E+01	-1.36637E+02	-4.43534E-14	-2.51365E-11	6.69645E-13	-1.77192E-13
26	105	2.47638E-14	4.24893E-13	1.62370E-14	-6.43961E-12	-5.25038E-12	-3.66374E-14
	117	-2.47638E-14	-4.24893E-13	-1.62370E-14	1.54006E-12	3.21965E-15	3.66374E-14
27	115	-1.51093E+01	-3.59793E+01	3.99088E+01	1.63258E-13	1.83225E-13	1.78191E-14
	103	5.93927E+00	1.17793E+01	-3.99088E+01	2.28917E+03	-9.97295E+02	-1.78191E-14
28	103	6.58192E+01	1.63512E+02	3.99088E+01	-2.28917E+03	9.97295E+02	7.12097E-13
	121	-6.58192E+01	-1.63512E+02	-3.99088E+01	1.14459E+03	-5.36561E+02	-7.12097E-13
29	121	6.58192E+01	1.63512E+02	-2.06779E-14	-1.14459E+03	4.60734E+02	-1.97398E-13
	106	-6.58192E+01	-1.63512E+02	2.06779E-14	-1.04854E-11	8.76813E-13	1.97398E-13
30	106	-8.76300E-14	-5.07693E-13	-6.69603E-15	2.36179E-11	1.71626E-12	4.62963E-14
	118	8.76300E-14	5.07693E-13	6.69603E-15	5.05151E-15	9.41608E-15	-4.62963E-14
31	119	-3.19198E-11	4.66116E-11	-1.59236E+02	-3.02549E+02	-1.08962E-16	4.25895E-11
	129	3.19198E-11	-4.66116E-11	1.59236E+02	2.65760E-15	1.08962E-16	6.99583E-11
32	120	-1.47471E-12	1.00101E-10	1.19328E+02	-2.26722E+02	1.25074E-15	6.70619E-12
	130	1.47471E-12	-1.00101E-10	-1.19328E+02	5.10564E-14	-1.25074E-15	-1.78701E-12

STEWART TECHNOLOGY ASSOCIATES - LIFTBOAT ANALYSIS
NISA Finite Element Analysis Results For 65 foot Water Depth
70 knot wind, 20 foot wave height, 10 seconds period, 2 knot current
Page 12

33	121	-8.04903E-11	-2.05584E-11	3.99088E+01	-9.92262E-16	7.58266E+01	6.25722E-12
	131	8.04903E-11	2.05584E-11	-3.99088E+01	9.92262E-16	6.76108E-16	-5.27667E-12
40	1	-8.26315E+01	-1.33039E+02	-6.13070E+01	9.52726E+02	-5.61354E+02	-2.53370E+01
	13	8.26815E+01	1.33039E+02	6.13070E+01	9.09819E+02	-5.96187E+02	2.53370E+01
41	4	-1.40579E+01	-1.32488E+02	4.51722E+01	9.14329E+02	-1.36084E+01	-1.53754E+01
	14	1.40579E+01	1.32488E+02	-4.51722E+01	9.40505E+02	-1.83202E+02	-1.53754E+01
42	9	-6.47758E+01	-1.48473E+02	1.81295E+01	7.69340E+02	-4.19044E+02	-1.57522E+02
	16	6.47758E+01	1.48473E+02	-1.81295E+01	1.30928E+03	-4.87818E+02	1.57522E+02
200	13	-1.19853E+01	-1.61327E+01	-1.82118E+01	-2.79736E+02	2.73248E+02	-8.58845E+01
	200	1.19853E+01	1.61327E+01	1.82118E+01	-2.24602E+02	2.53449E+02	-4.87754E+01
201	14	4.63805E+00	-1.29760E+01	1.25658E+01	-2.36224E+02	-1.78538E+01	-1.39182E+02
	200	-4.63805E+00	1.29760E+01	-1.25658E+01	-1.17368E+02	-3.34518E+02	-9.41812E+01
202	200	5.95278E+00	6.01126E+00	-5.64597E+00	3.41970E+02	8.10686E+01	1.42958E+02
	16	-5.95278E+00	-6.01126E+00	5.64597E+00	-3.60244E+02	1.57673E+02	9.19624E+01

*** E M R C N I S A *** - MS DOS/VERSION 88.7 - (083088) 3/27/1990 21:53 32

STRESS RESULTANTS FOR LINE ELEMENTS - LOAD COMBINATION ID NO. 3

ELE NUMBER	ELE NKTYP	NODE NUMBER	FORCE		SHEAR		TORQUE	MOMENT	
			AXIAL	LOCAL-Y	LOCAL-Z	AXIAL	LOCAL-Y	LOCAL-Z	
1	12	1	-1.51224E+01	-6.19372E+00	-6.93940E+01	-1.14997E+02	1.20658E+03	-1.13974E+02	
		2	1.51224E+01	6.19372E+00	6.93940E+01	1.14997E+02	5.28267E+02	-4.08689E+01	
2	12	2	2.29379E+01	-1.05672E+01	-6.45182E+01	-1.20651E+02	3.59682E+02	-1.23566E+02	
		4	-2.29379E+01	1.05672E+01	6.45182E+01	1.20651E+02	1.25327E+03	-1.40613E+02	
3	12	4	-1.02990E+01	4.00892E+00	9.63724E+00	1.42863E+02	-6.03499E+01	1.25238E+02	
		6	1.02990E+01	-4.00892E+00	-9.63724E+00	-1.42863E+02	-2.79730E+02	1.62294E+01	
4	12	6	-1.52275E+01	6.87155E+00	3.02725E+00	1.79981E+02	1.77776E+02	1.71440E+02	
		8	1.52275E+01	-6.87155E+00	-3.02725E+00	-1.79981E+02	-2.84602E+02	7.10440E+01	
5	12	8	2.28833E+01	7.37044E+00	2.48065E+01	2.20791E+02	-8.29243E+02	8.64784E+01	
		10	-2.28833E+01	-7.37044E+00	-2.48065E+01	-2.20791E+02	-4.61301E+01	1.73610E+02	
6	12	10	-2.74026E+00	5.55612E+00	2.85354E+01	1.94046E+02	-3.57215E+02	5.67536E+01	
		1	2.74026E+00	-5.55612E+00	-2.85354E+01	-1.94046E+02	-6.49744E+02	1.39311E+02	
7	12	13	-2.91858E+00	4.97543E+00	-2.62749E+01	-1.03085E+02	6.12724E+02	1.24962E+02	
		14	2.91858E+00	-4.97543E+00	2.62749E+01	1.03085E+02	7.01019E+02	1.23809E+02	
8	12	14	7.80822E+00	-1.96197E+00	3.06049E+00	1.26960E+02	3.50388E+01	-6.07836E+01	
		16	-7.80822E+00	1.96197E+00	-3.06049E+00	-1.26960E+02	-2.51036E+02	-7.76848E+01	
9	12	16	-5.06599E+00	-2.71086E+00	1.19971E+01	1.66115E+02	-5.22375E+02	-1.04520E+02	
		13	5.06599E+00	2.71086E+00	-1.19971E+01	-1.66115E+02	-3.24335E+02	-8.68020E+01	
10	12	13	1.71973E+01	2.27692E+00	9.29302E+00	-8.72187E+01	1.73262E+02	-4.82894E+01	
		2	-1.71973E+01	-2.27692E+00	-9.29302E+00	8.72187E+01	-4.39536E+02	1.35303E+02	
11	12	2	-1.86806E+01	6.65035E+00	4.53541E+00	-5.70962E+01	-4.48414E+02	1.55748E+02	
		14	1.86806E+01	-6.65035E+00	-4.53541E+00	5.70962E+01	3.18460E+02	3.48051E+01	
12	12	14	-3.23177E+00	-1.29002E+00	-3.32540E+00	1.22251E+02	1.37548E+02	8.42908E+01	
		6	3.23177E+00	1.29002E+00	3.32540E+00	-1.22251E+02	-1.13033E+01	-1.33265E+02	
13	12	6	2.38620E+00	-4.15265E+00	4.12126E+00	7.66534E+01	1.13258E+02	-1.47546E+02	
		16	-2.38620E+00	4.15265E+00	-4.12126E+00	-7.66534E+01	-2.69716E+02	-1.01041E+01	
14	12	16	-1.35059E+01	-4.28053E+00	3.52560E+00	1.16662E+02	-3.83757E+02	1.44179E+01	
		10	1.35059E+01	4.28053E+00	-3.52560E+00	-1.16662E+02	2.49912E+02	-1.76923E+02	
15	12	10	1.50270E+01	-2.46621E+00	-1.08957E+00	1.46132E+02	1.53434E+02	-1.75168E+02	
		13	-1.50270E+01	2.46621E+00	1.08957E+00	-1.46132E+02	-1.12070E+02	8.15409E+01	
16	12	1	1.53676E+02	-3.96119E-09	4.17121E+01	2.00328E-09	-3.02549E+02	-7.65085E-08	
		32	-1.53676E+02	3.96119E-09	-4.17121E+01	-2.00328E-09	2.98131E-08	1.53196E-08	
17	12	4	-1.15161E+02	4.41153E-09	-3.12579E+01	2.05921E-09	2.26722E+02	1.33116E-08	
		34	1.15161E+02	-4.41153E-09	3.12579E+01	-2.05921E-09	-3.12836E+09	8.06040E-11	
18	12	8	-3.85152E+01	-1.31739E-08	-1.04541E+01	2.89799E-09	7.58266E+01	-6.71682E-08	
		36	3.85152E+01	1.31739E-08	1.04541E+01	-2.89799E-09	-1.30740E-08	-4.70249E-08	
19	12	113	-1.59236E+02	-1.50803E+01	-3.31789E+01	9.22873E-15	1.05675E-12	5.87957E-13	
		101	1.59236E+02	7.04028E+00	1.19489E+01	-9.22873E-15	2.15037E-03	-1.03569E+03	
20	12	101	-1.59236E+02	7.39782E+01	1.31987E+02	-1.67422E-13	-2.15037E+03	1.03569E+03	

STEWART TECHNOLOGY ASSOCIATES - LIFTBOAT ANALYSIS
NISA Finite Element Analysis Results For 65 feet Water Depth
70 knot wind, 20 foot wave height, 10 seconds period, 2 knot current
Page 13

		- 119	1.59236E+02	-7.39782E+01	-1.31987E+02	1.57422E-13	1.22646E+03	-5.17847E+02		
21	12	119	-1.54099E-13	7.39782E+01	1.31987E+02	-4.89608E-13	-9.23911E+02	5.17847E+02		
		104	1.54099E-13	-7.39782E+01	-1.31987E+02	4.89608E-13	1.64965E-11	1.56096E-11		
22	12	104	-1.34615E-14	-1.81537E-13	4.64317E-13	-1.29896E-14	-7.82636E-12	-1.01193E-11		
		116	1.34615E-14	1.81537E-13	-4.64317E-13	1.29896E-14	7.82636E-12	-1.23926E-12		
23	12	114	1.19328E+02	-8.57045E+00	-3.33618E+01	1.89709E-14	-6.32820E-13	2.02113E-13		
		102	-1.19328E+02	8.57045E+00	3.33618E+01	-1.89709E-14	6.32820E-13	-2.02113E-13		
24	12	102	1.19328E+02	3.25157E+01	1.36637E+02	6.31939E-13	-2.13964E+03	4.55220E+02		
		- 120	-1.19328E+02	-3.25157E+01	-1.36637E+02	-6.31939E-13	2.13964E+03	-4.55220E+02		
25	12	- 120	4.43534E-14	3.25157E+01	1.36637E+02	1.77192E-13	-9.56460E+02	2.27610E+02		
		105	-4.43534E-14	-3.25157E+01	-1.36637E+02	-1.77192E-13	9.56460E+02	-2.27610E+02		
26	12	105	1.62370E-14	5.40713E-15	-7.62237E-13	-3.66374E-14	5.50868E-12	-5.61276E-12		
		117	-1.62370E-14	-5.40713E-15	7.62237E-13	3.66374E-14	-5.50868E-12	5.61276E-12		
27	12	115	3.99088E+01	-3.59793E+01	1.51093E+01	1.78191E-14	1.83225E-13	-1.63258E-13		
		103	-3.99088E+01	3.59793E+01	-1.51093E+01	-1.78191E-14	-1.83225E-13	1.63258E-13		
28	12	103	3.99088E+01	1.63512E+02	-6.58192E+01	7.12097E-13	-9.97295E+02	2.28917E+03		
		- 121	-3.99088E+01	-1.63512E+02	6.58192E+01	-7.12097E-13	9.97295E+02	-2.28917E+03		
29	12	- 121	2.06779E-14	1.63512E+02	-6.58192E+01	-1.97398E-13	4.60734E+02	1.14459E+03		
		106	-2.06779E-14	-1.63512E+02	6.58192E+01	1.97398E-13	-4.60734E+02	-1.14459E+03		
30	12	106	-6.69603E-15	-5.07693E-13	8.76300E-14	4.62963E-14	1.71626E-12	-2.36179E-11		
		118	6.69603E-15	5.07693E-13	-8.76300E-14	-4.62963E-14	-1.71626E-12	2.36179E-11		
31	12	119	4.66116E-11	3.19198E-11	-1.59236E+02	-1.08962E-16	3.02549E+02	4.25895E-11		
		129	-4.66116E-11	-3.19198E-11	1.59236E+02	1.08962E-16	-3.02549E+02	-4.25895E-11		
32	12	120	-1.00101E-10	-1.47471E-12	1.19328E+02	-1.25074E-15	-2.26722E+02	6.70619E-12		
		130	1.00101E-10	1.47471E-12	-1.19328E+02	1.25074E-15	2.26722E+02	-6.70619E-12		
33	12	121	8.04903E-11	2.05584E-11	3.99088E+01	9.92262E-16	-7.58266E+01	6.25722E-12		
		131	-8.04903E-11	-2.05584E-11	-3.99088E+01	-9.92262E-16	7.58266E+01	-6.25722E-12		
40	12	1	-6.13070E+01	-1.33039E+02	8.26815E+01	-2.53370E+01	-5.61354E+02	-9.52726E+02		
		13	6.13070E+01	1.33039E+02	-8.26815E+01	2.53370E+01	5.61354E+02	9.52726E+02		
41	12	4	4.51722E+01	-1.32488E+02	1.40579E+01	1.53754E+01	-1.36084E+01	-9.14329E+02		
		14	-4.51722E+01	1.32488E+02	-1.40579E+01	-1.53754E+01	1.36084E+01	9.14329E+02		
42	12	8	1.81295E+01	-1.48473E+02	6.47758E+01	-1.57522E+02	-4.19044E+02	-7.69340E+03		
		16	-1.81295E+01	1.48473E+02	-6.47758E+01	1.57522E+02	4.19044E+02	7.69340E+03		
200	12	13	-1.81913E+01	-3.66543E+00	-1.97793E+01	-1.18878E+01	3.90582E+02	-8.71617E+01		
		200	1.81913E+01	3.66543E+00	1.97793E+01	1.18878E+01	-3.90582E+02	8.71617E+01		
201	12	14	1.11507E+01	-6.35208E+00	1.35315E-01	-1.48919E+02	-1.73831E+02	-1.51980E+02		
		200	-1.11507E+01	6.35208E+00	-1.35315E-01	1.48919E+02	1.73831E+02	1.51980E+02		
202	12	200	5.49697E+00	6.01126E+00	-6.09064E+00	3.52027E+02	8.10686E+01	1.16006E+02		
		16	-5.49697E+00	-6.01126E+00	6.09064E+00	-3.52027E+02	-8.10686E+01	-1.16006E+02		

STRESS RESULTANTS FOR LINE ELEMENTS - LOAD COMBINATION ID NO. 3 (CONTINUED)

MINIMUM/MAXIMUM LOCAL RESULTANTS

ELE NO.	MIN/MAX AXIAL	ELE NO.	MIN/MAX Y-SHEAR	ELE NO.	MIN/MAX Z-SHEAR	ELE NO.	MIN/MAX TORQUE	ELE NO.	MIN/MAX Y-MOMENT	ELE NO.	MIN/MAX Z-MOMENT
19	-1.59236E+02	28	-1.63512E+02	31	-1.59236E+02	202	-3.52027E+02	20	-2.15037E+03	27	-2.28917E+03
19	1.59236E+02	28	1.63512E+02	31	1.59236E+02	202	3.52027E+02	19	2.15037E+03	28	2.28917E+03
*** E M R C N I S A *** - MS DOS/VERSION 88.7 - (083088) 3/27/1990 21:53:50											

STEWART TECHNOLOGY ASSOCIATES - LIFTBOAT ANALYSIS
NISA Finite Element Analysis Results For 65 feet Water Depth
70 knot wind, 20 foot wave height, 10 seconds period, 2 knot current
Page 14

O V E R A L L T I M E L O G I N S E C O N D S

```

INPUT / READ GENERATE .....= 14.580
DATA SORTING AND CHECKING .....= 3.990
REORDERING OF ELEMENTS .....= 3.990
FORM ELEMENT MATRICES .....= 34.840
FORM GLOBAL LOAD VECTOR .....= 3.350
MATRIX TRANSFORMATION DUE TO MPC .....= 0.000
PRE-FRONT .....= 1.980
SOLUTION OF SYSTEM EQUATIONS .....= 17.430
INTERNAL FORCES AND REACTIONS .....= 26.020
STRESS CALCULATION .....= 28.790
LOAD COMBINATION .....= 17.680
TOTAL CPU .....= 158.650

```

```

NISA JOB FINISHED AT - 21:53:51    3/27/1990
TOTAL ELAPSED TIME IS .....= 237.000

```

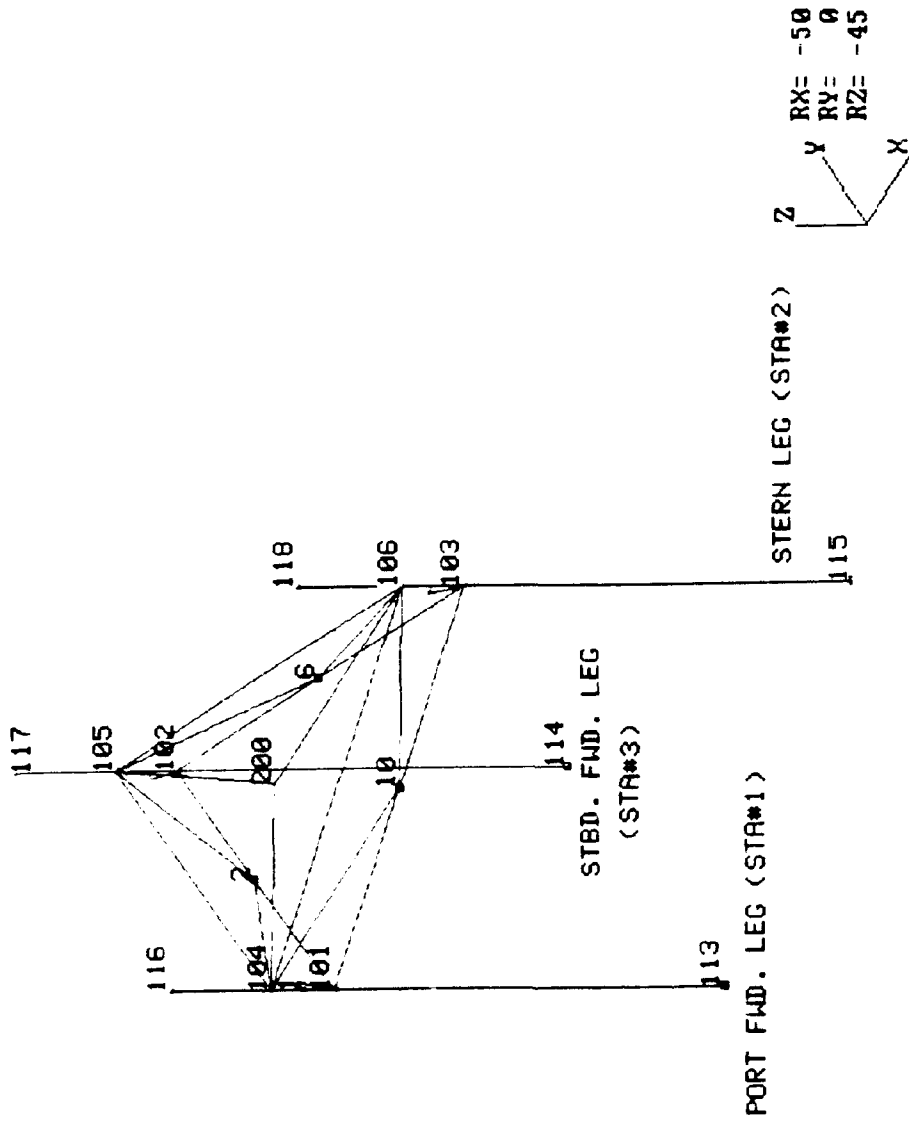

FULL MODEL SHOWING MAIN NODE NUMBERS

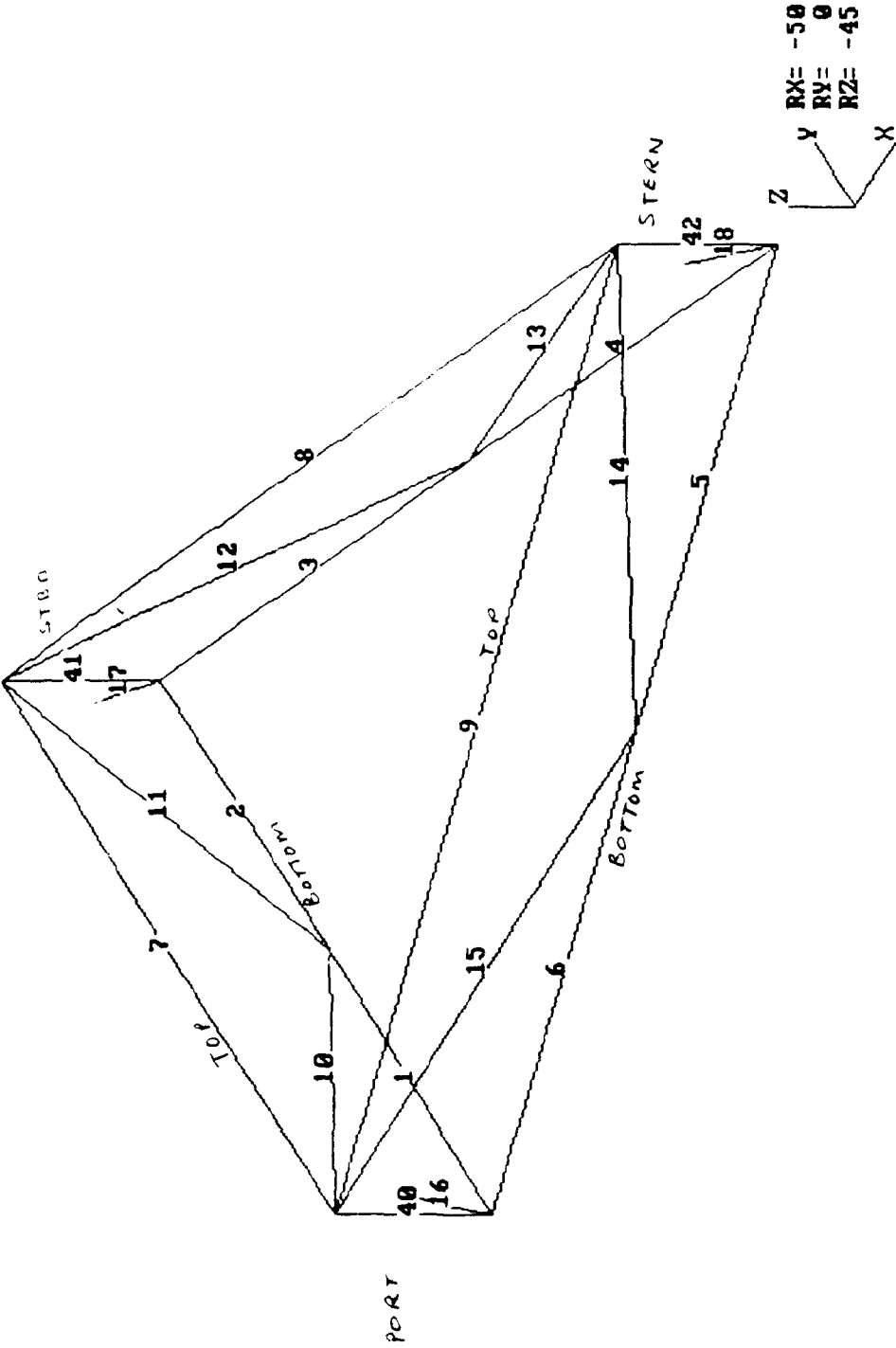

HULL ELEMENT NUMBERS

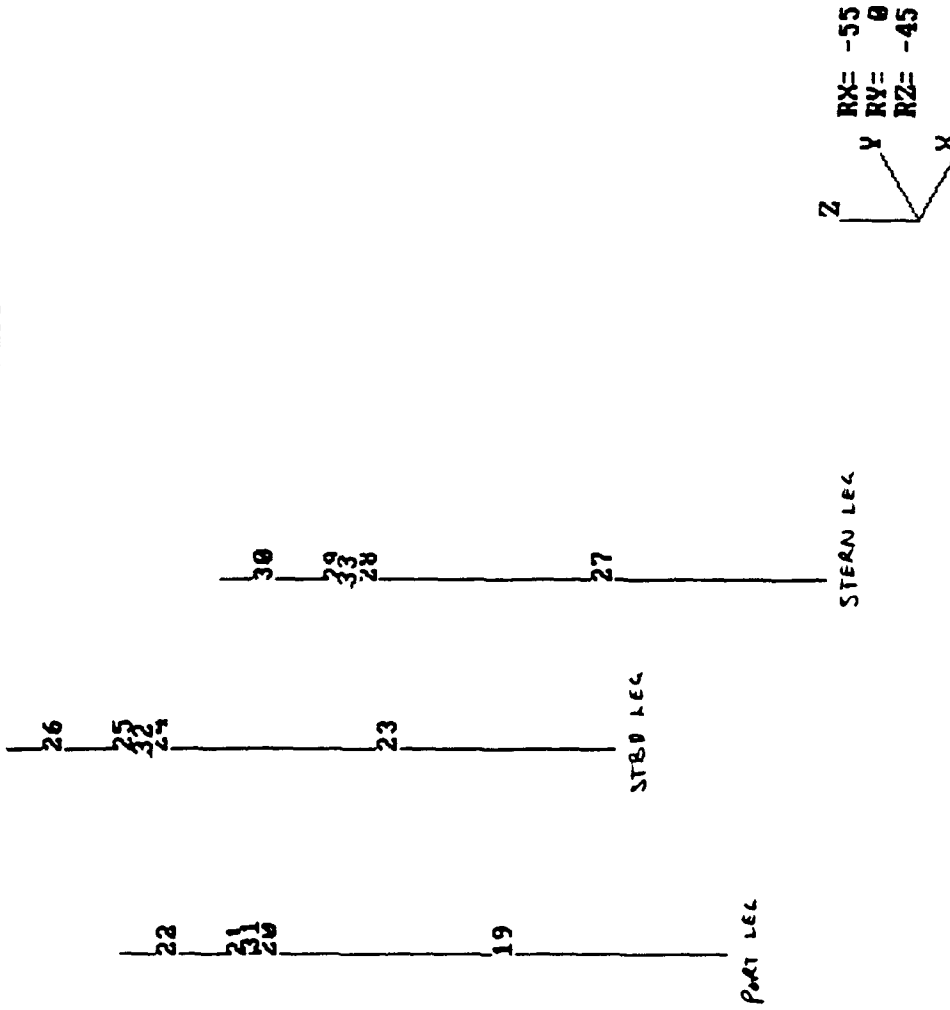

LEG ELEMENT NUMBERS

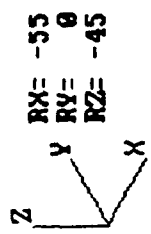
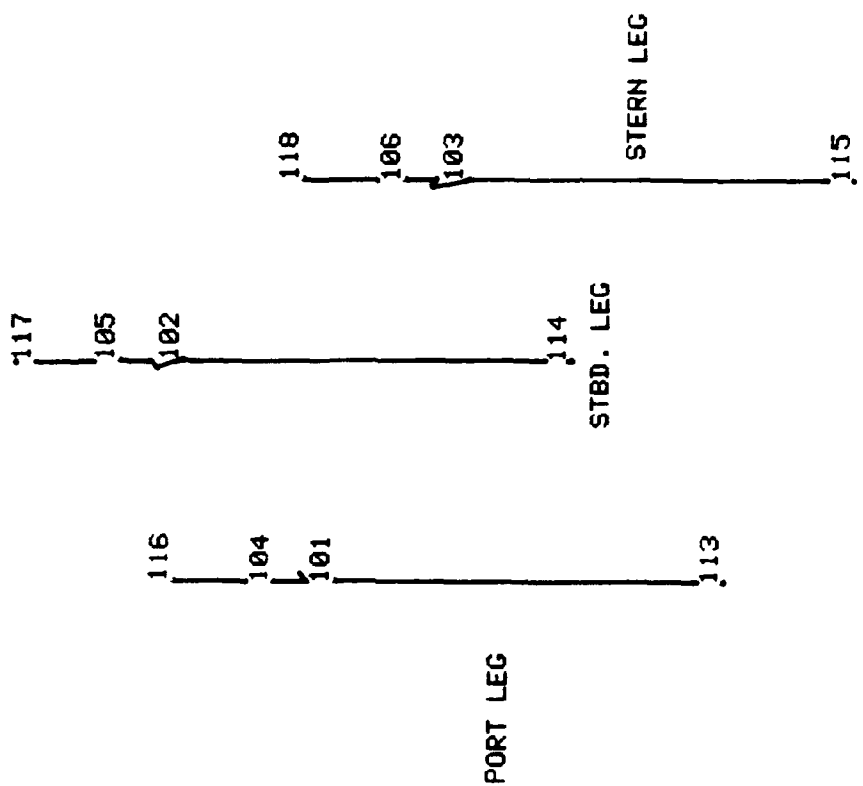

LEG MAIN NODE NUMBERS

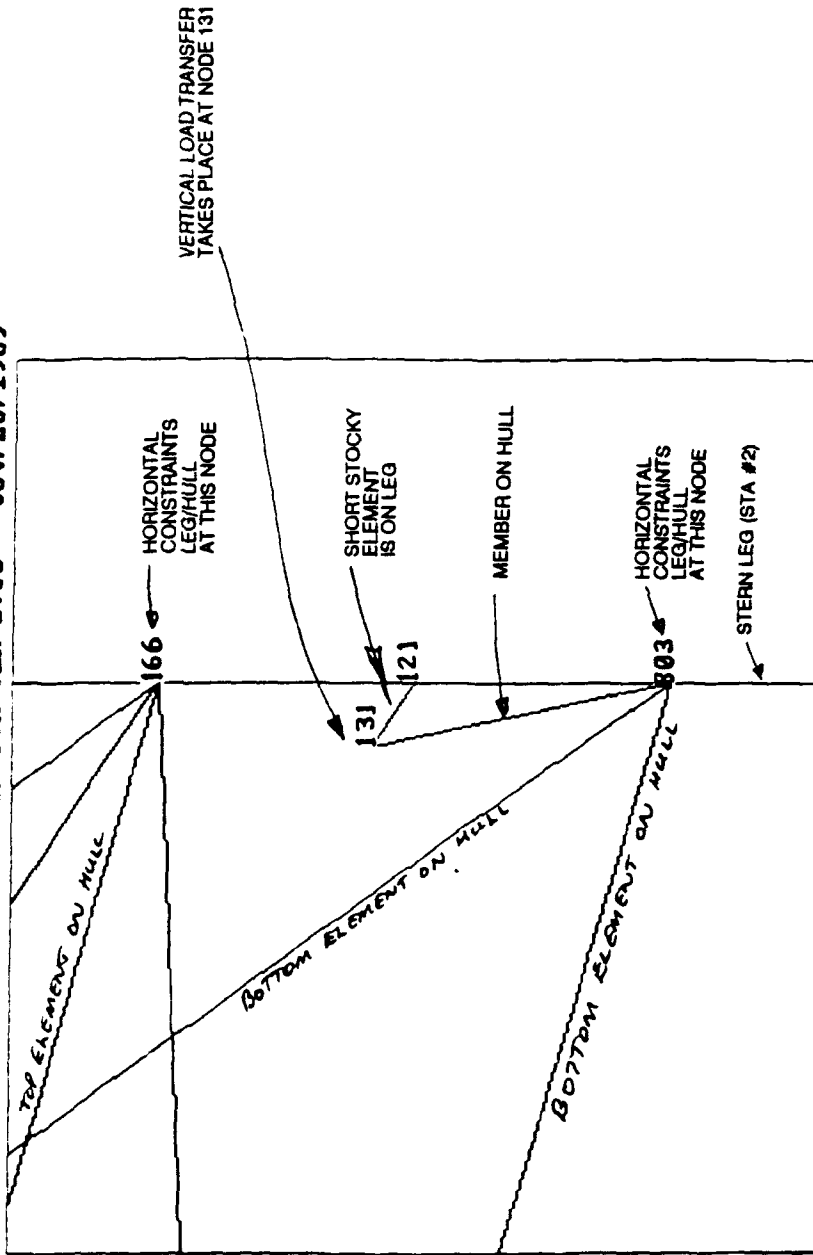

NODE NUMBERS IN REGION OF LEG 2 CONNECTION TO LIFTBOAT HULL

APPENDIX 6

Secondary Bending Analysis Techniques

This appendix provides a detailed explanation of the techniques recommended for the structural analysis of liftboats accounting for secondary bending effects. Two approaches are explained, both of which are implemented as a check upon one another in STA LIFTBOAT.

Calculation of effective length factors (K-factors) is also described and methods used are compared with methods used in the analysis of more conventional stiff framed buildings.

The effect on the lateral stiffness (and effective length factor) as a consequence of a rotational spring at the bottom of the legs is also explained in detail. The solution to the magnitude of the spring, using pad geometry and soil properties, is explained, and the limiting maximum value of the spring is explained using plastic failure analysis of the soil under the pad.

By W.P. Stewart, April 1990

1.0 INTRODUCTION

In order to calculate liftboat leg deflections and stresses, classical beam and column formulae are used. The basic equations may be found in Roark (Reference 1). The principal of superposition is used to determine deflections, rotations, reactions, and moments. Results are compared with alternative methods, and with STA LIFTBOAT results.

2.0 TOP FIXITY CONDITIONS

In accordance with the requirements of the original scope of work, the liftboat hull is treated as being rigid. However, the top leg fixity is modelled with the leg being restricted by an upper and lower horizontal guide reaction, with vertical reactions applied at the pinions, between the upper and lower guides. In the first place this is similar to a guided condition (i.e. no rotation permitted) but it will be shown later that additional flexibility results as a function of the guide spacing.

3.0 LATERAL LOADS, BOTTOM PINNED

This condition corresponds to Table 3, Case 1f, in Reference 1. The schematic diagram is shown in Figure 1, below.

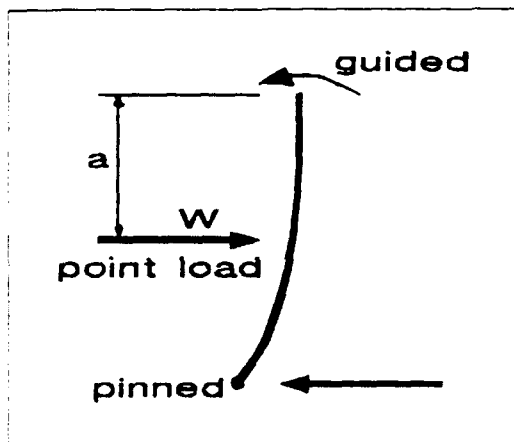

Figure 1

INPUT VARIABLES

W := 23.97 kip	wave load on leg
a := 36.63 ft	see Fig. 1
l := 88 ft	leg length
E := 29500 ksi	Young's modulus
I := .6769 ft ⁴	area mom.inertia
Wind := 12.52 kip	wind load on leg

3.1 Top Moment, MA1, Caused By Lateral Loads

$$MA1 := W \cdot (l - a) + Wind \cdot l$$

$$MA1 = 2.333 \cdot 10^3 \text{ ft} \cdot \text{kip}$$

3.2 Top Deflection, y_{A1} , Caused By Lateral Loads

$$y_{A1} := \frac{-(W \cdot (1 - a))}{6 \cdot E \cdot I} \left[2 \cdot l^2 + 2 \cdot a \cdot l - a^2 \right] - \frac{\text{Wind}}{3 \cdot E \cdot I} \cdot l^3$$

$$y_{A1} = -2.459 \cdot \text{ft}$$

3.3 Bottom Rotation, θ_{B1} , Caused by Lateral Loads

$$\theta_{B1} := \frac{W}{2 \cdot E \cdot I} \left[l^2 - a^2 \right] + \frac{\text{Wind}}{2 \cdot E \cdot I} \cdot l^2$$

$$\theta_{B1} = 2.495 \cdot \text{deg}$$

4.0 DEFLECTED SHAPE AS A CONSEQUENCE OF SOIL SPRING

The consequence of soil stiffness resisting rotation of the footing at the bottom of the liftboat leg may be idealized as Table 3, Case 3f, in Reference 1. The schematic diagram is shown in Figure 2, below.

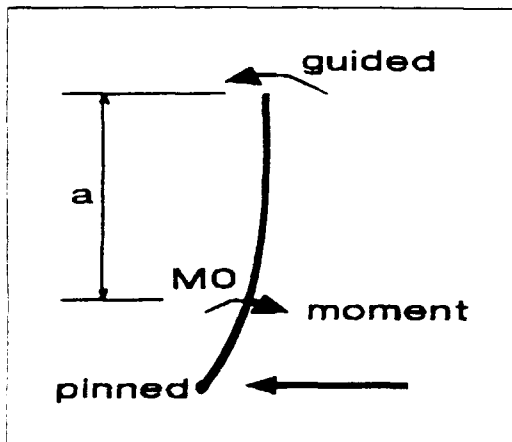

Figure2

INPUT TERMS

At this point M_0 is unknown, as it is a function of the magnitude of the rotation. As the moment occurs at the bottom of the leg, $a = l$.

Guess at M_0 :

$$M_0 := 200 \cdot \text{ft} \cdot \text{kip}$$

4.1 Top Moment, M_{Am} , Caused By Footing Moment

$$M_{Am} := -M_0$$

4.2 Top Deflection, y_{Am} , Caused By Footing Moment

$$y_{Am} := \frac{M_0 \cdot l}{2 \cdot E \cdot I} \cdot (2 \cdot l - l) \quad y_{Am} = 0.269 \cdot \text{ft}$$

4.3 Bottom Rotation, θ_{Bm} , Caused By Footing Moment

$$\theta_{Bm} := \frac{-(M_0 \cdot l)}{E \cdot I}$$

5.0 SUPERPOSITION OF EFFECTS OF LATERAL LOAD AND FOOTING MOMENT

The combined load-response diagram is shown schematically in Figure 3, below.

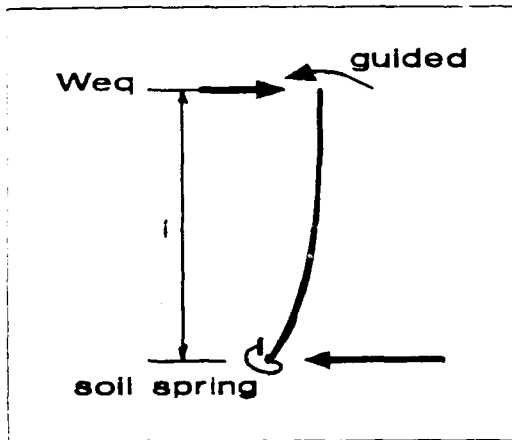

Figure 3

INPUT TERMS

The footing moment can be idealized as a rotational spring, with stiffness, k_s . A value for k_s is selected, with further explanation on calculating this stiffness given later.

$$k_s := 43904 \cdot \text{ft} \cdot \text{kip} \cdot \text{rad}^{-1}$$

M_0 is equal to $k_s \cdot \theta$

5.1 Find Equivalent Top Load, $Weq\theta$, Resulting In Same θ_B as $W + \text{Wind}$

$$Weq\theta := W \cdot \begin{bmatrix} 2 & 2 \\ 1 & -a \\ 2 & \\ 1 & \end{bmatrix} + \text{Wind}$$

$$Weq\theta = 32.337 \cdot \text{kip}$$

5.2 Find Bottom Angle, θ_{Bcomb} , Resulting From Combined System

$$\begin{aligned} \theta_{Bc} &:= \theta_{B1} + \theta_{Bm} \\ \theta_{Bc} &= 2.144 \cdot \text{deg} \end{aligned}$$

$$\begin{aligned} \theta_{B1} &= 2.495 \cdot \text{deg} \\ \theta_{Bm} &= -0.351 \cdot \text{deg} \end{aligned}$$

Note that this value of θ_{Bc} is calculated as if we already knew the moment caused by the rotation of the footing, or soil spring. In fact we do not, but we do know that the moment is equal to $k_s \cdot \theta_{Bc}$. The terms may be re-arranged to give an equation in terms of θ_{Bc} :

$$\theta_{Bc} \approx \theta_{B1} - \frac{k_s \cdot \theta_{Bc} \cdot l}{E \cdot I}$$

This is a MathCad solve block.

$$\text{Find}(\theta_{Bc}) = 1.065 \cdot \text{deg}$$

Further re-arrangement of terms gives a direct solution for θ_{Bc} :

$$\theta_{Bc} := \text{Weq}\theta \cdot \frac{l^2}{2 \cdot (E \cdot I + k_s \cdot l)}$$

$$\theta_{Bc} = 1.065 \cdot \text{deg}$$

5.3 Find Bottom Combined Moment, M_{Bc}

$$M_{Bc} := k_s \cdot \theta_{Bc}$$

$$M_{Bc} = 815.719 \cdot \text{ft} \cdot \text{kip}$$

5.4 Find Equivalent Top Load, W_{eqy} , Resulting In Same y_A as $W + \text{Wind}$

$$W_{eqy} := W \cdot \frac{(1 - a) \cdot [2 \cdot l^2 + 2 \cdot a \cdot l - a^2]}{2 \cdot l^3} + \text{Wind}$$

$$W_{eqy} = 31.125 \cdot \text{kip}$$

5.5 Find Top Combined Moment, M_{Ac}

The top moment found for the case of a pin-joint at the bottom, is reduced by the bottom moment resulting from the soil spring.

$$M_{Ac} := M_{A1} - M_{Bc}$$

$$M_{A1} = 2333.099 \cdot \text{ft} \cdot \text{kip}$$

$$M_{Ac} = 1517.38 \cdot \text{ft} \cdot \text{kip}$$

5.6 Find Top Combined Deflection, y_{Ac}

The top deflection found for the case of a pin-joint at the bottom, is reduced by the bottom moment resulting from the soil spring.

$$y_{AC} := y_{A1} + k_s \cdot \theta_{BC} \cdot \frac{l^2}{2 \cdot E \cdot I} \quad y_{A1} = -2.459 \cdot \text{ft}$$

$$y_{AC} = -1.36 \cdot \text{ft}$$

5.7 Find Combined Effective Length Factor, K_c

Lateral stiffness for pin-jointed case, k_p , is found from:

$$k_p := \frac{3 \cdot E \cdot I}{l^3} \quad \text{In this case the effective length factor, } K_p, \text{ is } 2.00.$$

At this point it is convenient to introduce a term, c , or, c_p , for the pinned case, in accordance with DnV Class Note 31.5, page 44, Section 5.6.8 (Reference 2):

$$c_p := \frac{3 \cdot E \cdot I}{k_p \cdot l^3} \quad c_p = 1$$

Lateral stiffness for the combined case, k_c , can be found from dividing the equivalent combined lateral load by the combined lateral deflection:

$$k_c := \frac{-W_{eqy}}{y_{AC}}$$

The term, cc , now accounts for the equivalent flexibility of the combined case:

$$cc := \frac{3 \cdot E \cdot I}{k_c \cdot l^3} \quad cc = 0.553$$

The effective length factor for the combined case, K_c , is now found as a function of c , (page 46, Reference 2):

$$K_c := 2 \cdot \sqrt{cc} \quad K_c = 1.488$$

6.0 ALTERNATIVE APPROACH USING RELATIVE STIFFNESSES

An alternative approach to calculating effective leg length factors is suggested in Reference 3. Using equation 2 from this reference, the K-factor is developed below:

$$GA := 0 \quad \text{top fixity coefficient (fully fixed)}$$

$$GB := \frac{6 \cdot E \cdot I}{1 \cdot ks}$$

bottom fixity coefficient (page 5, Reference 3)

$$GB = 4.466$$

Given

$$\frac{(GA \cdot GB) \cdot \left[\frac{\pi}{Kc} \right]^2 - 36}{6 \cdot (GA + GB)} \approx \frac{\pi}{Kc} \cdot \frac{1}{\tan \left[\frac{\pi}{Kc} \right]}$$

MathCad solve block used to solve Equation (2) from Reference 3, to find effective length factor, Kc.

$$Kc3 := \text{Find}(Kc)$$

$$Kc3 = 1.473 \quad (\text{from above equation})$$

$$Kc = 1.488 \quad (\text{from STA method, above})$$

$$\text{Difference} := \frac{Kc3 - Kc}{Kc}$$

$$\text{Difference} = -0.992\%$$

From the small difference between the answers, it can be concluded that the two methods give very similar results. However, the upper guide spacing has yet to be accounted for as has the increased flexibility because of axial load.

7.0 ACCOUNTING FOR FOUNDATION STIFFNESS ACCORDING TO Reference 2

Reference 2 introduces a factor, mu, which determines the leg bending moment at the bottom. Ignoring the shear flexibility, the portion of the moment taken by a vertical couple, and the guide spacing, mu is found from:

$$\mu := \frac{1}{1 + \frac{2 \cdot E \cdot I}{ks \cdot l}} \quad \mu = 0.402$$

From mu, the bending flexibility is developed:

$$fb := \frac{1}{3 \cdot E \cdot I} \cdot \left[1 - \frac{3 \mu}{2(1 + \mu)} \right] \quad k2 := \frac{1}{fb}$$

$$k2 = 22.207 \cdot kpf$$

Lateral stiffness is reciprocal of the flexibility.

$$kc = 22.879 \cdot kpf$$

Result from STA classical method.

$$\text{Diff} := \frac{k_2 - k_c}{k_2}$$

$$\text{Diff} = -3.027\%$$

The small difference between the answers indicates that the methods yield very similar results.

8.0 ACCOUNTING FOR THE SEPARATION OF THE HORIZONTAL GUIDES

It can be shown, for a pin-jointed bottom, that the lateral deflection in response to a horizontal load applied at the deck level is affected by the guide spacing in accordance with the following:

$$y_g := y_{Ac} \cdot \left[1 + \frac{d}{l} \right]$$

$d := 14 \text{ ft}$ vertical separation of the guides

Where y_g is the lateral deflection of the leg with spacing d between the guides.

(note this formula becomes progressively less accurate as k_s increases)

8.1 Define a New Lateral Stiffness With Guides, k_g

$$k_g := \frac{-W e q_y}{y_g}$$

8.2 Calculate Effective Flexibility, c_g , With The Guide Spacing

$$c_g := \frac{3 \cdot E \cdot I}{k_g \cdot l^3}$$

8.3 Calculate Effective Length Factor, K_g , With The Guides

$$K_g := 2 \cdot \sqrt{c_g}$$

$$K_g = 1.602 \quad \text{effective length considering guide spacing}$$

This is the value for the K-factor, as output by the STA programs, and as plotted in the STA "Variation of K-Factors" Report, dated April 3, 1990 (Reference 5).

Note that the effective length with guide spacing considered is reduced compared to the "perfectly" guided case, K_c , shown on page 6. The DnV formulae take account of the bottom stiffness more accurately than in Section 8.0, above, which slightly over-estimates the sway response when the bottom is not pinned.

$$\frac{K_c - K_g}{K_c} = -7.661\%$$

$$fbg2 := \frac{1^3}{3 \cdot E \cdot I} \left[1 - \frac{3 \mu}{2(1 + \mu)} + \frac{1}{1 + \mu} \frac{d}{l} \right] \quad \text{flexibility from Ref. 2}$$

$$kg2 := \frac{1}{fbg2}$$

kg2 = 18.52 kpf Effective stiffness from Reference 2 (DnV)

kg = 19.739 kpf Effective stiffness from STA classical methods

$$\text{Diffg} := \frac{kg2 - kg}{kg2}$$

Note that this is the difference between the lateral stiffness found by the two methods. They show a closer agreement on the reduced K-factors.

Diffg = -6.582 % The small difference between the answers indicates that the methods yield similar results. The STA program, using DnV formulae, is more accurate.

9.0 CALCULATION OF ROTATIONAL STIFFNESS OF FOOTING

In Reference 2, the footing stiffness is idealized as a disk on an elastic half-space. This results in the following formula:

Define Footing & Soil Terms:

su := 160 psf	soil shear strength beneath footing
Gfactor := 150	factor on su to get shear modulus of soil
r := 7 ft	effective radius of footing
width := 10 ft	width of footing
length := 25 ft	length of footing
v := 0.5	Poisson's ratio for cohesive soil

9.1 Calculate Soil Shear Modulus

Gsoil := Gfactor · su Gsoil = 166.667 psi

9.2 Disk on Elastic Half-Space Formula (Reference 2)

$$ks2 := \frac{8 \cdot G_{soil} \cdot r^3}{3 \cdot (1 - \nu)}$$

ks2 = 43904 ft · $\frac{\text{kip}}{\text{rad}}$ value of rotational soil spring from Ref. 2

9.3 Area Moment and Gsoil Formula (Reference 3)

$$\text{AreaMom} := \frac{\pi \cdot r^4}{4}$$

$$\text{ks3} := \text{AreaMom} \cdot \text{Gsoil} \cdot \text{ft}^{-1}$$

$$\text{ks3} = 45258 \cdot \text{ft} \cdot \frac{\text{kip}}{\text{rad}}$$

Note that in Reference 3, the writer uses the area moment for a rectangular footing. For the purpose of comparison with the method of Reference 2, the area moment for a circular footing is developed here.

value of rotational soil spring from Ref. 3

9.4 Ratio Between The Two Approaches

$$\text{Ratio} := \frac{\pi \cdot 3 \cdot (1 - \nu)}{32} \cdot r$$

$$\text{Ratio} = 0.147 \cdot r \cdot \frac{\text{ks3}}{\text{ks2}} = 1.03$$

$$0.147 \cdot r = 1.03 \cdot \text{ft}$$

This result shows that the two approaches are a function of the Poisson's ratio of the soil and the effective diameter of the footing. However, note that both approaches use the shear modulus, Gsoil, of the soil. An ultimate moment capacity is developed by plastic analysis in the next part of this document.

10.0 REDUCTION IN LATERAL STIFFNESS CAUSED BY AXIAL LOAD

The axial load on the legs causes a greater flexibility, or lower lateral stiffness. This is accounted for in the STA programs by a correction factor based on the Euler buckling load of the leg, PE. The Euler buckling load is given below. Using this correction factor, the lateral deflection is found to be within 2% of the final deflection if the classical method is used, the additional deflection as a result of the P-Delta effect is found, and the solution is iterated to equilibrium.

10.1 Euler Buckling Load

$$\text{PE} := \frac{\pi^2 \cdot E \cdot I}{K_g^2}$$

(Kg · l)

$$\text{PE} = 1429 \cdot \text{kip}$$

(page 46 Reference 2)
Note that the Euler load should be calculated for the weakest axis of the leg, if the leg is stiffer in one direction than the other.

Note that Kg is the K-factor, accounting for the top and bottom fixity conditions of the leg.

10.2 Calculate Effective Stiffness

INPUT TERMS

$$\text{ReductionFactor} := \left[1 - \frac{P}{PE} \right]$$

P := 191 kip average axial leg load selected for this run.

ReductionFactor = 0.866

ke := ReductionFactor · kg2

ke = 16.044 · kpf effective lateral stiffness accounting for axial loading on the leg

yfinal := $\frac{Weqy}{ke}$ yfinal = 1.94 ft final sway deflection

10.3 Compare Results

Kc = 1.488	K-factor w/top guided & soil spring
Kg = 1.602	K-factor w/correct top & soil spring
kc = 22.879 · kpf	lateral stiffness w/top guided & soil spring
kg = 19.739 · kpf	lateral stiffness w/correct top & soil spring
ke = 16.044 · kpf	lateral stiffness w/correct top, soil, and axial load
θBc = 1.065 · deg	rotation of footing
Weqy = 31.125 · kip	equivalent total load applied at top (to give yfinal)
yfinal = 1.94 · ft	lateral deflection of hull, or top of leg
ks = 43904 · ft · kip	value of soil stiffness rotational spring
MAc = 1517 · ft · kip	bending moment at top of leg (w/o P-Delta increase)
MBC = 816 · ft · kip	bending moment at bottom of leg (w/o P-Delta inc.)
mu = 0.402	DnV moment coefficient for bottom of leg
PE = 1429 · kip	Euler buckling load for leg
su = 160 · psf	undrained shear strength of soil used to find ks
Gfactor = 150	factor on su used to find Gsoil
P = 191 · kip	average axial leg load used to find ke

COMPARISON OF MATHCAD RESULTS WITH STA LIFTBOAT PROGRAM

VARIABLE	MATHCAD	STA STATIC	STA DYNAMIC
Equivalent top load	31.13 kips	31.13 kips	32.63 kips
Lateral deflection	1.94 ft	1.86 ft	1.95 ft
Lateral stiffness	16.04 kpf	16.67 kpf	16.67 kpf
K-factor	1.602	1.618	1.618
Euler leg load	1429 kips	1400 kips	1400 kips
Bottom leg angle	1.07 deg.	1.06 deg.	1.12 deg
BM hull w/o PDelta	1517 ft-kip	1518 ft-kip	1577 ft-kip
BM hull w/PDelta	2160 ft-kip	2161 ft-kip	2265 ft-kip
BM footing w/o PD	816 ft-kip	816 ft-kip	856 ft-kip
ksoil	43904 ft-kip	43904 ft-kip	43904 ft-kip
mu	0.402	0.45	0.45

INPUT VARIABLES USED IN LIFT1

Kc := 1.488	Mbc := 820·ft·kip
Kg := 1.602	mu := .402
kc := 22.878	PE := 1429·kip
kg := 19.738	su := 191·psf
ke := 16.575	Gfactor := 150
θBc := 1.071·deg	P := 150·kip
Weqy := 31.309·kip	r := 7·ft
yfinal := 1.889·ft	width := 10·ft
ks := 43904·ft·kip	length := 25·ft
MAC := 1528·ft·kip	W := 24·kip
	Wind := 12.7·kip

11.0 CALCULATION OF FOOTING ULTIMATE MOMENT CAPACITY

Calculation of the value of rotational soil springs has been illustrated in the previous section, by two different methods. Both methods rely upon the soil shear modulus, G_{soil}. This term is notoriously difficult to predict, and is often given as a function of the magnitude of the soil strain (see Figure 5.3-3, Reference 4, where coefficient of subgrade reaction, or shear modulus, is plotted against deflection for laterally loaded piles in cohesive soils).

In soft cohesive soils the shear modulus may vary from 10 times the soil shear strength (Gfactor = 10) to 1000 times the soil shear strength, depending upon the strain, or deflection, of the soil. At very small strains, very large shear moduli exist. At very large strains, very low shear moduli exist.

Using plastic analysis, a limiting, or ultimate, moment capacity for the footing of a liftboat can be calculated. This is done below for the equivalent circular footing and for rectangular footings.

11.1 Ultimate Moment Capacity For Circular Footing

The failure surface is hemispherical. The undrained shear strength is mobilized throughout the failure surface. The moment capacity will be reduced if applied vertical loads are close to maximum pre-load levels. The moment capacity will also be reduced by horizontal loads. The appropriate undrained shear strength is the shear strength at a distance of one half-radius beneath the footing, unless the shear strength changes significantly within a depth of one radius beneath the footing.

suAv := 1.2·su

This defines the average soil shear strength beneath the footing. The user must define the factor on su.

$$\text{MultCirc} := \frac{1}{2} \pi \cdot r^3 \cdot \text{suAv}$$

r = 7·ft selected footing radius

MultCirc = 387.952·ft·kip

Ultimate moment capacity of selected footing on selected soil.

While MultCirc is greater than M_{Bc} , the ultimate moment capacity of the footing is not exceeded (unless the vertical applied load is close to the load achieved during preload). A higher soil modulus may be considered in such cases, while the soil modulus must be reduced if the bending moment developed exceeds the moment capacity. Note that the applied load in this case was:

$W = 24 \cdot \text{kip}$ wave force acting along leg
 $\text{Wind} = 12.7 \cdot \text{kip}$ wind force acting at top of leg

12.0 DISCUSSION OF RESULTS

The shear flexibility of the leg is included in the STA programs, but not in the MathCad file. The bending flexibility of the deck is not included in either approach, in accordance with the scope of work, although it could be. The lack of perfect fit, and the component of the moment carried in a vertical couple, is considered in the STA programs, but not in this MathCad file.

The STA program results (for statics) as tabulated in Section 10, show some slight differences from the MathCad classical theory results as a consequence of using the DnV formulation for lateral stiffness. A slightly larger K-factor (less than 1% different) results from the DnV stiffness formulation. This results in a slightly lower Euler buckling load for the leg (2% different).

Note that dynamic effects have not been included and that the relationship between the soil modulus and the soil shear strength is purely empirical. However, given that a soil modulus can be determined, the three methods investigated here give similar results. Unfortunately the author of Reference 3 does not pursue the increased flexibility inevitably caused by the guide spacing, or by the axial load effects.

Note that the axial stiffness reduction term $(1-P/PE)$ results in virtually the same lateral excursions as the iteration of the P-Delta term called for in the original scope of work.

In all cases, when performing liftboat elevated response analysis, it is desirable to include all components, static and dynamic, which contribute to lateral, or sway, response. Where soil stiffness effects are included, the resulting bending moments induced at the footing must be compared with the ultimate moment capacity of the footing. If the ultimate capacity of the footing is exceeded, the analysis must be run again with a reduced soil modulus.

12.0 CONCLUSIONS

- 12.1 Reduction in the effective length coefficients, or K-factors, for liftboat legs, may be calculated as a result of soil restraint at the footings, by classical means and by other methods (as illustrated in References 2 and 3).
- 12.2 K-factors greater than 2.00 and increased lateral flexibility result for the theoretical case of a pin-joint at the footing as a consequence of several phenomena. The most important are:
- a) The leg is not fully restrained by the deck.
 - b) Axial loads reduce effective lateral leg stiffness.
- 12.3 Ultimate, or maximum possible, moment capacity at the footing can be calculated more reliably than the equivalent soil spring value (and consequent reduction in K-factor) in cohesive soils, as the soil modulus is a highly variable function of the strain in the soil (or footing rotation in response to applied loads).
- 12.4 STA liftboat programs incorporate the same, or equivalent, analysis methods as described by other published work in this field.

13.0 REFERENCES

1. Roark, R.J., and Young, W.C., "Formulas For Stress and Strain", Fifth Edition, McGraw-Hill Book Co. 1975.
2. Det norske Veritas, "Strength Analysis of Main Structures of Self Elevating Units", Classification Note 31.5, May, 1984.
3. Korkut, M.D. "Calculation of "K" Factors In The Leg Design of Lift Boats With Comparison of Methods", SNAME Gulf Section Paper, July, 1979.
4. Rocker, K., "Handbook for Marine Geotechnical Engineering", Naval Civil Engineering Laboratory, Port Hueneme, CA, March, 1985.
5. Stewart, W.P. "Liftboat Leg Strength Structural Analysis", Interim Report from USCG Contract No. DTCG39-89-C-80825, February, 1990.

W.P. Stewart, P.E.
April 9, 1990

APPENDIX 7

Calculation of Torsional Response

The torsional response of liftboats is more important than the torsional response of jack-up rigs, principally because the general layout of a liftboat with the superstructure towards the aft end, causes a center of pressure for wind loads on the beam which is quite a distance from the geometric leg center. Additionally, the hydrodynamic loads on the legs, as a consequence of the rack orientations, may contribute further to this torsional effect. With jack-up rigs the loading on the legs tends to compensate for the wind loading on the hull.

This appendix presents a method which can be used to calculate torsional response of a liftboat. The method accounts for the correct area moments of inertia of the liftboat legs and permits the loading to be applied at any angle in the horizontal plane. Results have been compared with finite element solutions and they agree to within less than 1% for the reactions and to within less than 2% for the hull deflections.

INTRODUCTION

In order to calculate lateral leg reactions as a consequence of wind loads on the hull of a liftboat, the vessel torsional stiffness is considered. The legs are idealized as linear springs, as shown in the figure below, with appropriate stiffnesses in the x- and y-directions. Eccentric loads may be applied in both directions. The stiffness center is found as the first step in the solution. In the next step, the rotation of the hull is found using the moment arm from the stiffness center to the applied load. Then forward leg x-direction reactions in response to the rotation are found. In the case of applied eccentric loads in the x-direction, these reactions make up only part of the total footing reactions. The other part comes from the x-direction load which is shared by each leg in proportion to its x-direction stiffness.

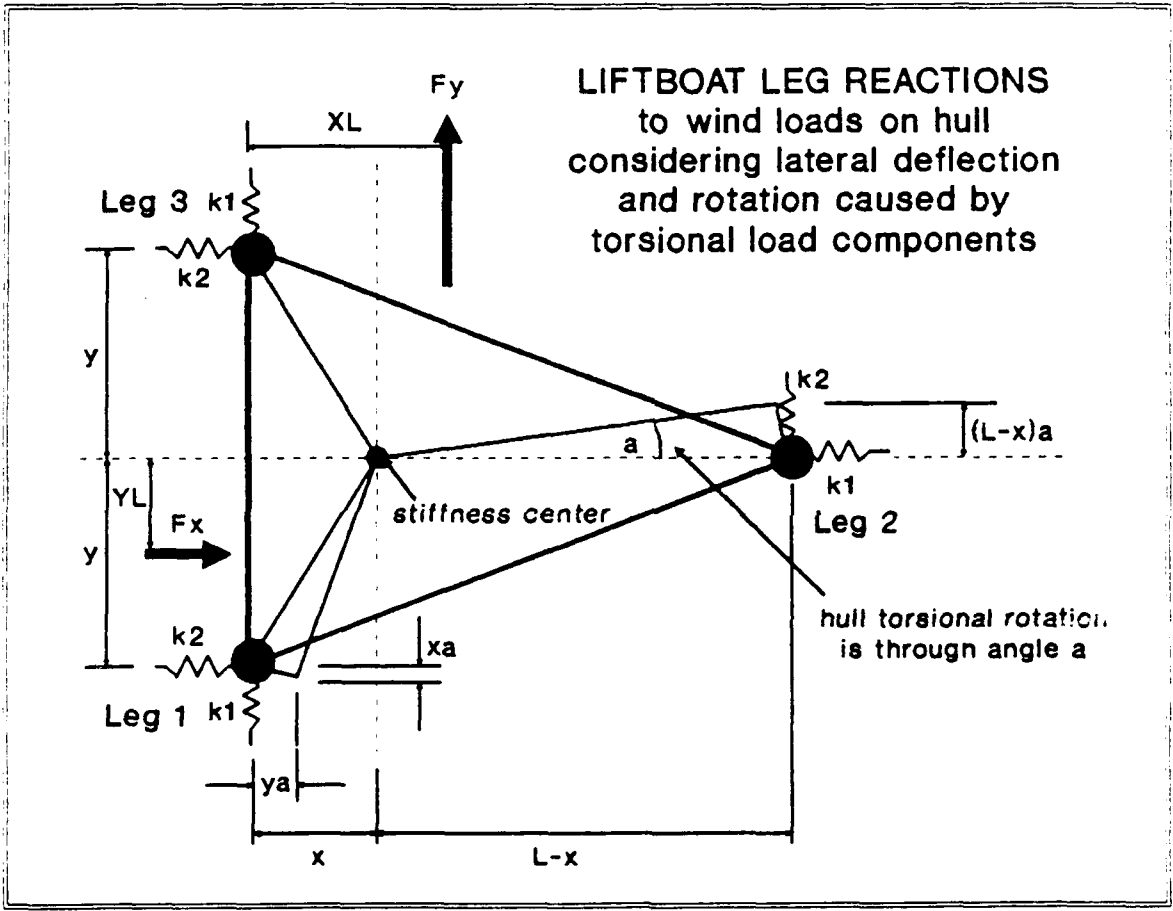

INPUT TERMS

- | | |
|--------------------|---|
| L := 66 ft | distance from fwd to aft leg centers |
| y := 25 ft | distance from centerline to aft leg center |
| k := 10 kpf · .945 | nominal stiffness value of one leg in kpf |
| k1 := 1.48813 · k | k1 as shown in diagram above |
| k2 := 1.13487 · k | k2 as shown in diagram above |
| Fy := 440 kip | applied wind load component on beam |
| XL := 66 ft | distance from fwd leg centers to beam wind center |
| Fx := 0 kip | applied wind component on stern |
| YL := 0 ft | distance from c/l to stern wind center |

FIND LONGITUDINAL CENTER OF STIFFNESS, x

Guess at x: $x := .33 \cdot L$

Given

$$2 \cdot k_1 \cdot x \approx (L - x) \cdot k_2$$

$x := \text{Find}(x)$

$x = 18.219 \cdot \text{ft}$ $X := XL - x$ distance from stiffness center
to lateral wind load center

FIND LEG REACTIONS IN RESPONSE TO F_y

Reactions due to moment about stiffness center

Guess at rotation, a: $a := 5 \cdot \text{deg}$

Given

$$F_y \cdot X \approx (L - x) \cdot a \cdot (L - x) \cdot k_2 + 2 \cdot x \cdot x \cdot a \cdot k_1 + 2 \cdot y \cdot y \cdot a \cdot k_2$$

$a := \text{Find}(a)$

$a = 25.506 \cdot \text{deg}$ hull rotation due to lateral wind component

Find x-forces in legs 1, 3, as a consequence of rotation:

$F_{Yx1} := -y \cdot a \cdot k_2$ $F_{Yx3} := y \cdot a \cdot k_2$
 $F_{Yx1} = -119.356 \cdot \text{kip}$ $F_{Yx2} := 0 \cdot \text{kip}$ $F_{Yx3} = 119.356 \cdot \text{kip}$

Find leg 2 reaction from moments about legs 1 and 3

$$F_{Yy2} := \frac{-XL \cdot F_y + (F_{Yx3} - F_{Yx1}) \cdot y}{L}$$

$F_{Yy2} = -349.579 \cdot \text{kip}$

Find leg 1, 3, y-reaction forces

$F_{Yy1} := 0.5 \cdot (-F_{Yy2} - F_y)$
 $F_{Yy3} := F_{Yy1}$
 $F_{Yy1} = -45.211 \cdot \text{kip}$

Reactions due to moment about stiffness center

Guess at b b := 5 deg

Given

$$-F_x \cdot Y_L \approx (L - x) \cdot b \cdot (L - x) \cdot k_2 + 2 \cdot x \cdot x \cdot b \cdot k_1 + 2 \cdot y \cdot y \cdot b \cdot k_2$$

b := Find(b)

b = 0 deg hull rotation due to longitudinal wind component

Find x-forces in legs 1, 3, as a consequence of rotation:

$$F_{xx1} := -y \cdot b \cdot k_2 \qquad F_{xx3} := -F_{xx1}$$

$$F_{xx1} = 0 \text{ kip}$$

Find leg 2 reaction from moments about legs 1 and 3

$$F_{xy2} := \frac{F_x \cdot Y_L + (F_{xx3} - F_{xx1}) \cdot y}{L}$$

$$F_{xy2} = 0 \text{ kip}$$

Find leg 1, 3, y-reaction forces

$$F_{xy1} := -0.5 \cdot F_{xy2}$$

$$F_{xy3} := F_{xy1}$$

Find x-reactions proportional to leg stiffnesses

$$F_{xxx1} := -F_x \cdot \frac{k_2}{2 \cdot k_2 + k_1}$$

$$F_{xxx3} := F_{xxx1}$$

$$F_{xxx2} := -F_x \cdot \frac{k_1}{2 \cdot k_2 + k_1}$$

$F_{Xx1} := F_{xx1} + F_{xxx1}$	$F_{Xx2} := F_{xxx2}$	$F_{Xx3} := F_{xx3} + F_{xxx3}$
$F_{Xx1} = 0 \cdot \text{kip}$	$F_{Xy1} = 0 \cdot \text{kip}$	$F_{X1} := F_{Xx1} + F_{Yx1}$
$F_{Xx2} = 0 \cdot \text{kip}$	$F_{Xy2} = 0 \cdot \text{kip}$	$F_{X2} := F_{Xx2} + F_{Yx2}$
$F_{Xx3} = 0 \cdot \text{kip}$	$F_{Xy3} = 0 \cdot \text{kip}$	$F_{X3} := F_{Xx3} + F_{Yx3}$
$F_{Yx1} = -119.356 \cdot \text{kip}$	$F_{Yy1} = -45.211 \cdot \text{kip}$	$F_{Y1} := F_{Xy1} + F_{Yy1}$
$F_{Yx2} = 0 \cdot \text{kip}$	$F_{Yy2} = -349.579 \cdot \text{kip}$	$F_{Y2} := F_{Xy2} + F_{Yy2}$
$F_{Yx3} = 119.356 \cdot \text{kip}$	$F_{Yy3} = -45.211 \cdot \text{kip}$	$F_{Y3} := F_{Xy3} + F_{Yy3}$

$F1 := \sqrt{F_{X1} \cdot F_{X1} + F_{Y1} \cdot F_{Y1}}$	$F3 := \sqrt{F_{X3} \cdot F_{X3} + F_{Y3} \cdot F_{Y3}}$
$F2 := \sqrt{F_{X2} \cdot F_{X2} + F_{Y2} \cdot F_{Y2}}$	

CALCULATE 1st-ORDER DEFLECTIONS OF TOPS OF LEGS

$x1 := \frac{-F_{X1}}{k2}$	$y1 := \frac{-F_{Y1}}{k1}$
$x2 := \frac{-F_{X2}}{k1}$	$y2 := \frac{-F_{Y2}}{k2}$
$x3 := \frac{-F_{X3}}{k2}$	$y3 := \frac{-F_{Y3}}{k1}$

SUMMARY OF RESULTS

a = 25.506 deg b = 0 deg hull rotation
a + b = 0.4452 rad hull rotation

$F_{X1} = -119.356 \cdot \text{kip}$	$F_{Y1} = -45.211 \cdot \text{kip}$	Forces at base of leg 1
$F_{X2} = 0 \cdot \text{kip}$	$F_{Y2} = -349.579 \cdot \text{kip}$	Forces at base of leg 2
$F_{X3} = 119.356 \cdot \text{kip}$	$F_{Y3} = -45.211 \cdot \text{kip}$	Forces at base of leg 3

$x1 = 11.12928 \cdot \text{ft}$	$y1 = 3.21491 \cdot \text{ft}$	Deflections at top leg 1
$x2 = 0 \cdot \text{ft}$	$y2 = 32.5962 \cdot \text{ft}$	Deflections at top leg 2
$x3 = -11.12928 \cdot \text{ft}$	$y3 = 3.21491 \cdot \text{ft}$	Deflections at top leg 3
$F1 = 127.632 \cdot \text{kip}$	$F2 = 349.579 \cdot \text{kip}$	$F3 = 127.632 \cdot \text{kip}$

The above results represent a single load case. They have been compared with a finite element model of the liftboat and reactions are within 0.3% of the FE model results. It should be noted that the solution technique for reactions is independent of the actual stiffness values, but is dependent only on the relative stiffness values. The above displacement values are dependent on the stiffness values. They compare to within 1.3% of the values predicted by the FE model, after making a 5.5% adjustment in the equivalent linear spring values (the FE model predicts more flexible legs than the STA JACKWAVE program).

Many additional load cases have been run, in addition to the single case reported here. In all cases the above relative comparisons hold true (reactions to within 0.3% and deflections to within 1.3%).

APPENDIX 8

Distributed Versus Point Load Applications

Wind loads act on the liftboat frame, essentially as point loads and torsional moments, acting on the hull, with additional individual point loads acting on each leg. However, the hydrodynamic wave-current loads are distributed over the submerged part of the legs, with rather non-uniform vertical profiles. In order to simplify computation of responses to these distributed loads, they may be approximated by point loads causing the same bending moment at the top of the leg and having the same horizontal magnitude as the distributed loads.

The information presented in this appendix demonstrates that this simplification is reasonable. The moments induced at the lower guide are calculated without error. The rotations caused at the lower end of the leg have a small error and the deflections caused at the upper end of the leg also have a small error.

Typical (maximum) hydrodynamic load distributions on a single leg are shown for the generic liftboat on the following page, number A8-2, of this appendix. The upper graph shows load distributions for 65 feet water depth, 20 feet wave height, 10 seconds wave period, and 2 knots current. The three lines on the figure represent maximum load distributions (occurring as the crest passes one leg) calculated by three different wave theories. In this case, the upper curve, representing the Stokes' 3rd order wave theory results, comes closest to the correct conditions. The lower graph on page A8-2 shows the maximum load distributions occurring in the same conditions as the upper curve, but in the absence of current.

Pages A8-3 through A8-5 compare the structural response of an idealized liftboat leg, the top guided and the bottom pin-jointed, to a distributed load corresponding to the upper curve on page A8-2 and to an equivalent point load. The moment induced at the top of the leg is correct. The top deflection is 3.3% different, and the bottom rotation is 5.3% different. Page A8-6 shows the comparison for the maximum distributed loads without current. The differences are virtually identical. Page A8-7 shows a comparison between a uniform vertical load distribution and a point load. The moments are the same at the top of the leg. The deflection caused by the point load is within 4% and the rotation at the bottom of the leg is within 7% of the distributed load value. On page A8-8 results for an extreme case of large positive distributed load at the bottom of the leg, decreasing to a small negative load part way up, are shown. The displacement difference between results is only 4.8% and the rotation difference is less than 6%, while the bending moments are identical.

From these results it is concluded that the errors in approximating distributed leg loads with point loads are negligible.

MAXIMUM HORIZONTAL DRAG FORCE (AT $t=0$)
LIFTBOAT 65FT WD, 20FT/10S WAVE

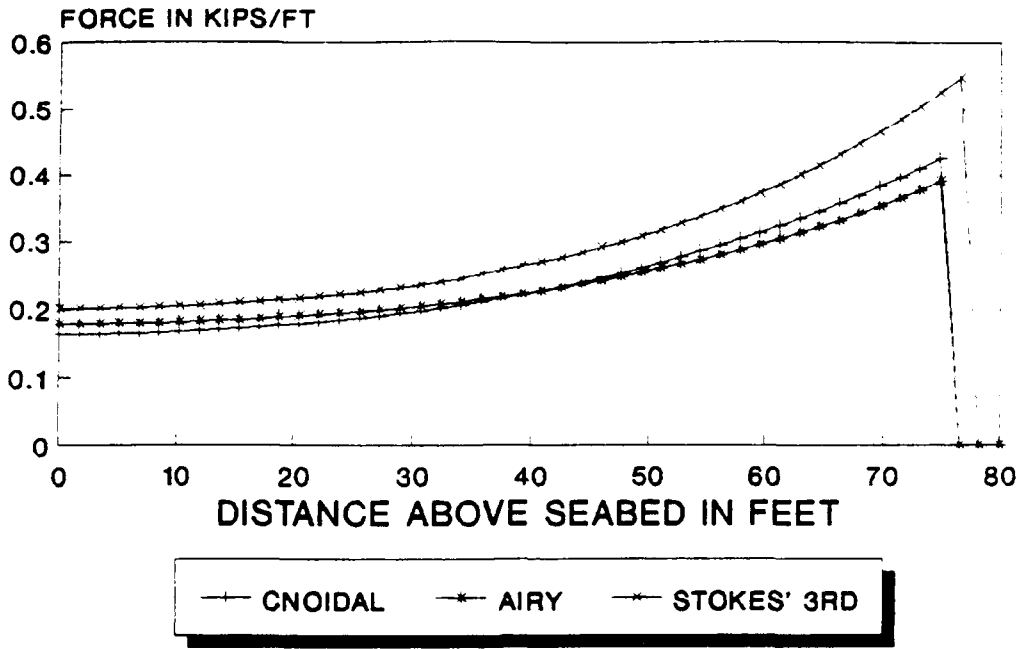

WITH 2 KNOT CURRENT

MAXIMUM HORIZONTAL DRAG FORCE (AT $t=0$)
LIFTBOAT 65FT WD, 20FT/10S WAVE

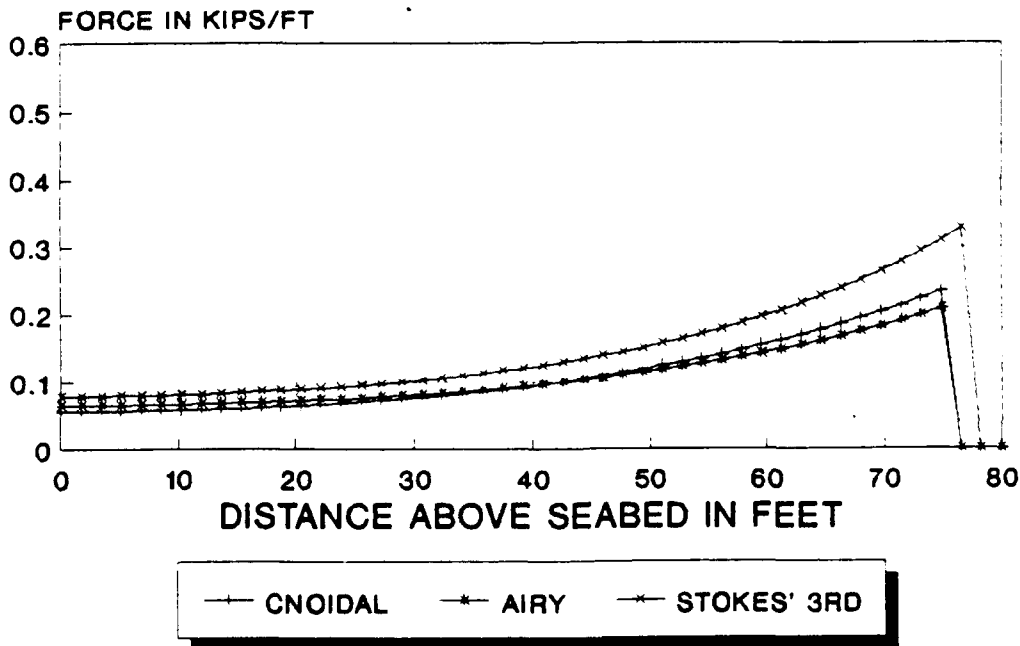

ZERO CURRENT

By W.P. Stewart; March 23, 1990, 1st Revision, July 4, 1990

This file is used to compare the moments, rotations, and deflections in liftboat legs subject to similar end conditions and applied moments, but different load distributions. The purpose is to compare the differences in structural response with an equivalent point load used to simplify the modeling of the global response. For this comparison, the top is guided and the bottom is pin-jointed.

The user specifies a linearly varying load, from some value, w_l , at the bottom of the liftboat leg, to some value, w_a , at a point distance, a , from the top. The program finds an equivalent point load and its center of action. Response, in terms of moments at the top, deflections at the top, and rotations at the bottom, are found for each form of loading and compared.

INPUT VARIABLES

$I := .8897 \cdot \text{ft}^4$	second moment of area of beam
$l := 88 \cdot \text{ft}$	length of beam
$E := 29500 \cdot \text{ksi}$	Young's modulus for beam material
$w_a := .6 \cdot \text{kpf}$	magnitude of distributed load at end a
$w_l := .2 \cdot \text{kpf}$	magnitude of distributed load at end l
$a := 30 \cdot \text{ft}$	distance from end a of distributed load

CALCULATE INTERMEDIATE TERMS

$$W := \frac{w_a + w_l}{2} \cdot (l - a)$$

$W = 23.2 \cdot \text{kip}$ equivalent point load

$$W_l := w_l \cdot (l - a) \cdot \frac{l - a}{2}$$

lateral load component associated with lower load amplitude

$$W_a := (w_a - w_l) \cdot \frac{l - a}{2} \cdot \frac{2 \cdot (l - a)}{3}$$

lateral load component associated with upper load amplitude

$$L := \frac{W_l + W_a}{W}$$

$L = 33.833 \cdot \text{ft}$ effective lever arm from end l of moment caused by distributed load

$A := l - L$
 $A = 54.167 \cdot \text{ft}$ distance of center of action of distributed load from end a

$$MW := W \cdot (1 - A)$$

$$Mw := \frac{wa}{2} \cdot (1 - a)^2 + \frac{wl - wa}{6} \cdot (1 - a)^2$$

MW = 784.933 · kip · ft

moment at top end caused by point load

Mw = 784.933 · kip · ft

moment at top end caused by distributed load

COMPARE END 1 ROTATIONS CAUSED BY BOTH LOAD CASES

$$\theta_W := \frac{W}{2 \cdot E \cdot I} \cdot [1^2 - A^2] \quad \frac{wa}{3 \cdot E \cdot I} \cdot l^3 = 2.066 \cdot \text{deg}$$

$$\theta_w := \frac{wa}{6 \cdot E \cdot I} \cdot (1 - a)^2 \cdot (2 \cdot l + a) + \frac{wl - wa}{24 \cdot E \cdot I} \cdot (1 - a)^2 \cdot (3 \cdot l + a)$$

$\theta_W = 0.846 \cdot \text{deg}$

bottom leg rotation caused by point load

$\theta_w = 0.801 \cdot \text{deg}$

bottom leg rotation caused by distributed load

COMPARE DEFLECTIONS WITH BOTH LOAD CASES

$$y_W := \frac{-(W \cdot (1 - A))}{6 \cdot E \cdot I} \cdot [2 \cdot l^2 + 2 \cdot A \cdot l - A^2]$$

$$y_w := \frac{-wa}{24 \cdot E \cdot I} \cdot (1 - a)^2 \cdot [5 \cdot l^2 + 2 \cdot a \cdot l - a^2] \dots$$

$$+ \frac{-(wl - wa)}{120 \cdot E \cdot I} \cdot (1 - a)^2 \cdot [9 \cdot l^2 + 2 \cdot a \cdot l - a^2]$$

$y_W = -0.765 \cdot \text{ft}$

lateral deflection caused by point load

$y_w = -0.739 \cdot \text{ft}$

lateral deflection caused by distributed load

Calculate difference terms for display below

$$dM := \frac{MW - Mw}{MW} \quad d\theta := \frac{\theta_W - \theta_w}{\theta_W} \quad dy := \frac{y_W - y_w}{y_W}$$

$i := 0 \dots 3$

$x_0 := 0 \cdot \text{ft}$ $x_1 := l - a$ $x_2 := 1.0001 \cdot x_1$ $x_3 := 1$

$w_0 := w_l$ $w_1 := w_a$ $w_2 := 0 \cdot \frac{\text{kip}}{\text{ft}}$ $w_3 := w_2$

RESULTS SUMMARY

Variable	RESULTS for RESPONSE		
	Point Load	Dist. Load	% Difference
Top moment	MW = 784.933 · kip · ft	Mw = 784.933 · kip · ft	dW = 0 · %
Bottom Rotation	$\theta_w = 0.846 \cdot \text{deg}$	$\theta_w = 0.801 \cdot \text{deg}$	d $\theta = 5.342 \cdot \%$
Top deflection	yW = -0.765 · ft	yw = -0.739 · ft	dy = 3.303 · %

Plot User-Defined Load Diagram

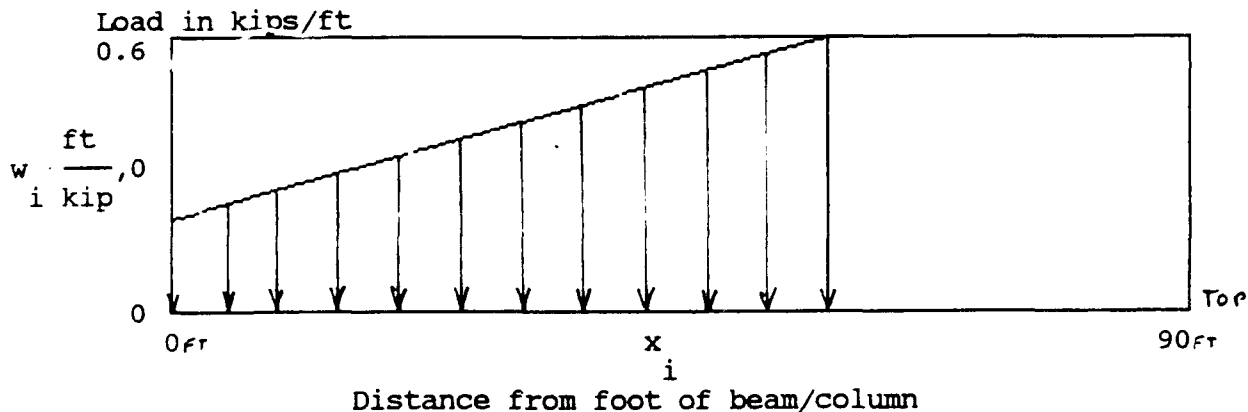

RESULTS SUMMARY

Variable	RESULTS for RESPONSE		
	Point Load	Dist. Load	% Difference
Top moment	MW = 392.467 · kip · ft	Mw = 392.467 · kip · ft	dW = 0 · %
Bottom Rotation	$\theta W = 0.423 \cdot \text{deg}$	$\theta w = 0.4 \cdot \text{deg}$	$d\theta = 5.342 \cdot \%$
Top deflection	yW = -0.382 · ft	yw = -0.37 · ft	dy = 3.303 · %

Plot User-Defined Load Diagram

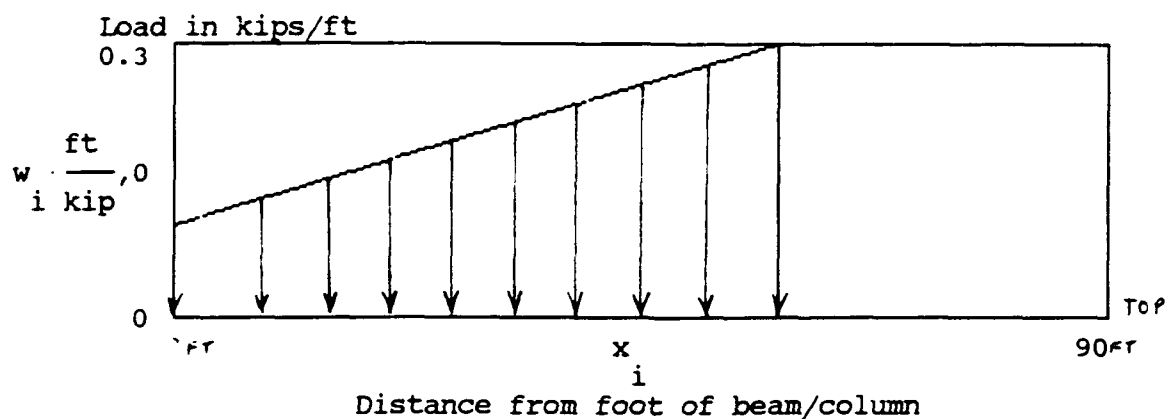

RESULTS SUMMARY

Variable	RESULTS for RESPONSE		
	Point Load	Dist. Load	% Difference
Top moment	MW = 504.6 · kip · ft	Mw = 504.6 · kip · ft	dW = 0 · %
Bottom Rotation	$\theta W = 0.562 \cdot \text{deg}$	$\theta w = 0.525 \cdot \text{deg}$	$d\theta = 6.576 \cdot \%$
Top deflection	yW = -0.498 · ft	yw = -0.48 · ft	dy = 3.756 · %

Plot User-Defined Load Diagram

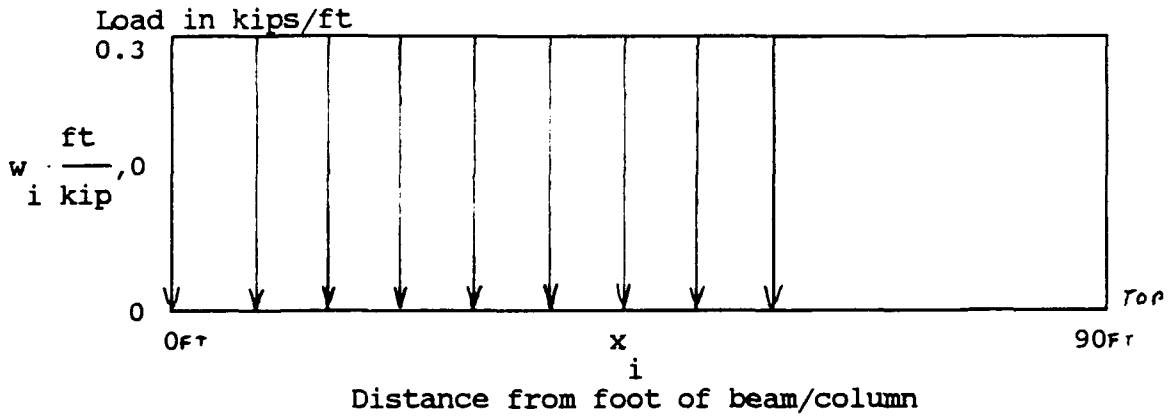

RESULTS SUMMARY

Variable	RESULTS for RESPONSE		
	Point Load	Dist. Load	% Difference
Top moment	MW = 56.067 · kip · ft	Mw = 56.067 · kip · ft	dW = 0 · %
Bottom Rotation	$\theta W = 0.071 \cdot \text{deg}$	$\theta w = 0.075 \cdot \text{deg}$	d $\theta = -5.812 \cdot \%$
Top deflection	yW = -0.057 · ft	yw = -0.06 · ft	dy = -4.765 · %

Plot User-Defined Load Diagram

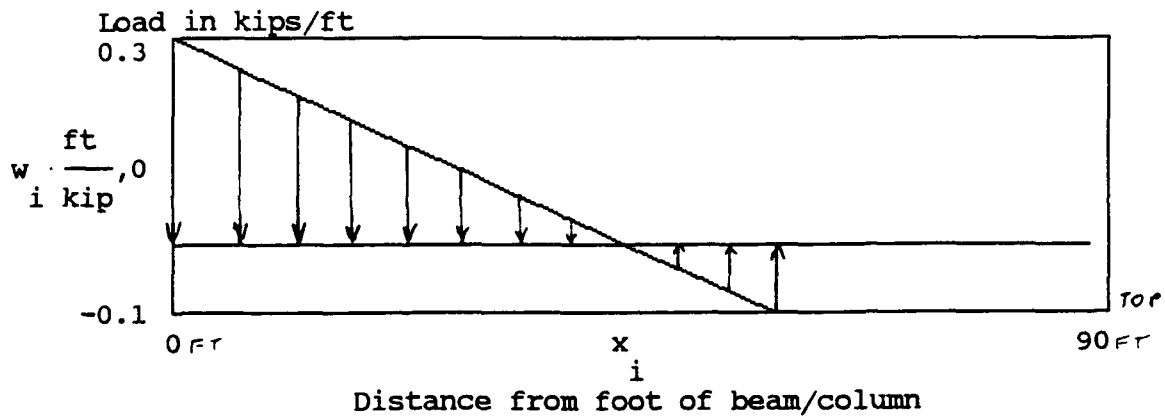

APPENDIX 9

Iterative Solution for P-Delta Effect

This appendix deals with the consequence of the axial load on the legs decreasing the lateral sway stiffness of the liftboat and increasing the lateral deflection of the hull, and leg bending stresses, when lateral loads are imposed. The approach taken in STA LIFTBOAT to calculate deflections and stresses is to use a formulation for the lateral stiffness of the liftboat which accounts for the reduction in stiffness caused by axial loading. An alternative approach is to use the unmodified lateral stiffness of the legs (without consideration of the axial load) to find a first order deflection. A secondary bending moment as a consequence of this deflection and the axial load causes a further deflection. The consequence of this new deflection is to increase the secondary bending moment and the process continues until equilibrium is found.

This appendix compares results from the iterative approach with results from the direct approach to finding leg bending moments and sway deflections. A spreadsheet solution has been implemented, allowing the user to change all important variables and quickly see the final results. On pages A9-3 through A9-9 the input values and results for a typical set of loads on the generic liftboat leg are given. On pages A9-10 through A9-13, graphs comparing the deflections found by the iterative approach with those found by the direct approach are given.

The effect of eccentric axial loading is investigated on pages A9-5 through A9-8, with initial eccentricities of 1 foot, 5 feet, 10 feet, and 15 feet in the x-direction.

With the iterative approach the effect of any initial eccentricity is simply accounted for by an additional top moment given by:

$$M_{ecc1} = P \cdot ecc$$

Where:

M_{ecc1} = additional top moment from eccentricity
 P = axial load applied to leg
 ecc = eccentric distance from leg centerline of load application.

The iterations to find the final lateral deflection start with this top moment. However, with the direct approach, the deflection caused is directly calculated, as is the moment at the top. The moment is given by:

$$M_{eccD} = P.ecc/\cos(kL)$$

Where:

k = coefficient defined on page A9-3
L = leg length

The general agreement between the direct approach and the iterative approach is very good. For the cases presented here, the maximum difference between the two methods is seen in the deflections at the top of the legs, and is not greater than 7%. The maximum difference for bending moments (and hence bending stresses) is generally not greater than 1%. Where the axial leg load is increased by the frame geometry as a consequence of lateral loading (footing reactions increase on the leeward side) the direct method (based on average axial leg loading) appears to underestimate the deflections by just less than 7% and leg moments by just less than 4%. However, this is largely compensated for on the windward leg(s) which have reduced axial loading and therefore have increased sway stiffness. It is estimated that the maximum difference in bending stresses calculated by the two methods should not exceed 2% for the generic liftboat.

Iterative Solution Conclusions

It is concluded from this investigation that the direct method for calculating leg deflections, bending moments, and stresses is satisfactory and significantly more attractive than the iterative approach. Although deflections may be underestimated by around 5%, the use of point loading rather than distributed loading compensates for this small difference (see Appendix 8). Bending stresses are predicted by the two methods to be no more than 2% different.

DEFLECTIONS OF LIFTBOAT LEG SUBJECT TO AXIAL AND LATERAL LOADS

By: W.P. Stewart, March 26, 1990 File: liftit3 Date run: 07/05/90

Run Reference to appear as second title on graph >> Wide Leg Spacing 150/30 90ft 45degrees

This file investigates lateral deflections of a liftboat leg subject to axial and lateral loads. The loading is input as a lateral load, W, and axial load, P. A direct solution for an axially loaded beam is compared with an iterative solution for deflections and moments resulting from the lateral deflection (so-called P-Delta effect). The bottom of the leg is modelled as a pin joint; top is guided.

Deflection caused by lateral loads without axial loading is:

$$x = W(L-a)/(6EI) * (2L * L + 2aL - a * a)$$

In the presence of axial load the deflection caused by lateral loads is:

$$x = W/(kP) * (\sin(k\{L-a\})/\cos(kL) - k(L-a)) \quad k = \text{sqrt}(P/EI)$$

The first equation can be "corrected" by the deflection caused by the secondary moment: $X = x + P * x * L * L / (2EI)$

This causes further secondary moments which cause further deflections, etc.

INPUT TERMS

100000	LEG SPACING. This term dictates how much the axial load increases as the leg deflects.	This file can also be used to investigate the frame effect, where axial load in the vertical members is increased (and decreased) by lateral loads. If it is required to do this, set the LEG SPACING to the desired value for a 2-D frame, say 100 feet. The program will then increase P as follows: $P' = P + WL/(\text{leg spacing}) + P\delta/(2 * \text{leg spacing})$ Note that the Pdelta component, above, is not included in the direct solution for the deflections.
90	L, length in feet	
0.8098	l _{xx} , in ft ⁴	
0.6769	l _{yy} , in ft ⁴	
4248000	E, for steel in kip/sqft	
150	P, axial load in kips	
30	W, lateral load in kips	
0	a, distance from end a of lateral load	
45	theta, lateral load direction in degrees	
0	initial eccentricity in x-direction	
0	initial eccentricity in y-direction	

PRIMARY RESULTS

	diff./direct	diff./final
1.498 x-deflection, uncorrected, ft	14.2%	17.7%
1.793 y-deflection, uncorrected, ft	16.9%	21.1%
1.745 x-deflection direct, ft	the above differences exist between the direct and final results, compared to the uncorrected results	
2.158 y-deflection direct, ft		
1.820 x-deflection final, ft	-4.3% << differences between final iterated results	
2.273 y-deflection final, ft	-5.3% << and direct results for x-, and y-deflections	
2171 M _{xx} direct, ft-kips		
2233 M _{yy} direct, ft-kips		
2182 M _{xx} final, ft-kips	-0.5% << differences between final iterated results	
2250 M _{yy} final, ft-kips	-0.8% << and direct results for M _{xx} and M _{yy} moments	
876 Euler load for leg		
0.00660 k _x k = sqrt(P/EI)	The parameters to the left influence the direct response results, with axial loads	
0.00722 k _y		
150.027 P', with increase caused by frame geometry, = P + WL/(leg spacing)		

TABULAR ITERATIVE RESULTS

X1 = lateral deflection in x-direction caused by lateral load
 Y1 = lateral deflection in y-direction caused by lateral load
 x1 = lateral deflection in x-dirn. caused by axial load
 y1 = lateral deflection in y-dirn. caused by axial load

	iteration	x1	y1	X-tot	Y-tot	X-direct	Y-direct
X1	0	0	0	0	0	0	0
1.49847	1	0	0	1.498477	1.792683	1.745499	2.15820
	2	0.264634	0.378753	1.763112	2.171436	1.745499	2.15820
Y1	3	0.311371	0.458778	1.809849	2.251461	1.745499	2.15820
1.79268	4	0.319626	0.475687	1.818103	2.268370	1.745499	2.15820
	5	0.321083	0.479259	1.819561	2.271942	1.745499	2.15820
	6	0.321341	0.480014	1.819818	2.272697	1.745499	2.15820
	7	0.321386	0.480174	1.819864	2.272857	1.745499	2.15820
	8	0.321394	0.480207	1.819872	2.272890	1.745499	2.15820

DEFLECTIONS OF LIFTBOAT LEG SUBJECT TO AXIAL AND LATERAL LOADS

By: W.P. Stewart, March 26, 1990 File: liftit3 Date run: 07/05/90

Run Reference to appear as second title on graph >> 100 ft Leg Spacing 150/30 90ft 45degrees

This file investigates lateral deflections of a liftboat leg subject to axial and lateral loads. The loading is input as a lateral load, W, and axial load, P. A direct solution for an axially loaded beam is compared with an iterative solution for deflections and moments resulting from the lateral deflection (so-called P-Delta effect). The bottom of the leg is modelled as a pin joint; top is guided.

Deflection caused by lateral loads without axial loading is:

$$x = W(L-a)/(6EI) * (2L * L + 2aL - a * a)$$

In the presence of axial load the deflection caused by lateral loads is:

$$x = W/(kP) * (\sin(k\{L-a\})/\cos(kL) - k(L-a)) \quad k = \text{sqrt}(P/EI)$$

The first equation can be "corrected" by the deflection caused by the secondary moment: $X = x + P * x * L * L / (2EI)$

This causes further secondary moments which cause further deflections, etc.

INPUT TERMS

100	LEG SPACING. This term dictates how much the axial load increases as the leg deflects.
90	L, length in feet
0.8098	lxx, in ft4
0.6769	lyy, in ft4
4248000	E, for steel in kip/sqft
150	P, axial load in kips
30	W, lateral load in kips
0	a, distance from end a of lateral load
45	theta, lateral load direction in degrees
0	initial eccentricity in x-direction
0	initial eccentricity in y-direction

This file can also be used to investigate the frame effect, where axial load in the vertical members is increased (and decreased) by lateral loads. If it is required to do this, set the LEG SPACING to the desired value for a 2-D frame, say 100 feet. The program will then increase P as follows:
 $P' = P + WL/(\text{leg spacing}) + P\delta/(2 * \text{leg spacing})$
 Note that the Pdelta component, above, is not included in the direct solution for the deflections.

PRIMARY RESULTS

	diff./direct	diff./final
1.498 x-deflection, uncorrected, ft	14.2%	18.3%
1.793 y-deflection, uncorrected, ft	16.9%	22.1%
1.745 x-deflection direct, ft	the above differences exist between the direct and final results, compared to the uncorrected results	
2.158 y-deflection direct, ft		
1.834 x-deflection final, ft	-5.1%	<< differences between final iterated results
2.301 y-deflection final, ft	-6.6%	<< and direct results for x-, and y-deflections
2176 Mxx direct, ft-kips		
2239 Myy direct, ft-kips		
2239 Mxx final, ft-kips	-2.9%	<< differences between final iterated results
2323 Myy final, ft-kips	-3.8%	<< and direct results for Mxx and Myy moments
876 Euler load for leg		
0.00660 kx	k = sqrt(P/EI)	
0.00722 ky	The parameters to the left influence the direct response results, with axial loads	
177 P', with increase caused by frame geometry, = P + WL/(leg spacing)		

TABULAR ITERATIVE RESULTS

X1 = lateral deflection in x-direction caused by lateral load
 Y1 = lateral deflection in y-direction caused by lateral load
 x1 = lateral deflection in x-dirn. caused by axial load
 y1 = lateral deflection in y-dirn. caused by axial load

	iteration	x1	y1	X-tot	Y-tot	X-direct	Y-direct
X1	0	0	0	0	0	0	0
1.49847	1	0	0	1.498477	1.792683	1.745499	2.15820
	2	0.272557	0.392318	1.771035	2.185001	1.745499	2.15820
Y1	3	0.323838	0.481797	1.822315	2.274480	1.745499	2.15820
1.79268	4	0.333545	0.502387	1.832022	2.295071	1.745499	2.15820
	5	0.335384	0.507135	1.833862	2.299818	1.745499	2.15820
	6	0.335733	0.508230	1.834210	2.300913	1.745499	2.15820
	7	0.335799	0.508483	1.834276	2.301166	1.745499	2.15820
	8	0.335811	0.508541	1.834289	2.301224	1.745499	2.15820

DEFLECTIONS OF LIFTBOAT LEG SUBJECT TO AXIAL AND LATERAL LOADS

By: W.P. Stewart, March 26, 1990 File: lifit3 Date run: 07/05/90

Run Reference to appear as second title on graph >> Wide Leg Spacing 150/30 90ft 0 degrees

This file investigates lateral deflections of a liftboat leg subject to axial and lateral loads. The loading is input as a lateral load, W, and axial load, P. A direct solution for an axially loaded beam is compared with an iterative solution for deflections and moments resulting from the lateral deflection (so-called P-Delta effect). The bottom of the leg is modelled as a pin joint; top is guided.

Deflection caused by lateral loads without axial loading is:

$$x = W(L-a)/(6EI) * (2L * L + 2aL - a * a)$$

In the presence of axial load the deflection caused by lateral loads is:

$$x = W/(kP) * (\sin(k\{L-a\})/\cos(kL) - k(L-a)) \quad k = \text{sqrt}(P/EI)$$

*The first equation can be "corrected" by the deflection caused by the secondary moment: X = x + P*x*L*L/(2EI)*

This causes further secondary moments which cause further deflections, etc.

INPUT TERMS

100000	LEG SPACING. This term dictates how much the axial load increases as the leg deflects.	This file can also be used to investigate the frame effect, where axial load in the vertical members is increased (and decreased) by lateral loads. If it is required to do this, set the LEG SPACING to the desired value for a 2-D frame, say 100 feet. The program will then increase P as follows: P' = P + WL/(leg spacing) + Pdelta/(2*leg spacing) Note that the Pdelta component, above, is not included in the direct solution for the deflections.
90	L, length in feet	
0.8098	bx, in ft4	
0.6769	lyy, in ft4	
4248000	E, for steel in kip/sqft	
150	P, axial load in kips	
30	W, lateral load in kips	
0	a, distance from end a of lateral load	
0.00000	theta, lateral load direction in degrees	
0	initial eccentricity in x-direction	
0	initial eccentricity in y-direction	

PRIMARY RESULTS

	diff./direct	diff./final
2.119 x-deflection, uncorrected, ft	14.2%	17.7%
0.000 y-deflection, uncorrected, ft	16.9%	21.1%
2.469 x-deflection direct, ft	the above differences exist between the direct and final results, compared to the uncorrected results	
0.000 y-deflection direct, ft		
2.574 x-deflection final, ft	-4.3%	<< differences between final iterated results
0.000 y-deflection final, ft	-5.3%	<< and direct results for x-, and y-deflections
3070 Mxx direct, ft-kips		
0 Myy direct, ft-kips		
3086 Mxx final, ft-kips	-0.5%	<< differences between final iterated results
0 Myy final, ft-kips	-0.8%	<< and direct results for Mxx and Myy moments
876 Euler load for leg		
0.00660 kx	k = sqrt(P/EI)	
0.00722 ky	The parameters to the left influence the direct response results, with axial loads	
150.027 P'	with increase caused by frame geometry, = P + WL/(leg spacing)	

TABULAR ITERATIVE RESULTS

X1 = lateral deflection in x-direction caused by lateral load
 Y1 = lateral deflection in y-direction caused by lateral load
 x1 = lateral deflection in x-dirn. caused by axial load
 y1 = lateral deflection in y-dirn. caused by axial load

	iteration	x1	y1	X-tot	Y-tot	X-direct	Y-direct
X1	0	0	0	0	0	0	0
2.11916	1	0	0	2.119167	0.000000	2.468508	0.000000
	2	0.374255	0.000000	2.493422	0.000000	2.468508	0.000000
Y1	3	0.440353	0.000000	2.559520	0.000000	2.468508	0.000000
0.00000	4	0.452027	0.000000	2.571194	0.000000	2.468508	0.000000
	5	0.454089	0.000000	2.573256	0.000000	2.468508	0.000000
	6	0.454453	0.000000	2.573620	0.000000	2.468508	0.000000
	7	0.454517	0.000000	2.573685	0.000000	2.468508	0.000000
	8	0.454529	0.000000	2.573696	0.000000	2.468508	0.000000

DEFLECTIONS OF LIFTBOAT LEG SUBJECT TO AXIAL AND LATERAL LOADS

By: W.P. Stewart, March 26, 1990 File: liftit3 Date run: 07/05/90

Run Reference to appear as second title on graph >> Wide Leg Spacing 150/30 90/0 1ft eccentric

This file investigates lateral deflections of a liftboat leg subject to axial and lateral loads. The loading is input as a lateral load, W, and axial load, P. A direct solution for an axially loaded beam is compared with an iterative solution for deflections and moments resulting from the lateral deflection (so-called P-Delta effect). The bottom of the leg is modelled as a pin joint; top is guided.

Deflection caused by lateral loads without axial loading is:

$$x = W(L-a)/(6EI) * (2L * L + 2aL - a * a)$$

In the presence of axial load the deflection caused by lateral loads is:

$$x = W/(kP) * (\sin(k\{L-a\})/\cos(kL) - k(L-a)) \quad k = \text{sqrt}(P/EI)$$

*The first equation can be "corrected" by the deflection caused by the secondary moment: $X = x + P * x * L * L / (2EI)$*

This causes further secondary moments which cause further deflections, etc.

INPUT TERMS

100000 LEG SPACING. This term dictates how much the axial load increases as the leg deflects.	
90 L, length in feet	This file can also be used to investigate the frame effect, where axial load in the vertical members is increased (and decreased) by lateral loads. If it is required to do this, set the LEG SPACING to the desired value for a 2-D frame, say 100 feet. The program will then increase P as follows: $P' = P + WL(\text{leg spacing}) + P\delta / (2 * \text{leg spacing})$ Note that the Pdelta component, above, is not included in the direct solution for the deflections.
0.8098 lxx, in ft4	
0.6769 lyy, in ft4	
4248000 E, for steel in kip/sqft	
150 P, axial load in kips	
30 W, lateral load in kips	
0 a, distance from end a of lateral load	
0.00000 theta, lateral load direction in degrees	
1 initial eccentricity in x-direction	
0 initial eccentricity in y-direction	

PRIMARY RESULTS

	diff./direct	diff./final
2.119 x-deflection, uncorrected, ft	20.8%	24.0%
0.000 y-deflection, uncorrected, ft	16.9%	21.1%
2.675 x-deflection direct, ft	the above differences exist between the direct and final results, compared to the uncorrected results	
0.000 y-deflection direct, ft		
2.788 x-deflection final, ft	-4.2% << differences between final iterated results	
0.000 y-deflection final, ft	-5.3% << and direct results for x-, and y-deflections	
3251 Mxx direct, ft-kips		
0 Myy direct, ft-kips		
3268 Mxx final, ft-kips	-0.5% << differences between final iterated results	
0 Myy final, ft-kips	-0.8% << and direct results for Mxx and Myy moments	
876 Euler load for leg		
0.00660 kx k = sqrt(P/EI)	The parameters to the left influence the direct response results, with axial loads	
0.00722 ky		
150.027 P', with increase caused by frame geometry, = P + WL/(leg spacing)		

TABULAR ITERATIVE RESULTS

X1 = lateral deflection in x-direction caused by lateral load
 Y1 = lateral deflection in y-direction caused by lateral load
 x1 = lateral deflection in x-dirn. caused by axial load
 y1 = lateral deflection in y-dirn. caused by axial load

	iteration	x1	y1	X-tot	Y-tot	X-direct	Y-direct
X1	0	0	0	0	0	0	0
2.11916	1	0.176597	0	2.295764	0.000000	2.675451	0.000000
	2	0.582049	0.000000	2.701217	0.000000	2.675451	0.000000
Y1	3	0.653660	0.000000	2.772827	0.000000	2.675451	0.000000
	4	0.666308	0.000000	2.785475	0.000000	2.675451	0.000000
0.00000	5	0.668541	0.000000	2.787709	0.000000	2.675451	0.000000
	6	0.668936	0.000000	2.788103	0.000000	2.675451	0.000000
	7	0.669006	0.000000	2.788173	0.000000	2.675451	0.000000
	8	0.669018	0.000000	2.788185	0.000000	2.675451	0.000000

DEFLECTIONS OF LIFTBOAT LEG SUBJECT TO AXIAL AND LATERAL LOADS

By: W.P. Stewart, March 26, 1990 File: liftit3 Date run: 07/05/90

Run Reference to appear as second title on graph >> Wide Leg Spacing 150/30 90/0 5ft eccentric

This file investigates lateral deflections of a liftboat leg subject to axial and lateral loads. The loading is input as a lateral load, W, and axial load, P. A direct solution for an axially loaded beam is compared with an iterative solution for deflections and moments resulting from the lateral deflection (so-called P-Delta effect). The bottom of the leg is modelled as a pin joint; top is guided.

Deflection caused by lateral loads without axial loading is:

$$x = W(L-a)/(6EI) * (2L * L + 2aL - a * a)$$

In the presence of axial load the deflection caused by lateral loads is:

$$x = W/(kP) * (\sin(k \{L-a\}) / \cos(kL) - k(L-a)) \quad k = \text{sqrt}(P/EI)$$

*The first equation can be "corrected" by the deflection caused by the secondary moment: X = x + P * x * L * L / (2EI)*

This causes further secondary moments which cause further deflections, etc.

INPUT TERMS

100000	LEG SPACING. This term dictates how much the axial load increases as the leg deflects.	This file can also be used to investigate the frame effect, where axial load in the vertical members is increased (and decreased) by lateral loads. If it is required to do this, set the LEG SPACING to the desired value for a 2-D frame, say 100 feet. The program will then increase P as follows: $P' = P + WL/(\text{leg spacing}) + P\delta/(2 * \text{leg spacing})$ Note that the Pdelta component, above, is not included in the direct solution for the deflections.
90	L, length in feet	
0.8098	lxx, in ft4	
0.6769	lyy, in ft4	
4248000	E, for steel in kip/sqft	
150	P, axial load in kips	
30	W, lateral load in kips	
0	a, distance from end a of lateral load	
0.00000	theta, lateral load direction in degrees	
5	initial eccentricity in x-direction	
0	initial eccentricity in y-direction	

PRIMARY RESULTS

	diff./direct	diff./final
2.119 x-deflection, uncorrected, ft	39.5%	41.9%
0.000 y-deflection, uncorrected, ft	16.9%	21.1%
3.503 x-deflection direct, ft	the above differences exist between the direct and final results, compared to the uncorrected results	
0.000 y-deflection direct, ft		
3.646 x-deflection final, ft	-4.1%	<< differences between final iterated results
0.000 y-deflection final, ft	-5.3%	<< and direct results for x-, and y-deflections
3976 Mxx direct, ft-kips		
0 Myy direct, ft-kips		
3997 Mxx final, ft-kips	-0.5%	<< differences between final iterated results
0 Myy final, ft-kips	-0.8%	<< and direct results for Mxx and Myy moments
876 Euler load for leg		
0.00660 kx k = sqrt(P/EI)	The parameters to the left influence the direct response results, with axial loads	
0.00722 ky		
150.027 P', with increase caused by frame geometry, = P + WL/(leg spacing)		

TABULAR ITERATIVE RESULTS

X1 = lateral deflection in x-direction caused by lateral load
 Y1 = lateral deflection in y-direction caused by lateral load
 x1 = lateral deflection in x-dirn. caused by axial load
 y1 = lateral deflection in y-dirn. caused by axial load

	iteration	x1	y1	X-tot	Y-tot	X-direct	Y-direct
X1	0	0	0	0	0	0	0
2.11916	1	0.882986	0	3.002153	0.000000	3.503222	0.000000
	2	1.413243	0.000000	3.532410	0.000000	3.503222	0.000000
Y1	3	1.506906	0.000000	3.626074	0.000000	3.503222	0.000000
	4	1.523451	0.000000	3.642619	0.000000	3.503222	0.000000
0.00000	5	1.526374	0.000000	3.645541	0.000000	3.503222	0.000000
	6	1.526890	0.000000	3.646057	0.000000	3.503222	0.000000
	7	1.526981	0.000000	3.646148	0.000000	3.503222	0.000000
	8	1.526997	0.000000	3.646165	0.000000	3.503222	0.000000

DEFLECTIONS OF LIFTBOAT LEG SUBJECT TO AXIAL AND LATERAL LOADS

By: W.P. Stewart, March 26, 1990 File: liftit3 Date run: 07/05/90

Run Reference to appear as second title on graph >> Wide Leg Spacing 150/30 90/0 10ft eccentric

This file investigates lateral deflections of a liftboat leg subject to axial and lateral loads. The loading is input as a lateral load, W, and axial load, P. A direct solution for an axially loaded beam is compared with an iterative solution for deflections and moments resulting from the lateral deflection (so-called P-Delta effect). The bottom of the leg is modelled as a pin joint; top is guided.

Deflection caused by lateral loads without axial loading is:

$$x = W(L-a)/(6EI) * (2L * L + 2aL - a * a)$$

In the presence of axial load the deflection caused by lateral loads is:

$$x = W/(kP) * (\sin(k\{L-a\})/\cos(kL) - k(L-a)) \quad k = \text{sqrt}(P/EI)$$

*The first equation can be "corrected" by the deflection caused by the secondary moment: X = x + P*x*L*L/(2EI)*

This causes further secondary moments which cause further deflections, etc.

INPUT TERMS

100000	LEG SPACING. This term dictates how much the axial load increases as the leg deflects.	This file can also be used to investigate the frame effect, where axial load in the vertical members is increased (and decreased) by lateral loads. If it is required to do this, set the LEG SPACING to the desired value for a 2-D frame, say 100 feet. The program will then increase P as follows: P' = P + WL/(leg spacing) + Pdelta/(2*leg spacing) Note that the Pdelta component, above, is not included in the direct solution for the deflections.
90	L, length in feet	
0.8098	lxx, in ft4	
0.6769	lyy, in ft4	
4248000	E, for steel in kip/sqft	
150	P, axial load in kips	
30	W, lateral load in kips	
0	a, distance from end a of lateral load	
0.00000	theta, lateral load direction in degrees	
10	initial eccentricity in x-direction	
0	initial eccentricity in y-direction	

PRIMARY RESULTS

	diff./direct	diff./final
2.119 x-deflection, uncorrected, ft	53.3%	55.1%
0.000 y-deflection, uncorrected, ft	16.9%	21.1%
4.538 x-deflection direct, ft	the above differences exist between the direct and final results, compared to the uncorrected results	
0.000 y-deflection direct, ft		
4.719 x-deflection final, ft	-4.0% << differences between final iterated results	
0.000 y-deflection final, ft	-5.3% << and direct results for x-, and y-deflections	
4881 Mxx direct, ft-kips		
0 Myy direct, ft-kips		
4908 Mxx final, ft-kips	-0.6% << differences between final iterated results	
0 Myy final, ft-kips	-0.8% << and direct results for Mxx and Myy moments	
876 Euler load for leg		
0.00660 kx k = sqrt(P/Ei)	The parameters to the left influence the direct response results, with axial loads	
0.00722 ky		
150.027 P', with increase caused by frame geometry, = P + WL/(leg spacing)		

TABULAR ITERATIVE RESULTS

X1 = lateral deflection in x-direction caused by lateral load
 Y1 = lateral deflection in y-direction caused by lateral load
 x1 = lateral deflection in x-dirn. caused by axial load
 y1 = lateral deflection in y-dirn. caused by axial load

	iteration	x1	y1	X-tot	Y-tot	X-direct	Y-direct
X1	0	0	0	0	0	0	0
	2.11916	1	1.765972	0	3.885140	0.000000	4.537936
Y1		2	2.452268	0.000000	4.571435	0.000000	4.537936
		3	2.573511	0.000000	4.692678	0.000000	4.537936
		4	2.594930	0.000000	4.714097	0.000000	4.537936
		5	2.598714	0.000000	4.717881	0.000000	4.537936
		6	2.599383	0.000000	4.718550	0.000000	4.537936
		7	2.599501	0.000000	4.718668	0.000000	4.537936
		8	2.599522	0.000000	4.718689	0.000000	4.537936

DEFLECTIONS OF LIFTBOAT LEG SUBJECT TO AXIAL AND LATERAL LOADS

By: W P Stewart, March 26, 1990 File: liftit3 Date run: 07/05/90

Run Reference to appear as second title on graph >> Wide Leg Spacing 150/30 90/0 15ft eccentric

This file investigates lateral deflections of a liftboat leg subject to axial and lateral loads. The loading is input as a lateral load, W, and axial load, P. A direct solution for an axially loaded beam is compared with an iterative solution for deflections and moments resulting from the lateral deflection (so-called P-Delta effect). The bottom of the leg is modelled as a pin joint; top is guided.

Deflection caused by lateral loads without axial loading is:

$$x = W(L-a)/(6EI) * (2L * L + 2aL - a * a)$$

In the presence of axial load the deflection caused by lateral loads is:

$$x = W/(kP) * (\sin(k\{L-a\})/\cos(kL) - k(L-a)) \quad k = \text{sqrt}(P/EI)$$

*The first equation can be "corrected" by the deflection caused by the secondary moment: X = x + P*x*L*L/(2EI)*

This causes further secondary moments which cause further deflections, etc.

INPUT TERMS

100000	LEG SPACING. This term dictates how much the axial load increases as the leg deflects.	This file can also be used to investigate the frame effect, where axial load in the vertical members is increased (and decreased) by lateral loads. If it is required to do this, set the LEG SPACING to the desired value for a 2-D frame, say 100 feet. The program will then increase P as follows: P' = P + WL/(leg spacing) + Pdelta/(2*leg spacing) Note that the Pdelta component, above, is not included in the direct solution for the deflections.
90	L, length in feet	
0.8098	lxx, in ft4	
0.6769	lyy, in ft4	
4248000	E, for steel in kip/sqft	
150	P, axial load in kips	
30	W, lateral load in kips	
0	a, distance from end a of lateral load	
0.00000	theta, lateral load direction in degrees	
15	initial eccentricity in x-direction	
0	initial eccentricity in y-direction	

PRIMARY RESULTS

	diff./direct	diff./final
2.119 x-deflection, uncorrected, ft	62.0%	63.4%
0.000 y-deflection, uncorrected, ft	16.9%	21.1%
5.573 x-deflection direct, ft	the above differences exist between the direct and final results, compared to the uncorrected results	
0.000 y-deflection direct, ft		
5.791 x-deflection final, ft	-3.9%	<< differences between final iterated results
0.000 y-deflection final, ft	-5.3%	<< and direct results for x-, and y-deflections
5786 Mxx direct, ft-kips		
0 Myy direct, ft-kips		
5819 Mxx final, ft-kips	-0.6%	<< differences between final iterated results
0 Myy final, ft-kips	-0.8%	<< and direct results for Mxx and Myy moments
876 Euler load for leg		
0.00660 kx	k = sqrt(P/EI)	
0.00722 ky	The parameters to the left influence the direct response results, with axial loads	
150.027 P', with increase caused by frame geometry, = P + WL/(leg spacing)		

TABULAR ITERATIVE RESULTS

X1 = lateral deflection in x-direction caused by lateral load
 Y1 = lateral deflection in y-direction caused by lateral load
 x1 = lateral deflection in x-dirn. caused by axial load
 y1 = lateral deflection in y-dirn. caused by axial load

	iteration	x1	y1	X-tot	Y-tot	X-direct	Y-direct
X1	0	0	0	0	0	0	0
2.11916	1	2.648959	0	4.768126	0.000000	5.572650	0.000000
	2	3.491330	0.000000	5.610497	0.000000	5.572650	0.000000
Y1	3	3.640166	0.000000	5.759333	0.000000	5.572650	0.000000
0.00000	4	3.666464	0.000000	5.785631	0.000000	5.572650	0.000000
	5	3.671110	0.000000	5.790277	0.000000	5.572650	0.000000
	6	3.671931	0.000000	5.791098	0.000000	5.572650	0.000000
	7	3.672076	0.000000	5.791244	0.000000	5.572650	0.000000
	8	3.672102	0.000000	5.791269	0.000000	5.572650	0.000000

ITERATIONS TO REACH EQUILIBRIUM DEFLN.

Wide Leg Spacing 150/30 90ft 45degrees

LATERAL DEFLECTION

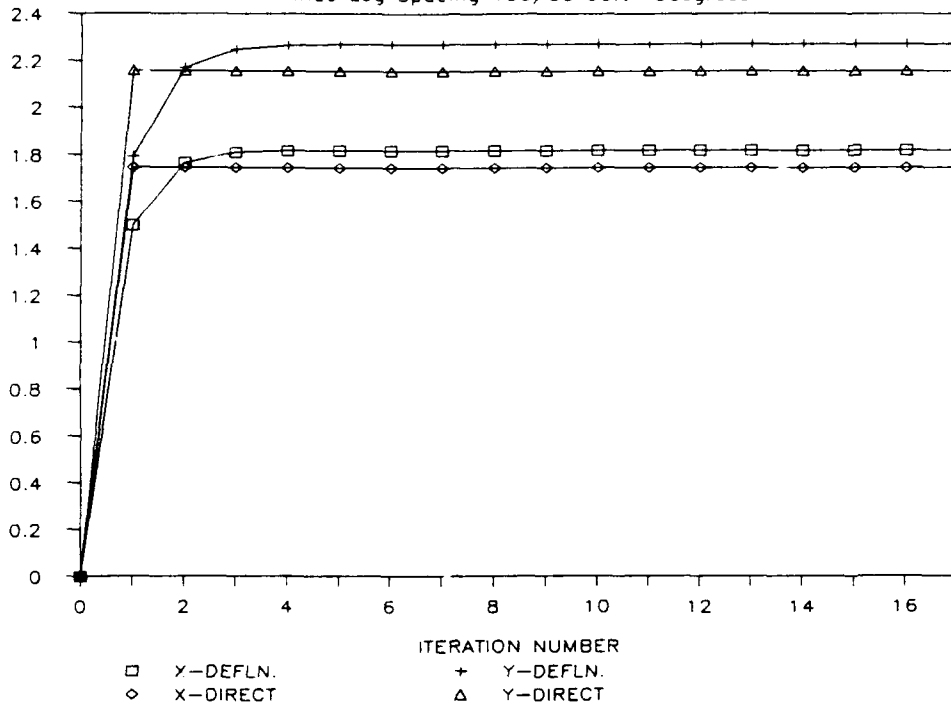

ITERATIONS TO REACH EQUILIBRIUM DEFLN.

100 ft Leg Spacing 150/30 90ft 45degrees

LATERAL DEFLECTION

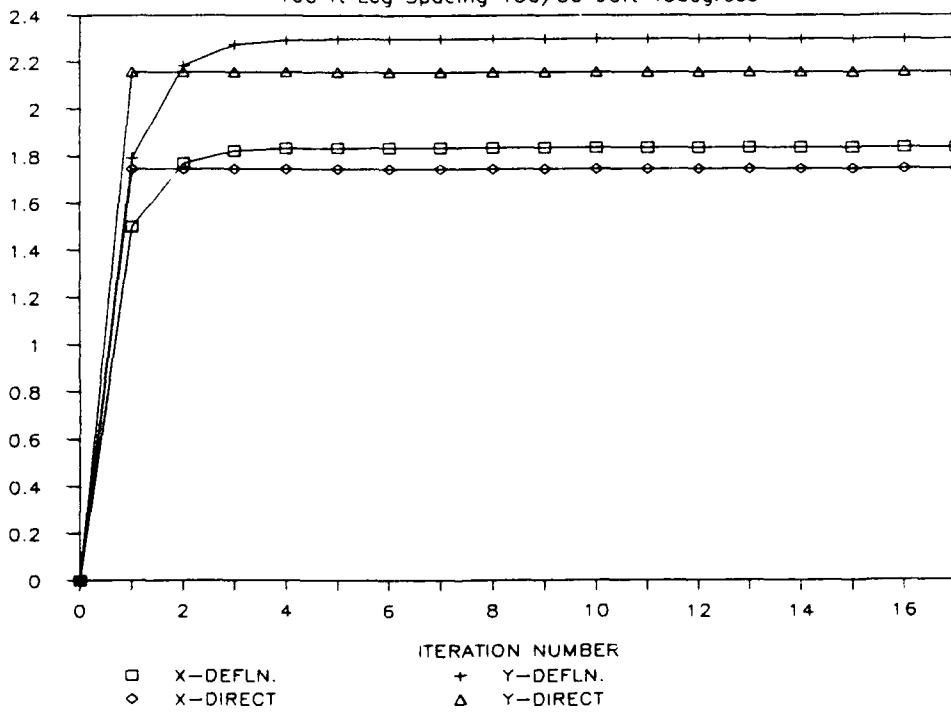

ITERATIONS TO REACH EQUILIBRIUM DEFLN.

Wide Leg Spacing 150/30 90ft 0 degrees

LATERAL DEFLECTION

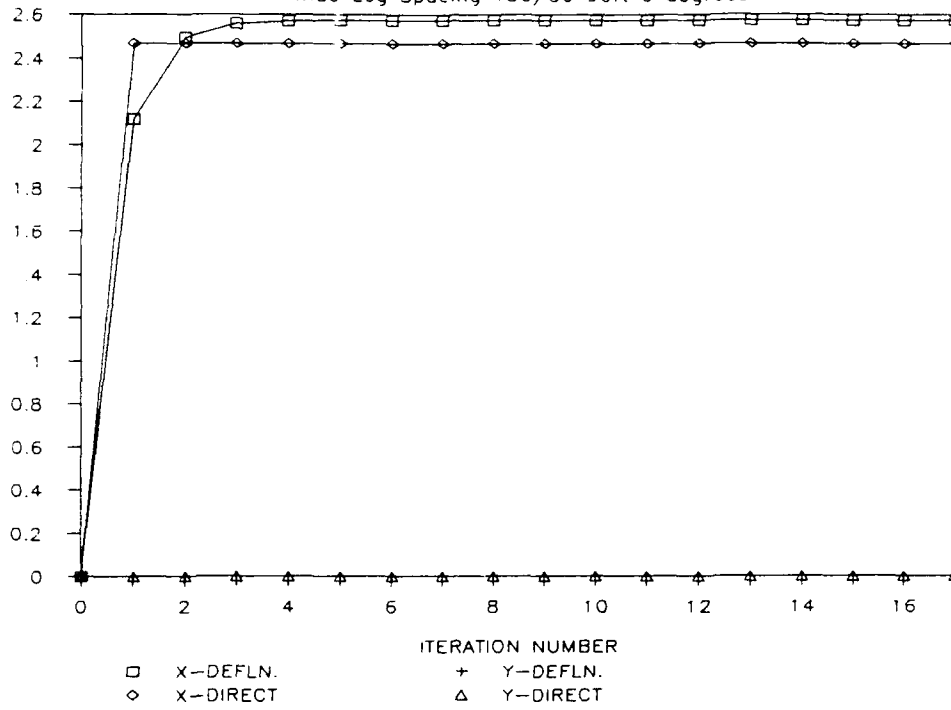

ITERATIONS TO REACH EQUILIBRIUM DEFLN.

Wide Leg Spacing 150/30 90/0 1ft eccentric

LATERAL DEFLECTION

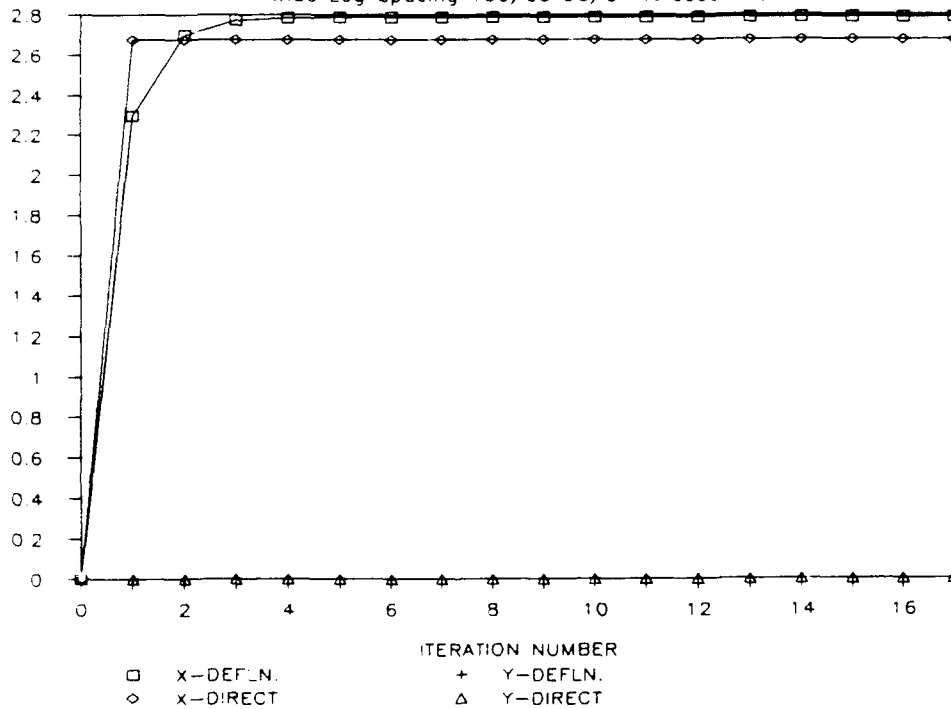

ITERATIONS TO REACH EQUILIBRIUM DEFLN.

LATERAL DEFLECTION

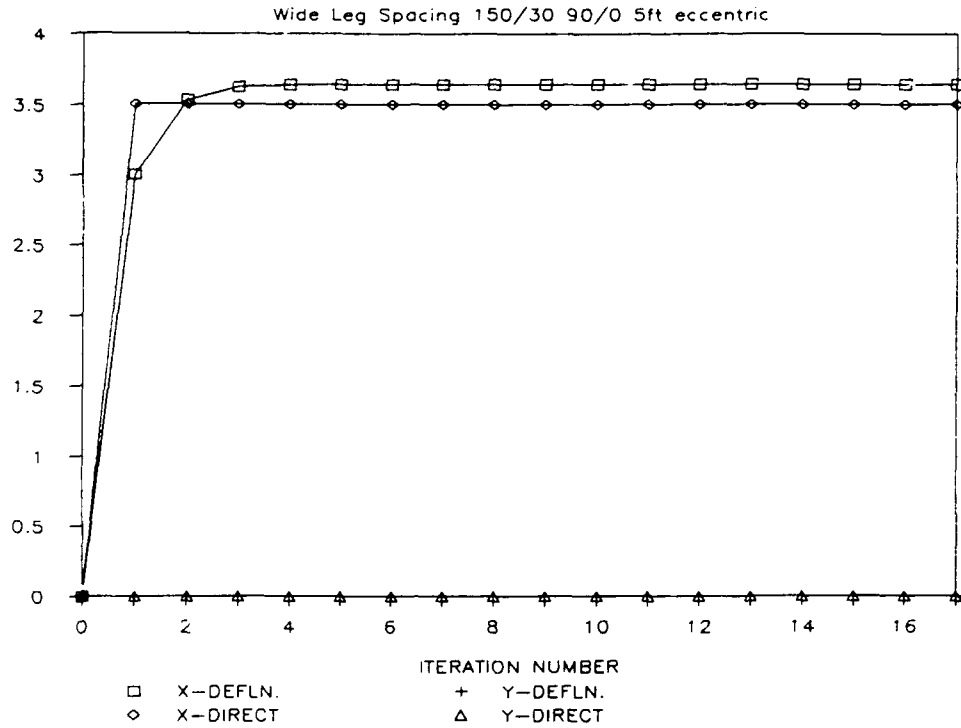

ITERATIONS TO REACH EQUILIBRIUM DEFLN.

LATERAL DEFLECTION

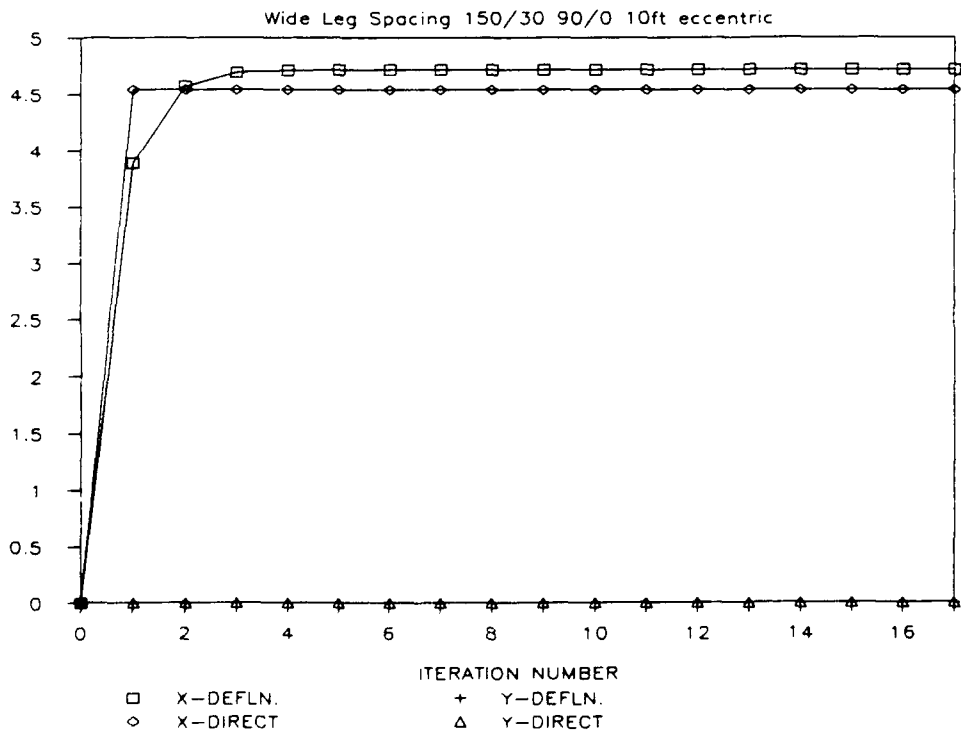

ITERATIONS TO REACH EQUILIBRIUM DEFLN.

Wide Leg Spacing 150/30 90/0 15ft eccentric

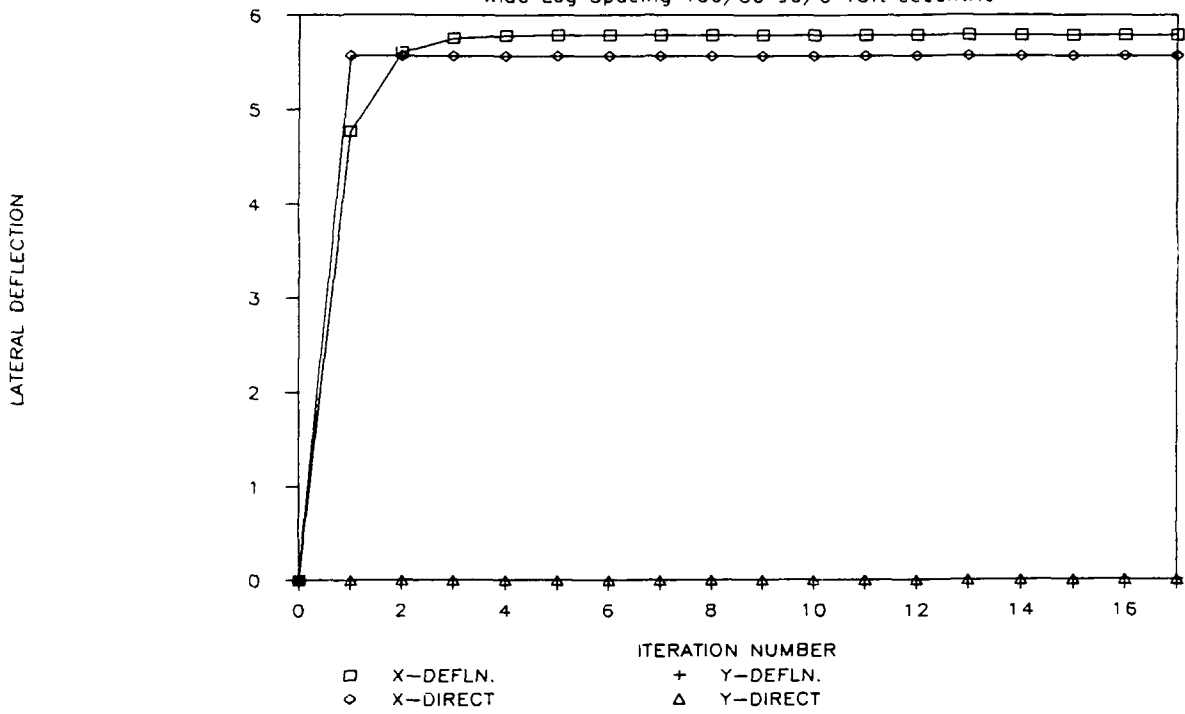

APPENDIX 10

Single Rack Eccentricity Effects

In Section 3.4 the effects of having the pinion loads applied to a liftboat leg via a single rack, as opposed to having symmetric loading applied to a diametrically opposed pair of racks, are described. The behavior of the leg between the guides is not as might be predicted by simple beam analogies, as is shown by the stress contours on a finite element idealization of the upper part of one leg presented in this appendix.

In each of the five figures in this appendix the load case is a total of 300 kips vertical load applied at either two or three nodes on a beam representing the rack, attached to the face of the leg cylinder. Inside the opposite leg face is another beam representing the stiffening in the generic liftboat leg shown in Figure 4 of this report. All vertical reaction of the load is at the base of the leg which is modeled as a pinned connection.

The upper 28 feet of the 42 inch (outer diameter) leg is modeled with 200 3-D thin shell elements with 3-D general purpose beam elements representing the rack and internal longitudinal stiffeners. The lower 74 feet of the leg are modeled with a pipe beam element. Rigid link kinematic constraints are used to attach the lower plate nodes to the top pipe beam node so that pipe flexure at this point is correctly modeled.

Lateral reactions at the upper and lower guides were initially modeled by constraining selected nodes on the plate model to have zero displacement freedom in the x-direction. This is the case in Figures A10-1 and A10-2. An improved model of the guides is shown in Figures A10-3 through A10-5, where small beams are used to react nodal forces in the area of the guides back to a single ground point. Because the beams have the same cross section but different lengths, the central nodes at the guide feel a stiffer x-direction support than the outer nodes. This approximates the real conditions in the area of the guides, although the modelling could still be significantly improved in this area.

The first two figures show isometric views of the leg modeled with 1/2 inch wall thickness. The last three figures show results for a 1 inch wall thickness leg. The colors indicate stress intensity, and in all but one case it is Von Mises combined stress at the top or bottom layer which is reported, as noted on the figures. The horizontal reactions at the guides are noted on the figures and can be compared with reactions of 38.1 kips (top and bottom) that would be predicted by a simple beam model.

The important point to note is that the stresses in the area of the lower guide are significantly lower than would be predicted by assuming a condition of uniform axial stress plus a bending stress that would result from the apparent applied moment (300 kips multiplied by a lever arm of 21 inches in this case). Refer to Section 3.4 for further explanation of the stresses.

The high axial stress in the plate elements immediately below the pinions dictates that the pinions should be designed to be as far above the lower guide area as is reasonably possible. This permits the axial stresses to dissipate around the leg above the lower guide and reduces the maximum combined total stress condition at the lower guide when environmental loading occurs. It can also be seen that a second rack on the opposite side of the leg, in order to share the pinion loads more equally on the leg would be advantageous.

EMRC - DISPLAY II POST-PROCESSOR VER 90.0 Jan 2-91

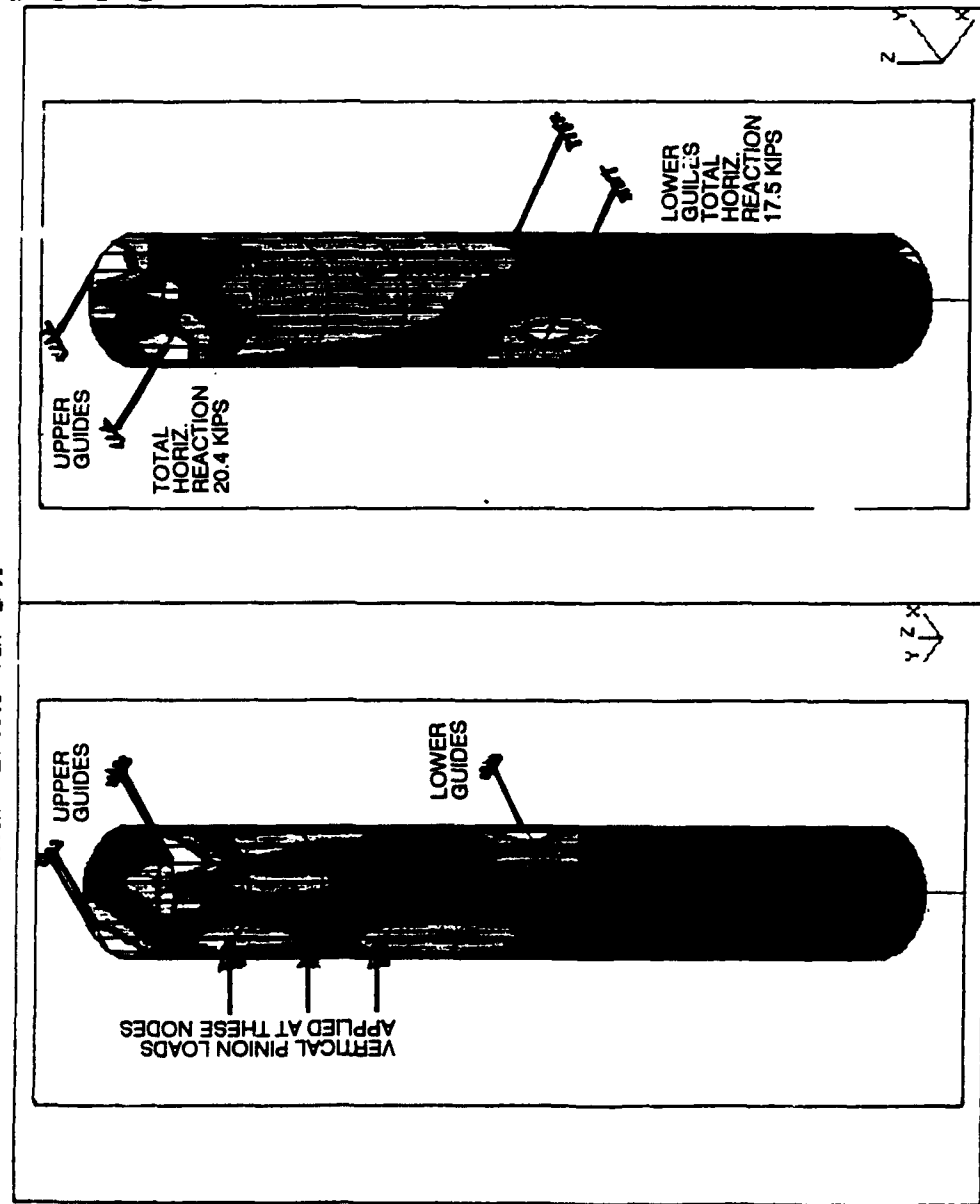

STRESS CONTOURS
VON-MISES STRESS
UTEM : 0.00E+00
RANGE: 1.48E+04

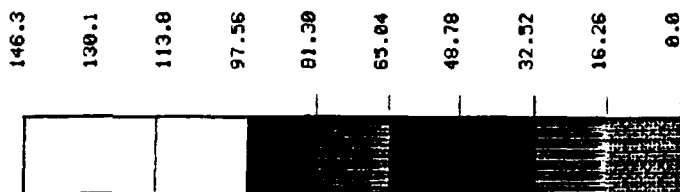

LB011 LINEAR ANALYSIS OF LIFTBOAT LEG SHELL

TOP LAYER

FIGURE A10-1
Run LB04 with 1/2" walls and "hard" guides

COLORLED VERSIONS OF FIGURES A10-1 THROUGH A10-5
ARE AVAILABLE FROM THE COAST GUARD R&D CENTER

ENRC - DISPLAY II POST-PROCESSOR VER 90.0 JANV 2/91

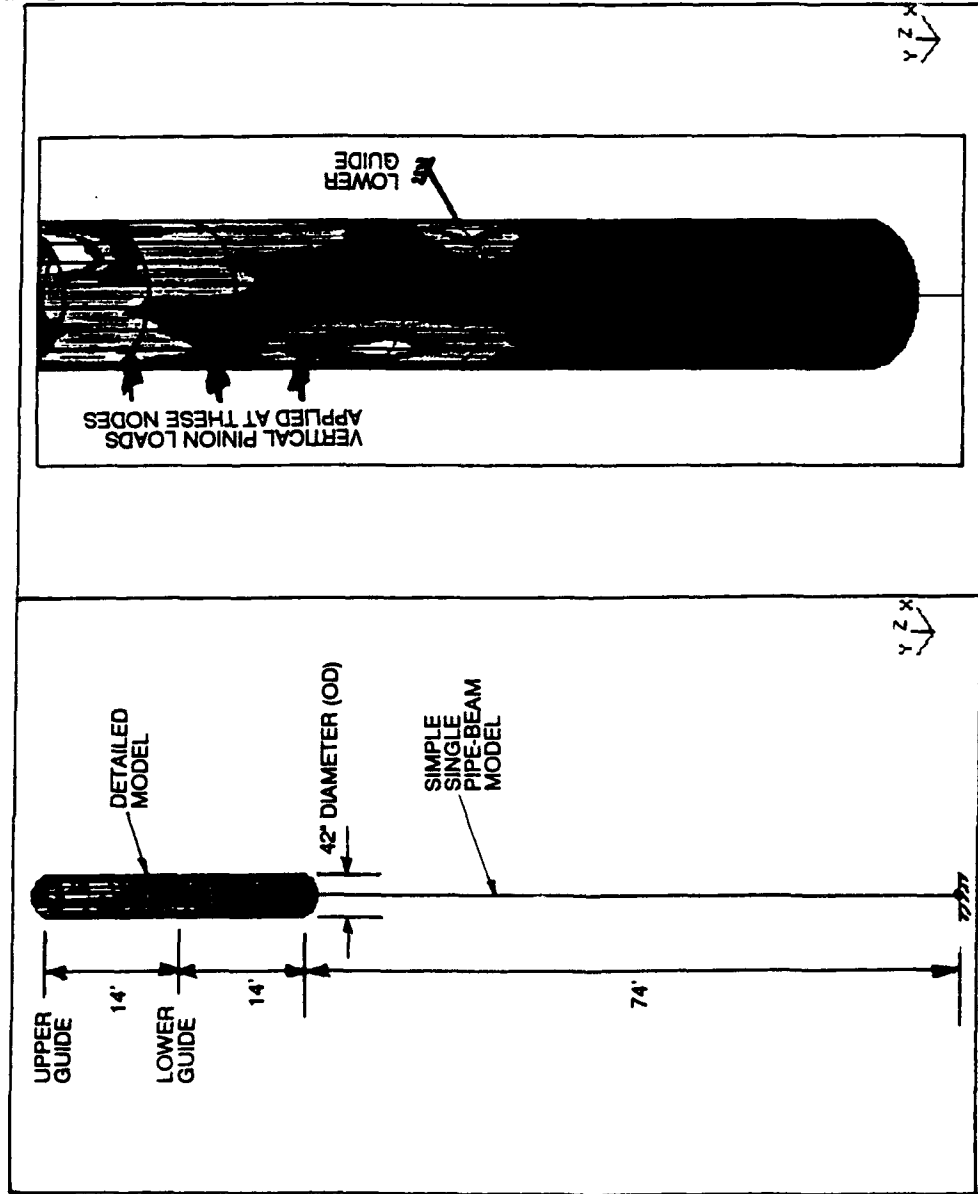

STRESS CONTOURS
 VON-MISES STRESS
 UTEM : 0.00E+00
 RANGE: 1.49E+04

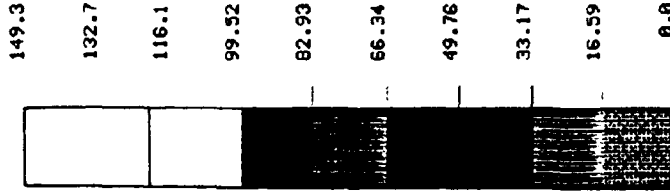

LB011 LINEAR ANALYSIS OF LIFTBOAT LEG SHELL

BOTTOM LAYER

FIGURE A10-2
 Run LB04 with 1/2" walls and "hard" guides

COLORED VERSIONS OF FIGURES A10-1 THROUGH A10-5
 ARE AVAILABLE FROM THE COAST GUARD R&D CENTER

EHRC - DISPLAY II POST-PROCESSOR VER 90.8 Janv 3/91

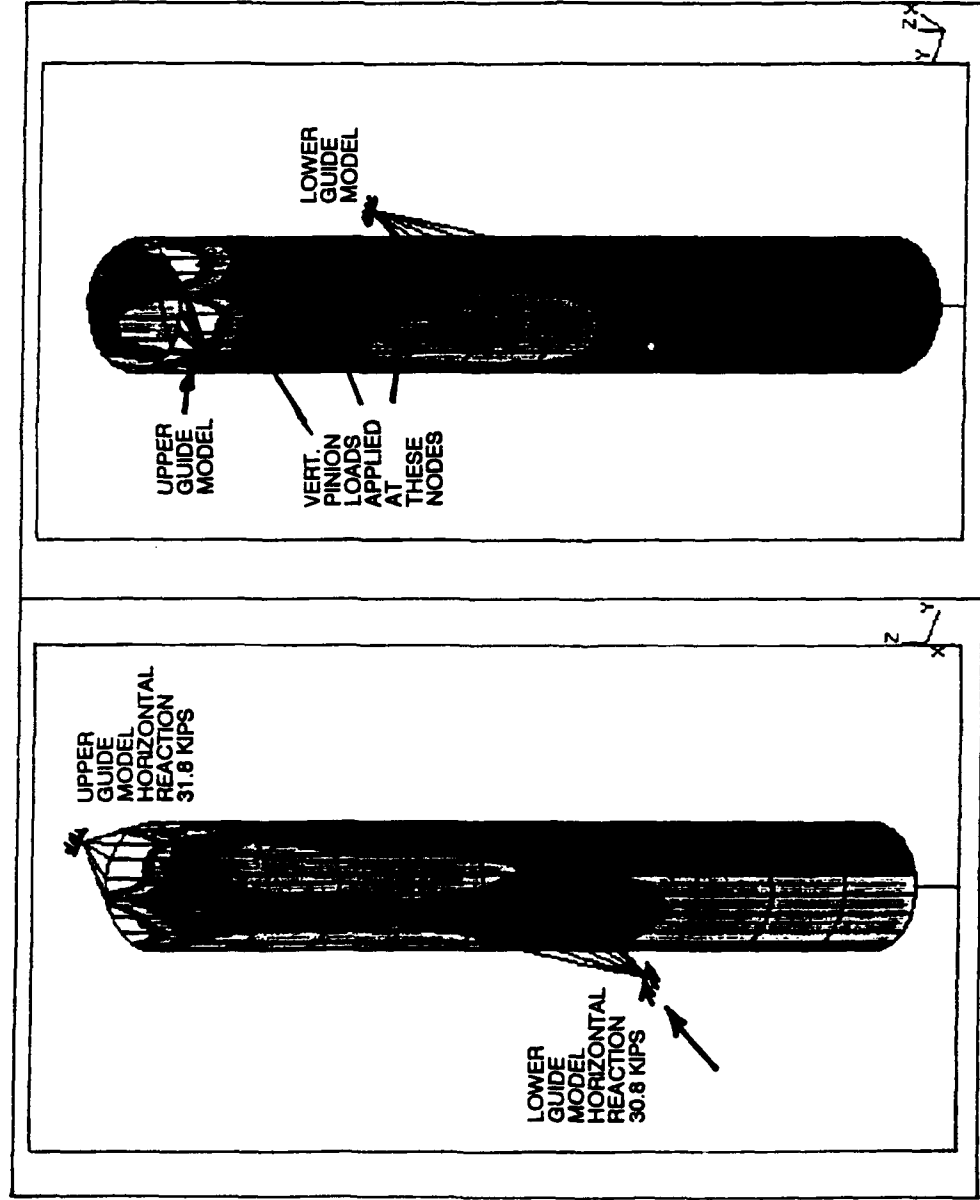

LB011 LINEAR ANALYSIS OF LIFTBOAT LEG SHELL

TOP LAYER

FIGURE A10-3

Run LB05 with 1" walls & improved guide modelling

COLOR VERSIONS OF FIGURES A10-1 THROUGH A10-5 ARE AVAILABLE FROM THE COAST GUARD R&D CENTER

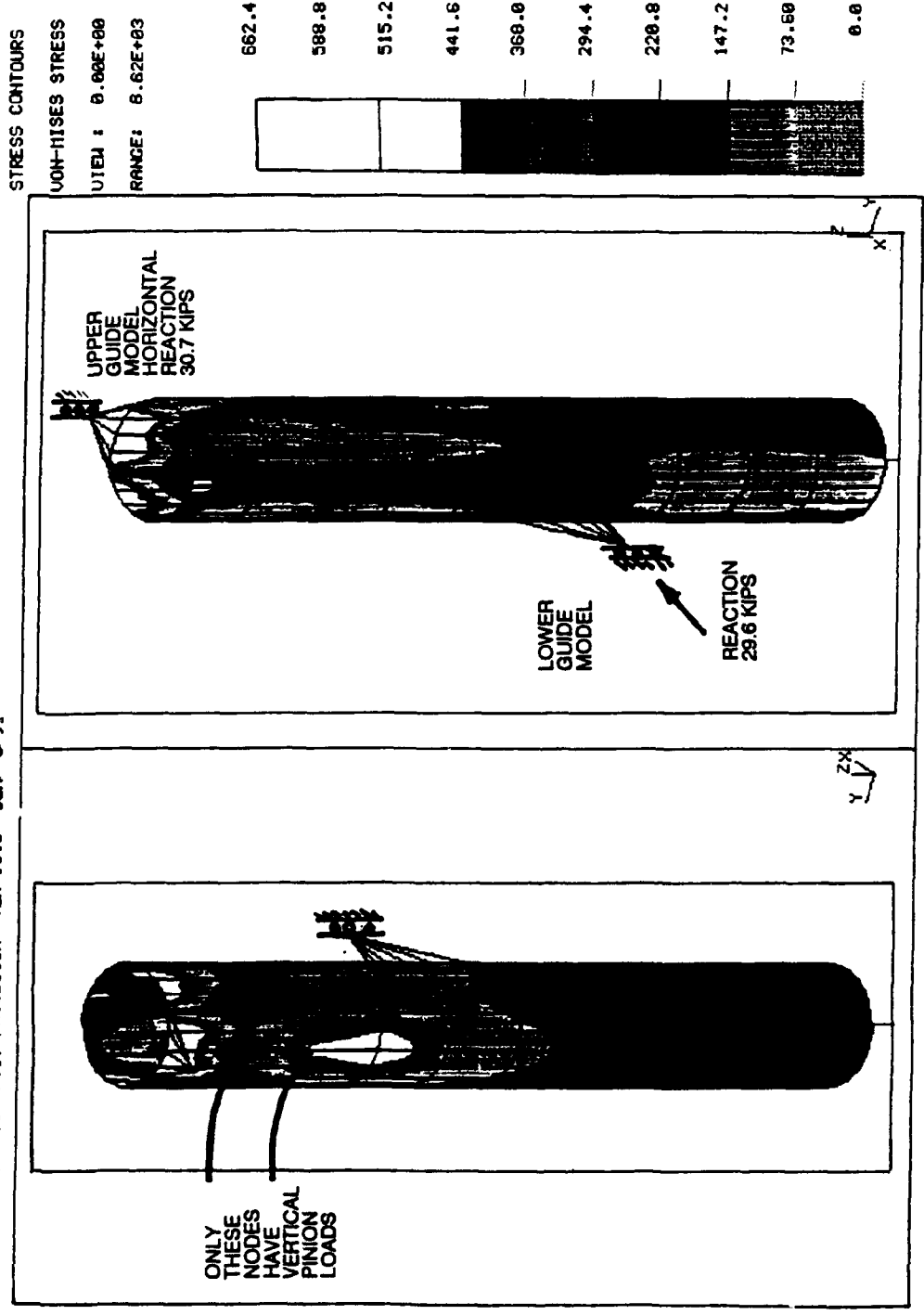

LB011 LINEAR ANALYSIS OF LIFTBOAT LEG SHELL

TOP LAYER

FIGURE A10-4
Run LB06 with 1" walls & only two pinion load points

COLOR VERSIONS OF FIGURES A10-1 THROUGH A10-5 ARE AVAILABLE FROM THE COAST GUARD R&D CENTER

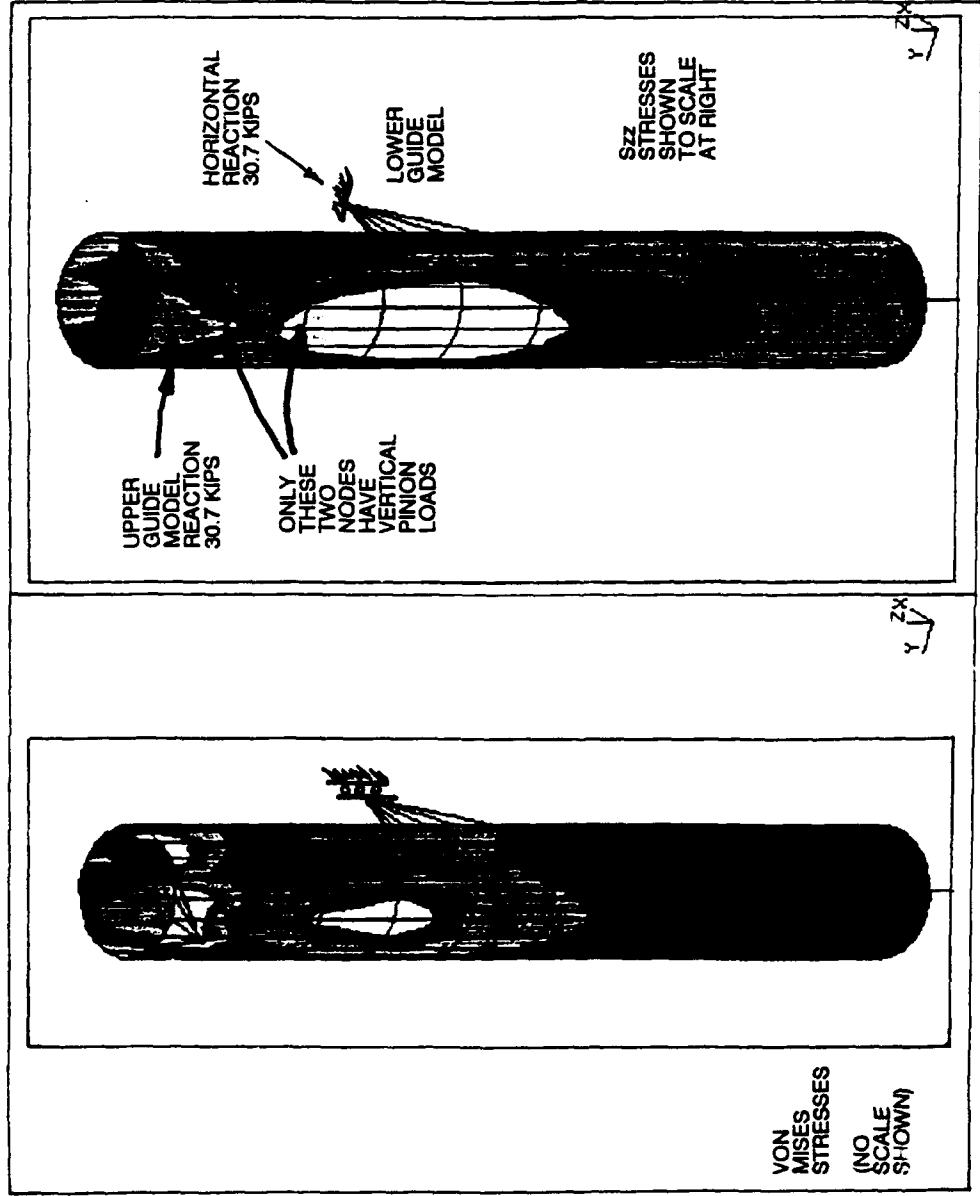

STRESS CONTOURS
 SZZ - STRESSES
 UITEM : -8.14E+03
 RANGE : 1.85E+03

LB011 LINEAR ANALYSIS OF LIFTBOAT LEG SHELL

TOP LAYER

FIGURE A10-5
 Run LB06 with 1" walls & two pinion load points

COLORLED VERSIONS OF FIGURES A10-1 THROUGH A10-5 ARE AVAILABLE FROM THE COAST GUARD R&D CENTER